



**HEWLETT
PACKARD**

INSTALLATION AND VERIFICATION MANUAL

HP 70908A RF SECTION

SERIAL NUMBERS

This manual applies directly to HP 70908A RF Sections with serial numbers prefixed 2713A and below.

**COPYRIGHT © 1987 HEWLETT-PACKARD COMPANY
1212 VALLEY HOUSE DRIVE, ROHNERT PARK, CALIFORNIA 94928-4999 U.S.A.**

**Manual Part Number 70908-90004
Microfiche Part Number 70908-90005**

Printed: AUGUST 1987

CERTIFICATION

Hewlett-Packard Company certifies that this product met its published specifications at the time of shipment from the factory. Hewlett-Packard further certifies that its calibration measurements are traceable to the United States National Bureau of Standards, to the extent allowed by the Bureau's calibration facility, and to the calibration facilities of other International Standards Organization members.

WARRANTY

This Hewlett-Packard instrument product is warranted against defects in material and workmanship for a period of one year from date of shipment. During the warranty period, Hewlett-Packard Company will, at its option, either repair or replace products which prove to be defective.

For warranty service or repair, this product must be returned to a service facility designated by HP. Buyer shall prepay shipping charges to HP and HP shall pay shipping charges to return the product to Buyer. However, Buyer shall pay all shipping charges, duties, and taxes for products returned to HP from another country.

HP warrants that its software and firmware designated by HP for use with an instrument will execute its programming instructions when properly installed on that instrument. HP does not warrant that the operation of the instrument, or software, or firmware will be uninterrupted or error free.

LIMITATION OF WARRANTY

The foregoing warranty shall not apply to defects resulting from improper or inadequate maintenance by Buyer, Buyer-supplied software or interfacing, unauthorized modification or misuse, operation outside of the environmental specifications for the product, or improper site preparation or maintenance.

NO OTHER WARRANTY IS EXPRESSED OR IMPLIED. HP SPECIFICALLY DISCLAIMS THE IMPLIED WARRANTIES OF MERCHANTABILITY AND FITNESS FOR A PARTICULAR PURPOSE.

EXCLUSIVE REMEDIES

THE REMEDIES PROVIDED HEREIN ARE BUYER'S SOLE AND EXCLUSIVE REMEDIES. HP SHALL NOT BE LIABLE FOR ANY DIRECT, INDIRECT, SPECIAL, INCIDENTAL, OR CONSEQUENTIAL DAMAGES, WHETHER BASED ON CONTRACT, TORT, OR ANY OTHER LEGAL THEORY.

ASSISTANCE

Product maintenance agreements and other customer assistance agreements are available for Hewlett-Packard products.

For any assistance, contact your nearest Hewlett-Packard Sales and Service Office.

HP 70000 Modular Measurement System

Documentation Outline

Instruments and modules of the HP 70000 Modular Measurement System require different kinds of documentation. An instrument's master module requires service information on how to install, verify, operate, program, and service the module. A slave module does not require operating or programming information. HP 70000 Modular Measurement System documentation includes these four manuals: Installation and Verification, Operation, Programming, and Technical Reference.

Manuals Supplied with a Module

INSTALLATION AND VERIFICATION MANUAL

Installation and verification topics include installation, specifications, module operation verification, and some troubleshooting information. A slave module Installation and Verification Manual might not provide coverage under all these topics. A master module Installation and Verification Manual provides coverage under all the above topics and in addition might include some system-level information.

OPERATION MANUAL

Operation Manuals usually pertain to multiple- and single-module instrument systems. Topics include module preparation for use, module functions, and softkey definitions.

PROGRAMMING MANUAL

Programming Manuals and Operation Manuals pertain to the same type systems. Programming Manual topics include programming fundamentals and also definitions for remote programming commands.

Service Manual, Available Separately

TECHNICAL REFERENCE

A Technical Reference Manual provides module service information including these topics: performance verification, adjustments, troubleshooting, replaceable parts lists, replacement procedures, schematics, component location diagrams. For ordering information, contact a Hewlett Packard Sales and Service Office.

SAFETY SYMBOLS

The following safety symbols are used throughout this manual and in the instrument. Familiarize yourself with each of the symbols and its meaning before operating this instrument.



Instruction manual symbol. The instrument will be marked with this symbol when it is necessary for the user to refer to the instruction manual in order to protect the instrument against damage. Location of pertinent information within the manual is indicated by use of this symbol in the table of contents.



Indicates dangerous voltages are present. Be extremely careful.

CAUTION

The CAUTION sign denotes a hazard. It calls attention to a procedure which, if not correctly performed or adhered to, could result in damage to or destruction of the instrument. Do not proceed beyond a CAUTION sign until the indicated conditions are fully understood and met.

WARNING

The WARNING sign denotes a hazard. It calls attention to a procedure which, if not correctly performed or adhered to, could result in injury or loss of life. Do not proceed beyond a WARNING sign until the indicated conditions are fully understood and met.

GENERAL SAFETY CONSIDERATIONS

WARNING

BEFORE THIS INSTRUMENT IS SWITCHED ON, make sure it has been properly grounded through the protective conductor of the ac power cable to a socket outlet provided with protective earth contact. Any interruption of the protective (grounding) conductor, inside or outside the instrument, or disconnection of the protective earth terminal can result in personal injury.

WARNING

There are voltages at many points in the instrument which can, if contacted, cause personal injury. Be extremely careful. Any adjustments or service procedures that require operation of the instrument with protective covers removed should be performed only by trained service personnel.

CAUTION

BEFORE THIS INSTRUMENT IS SWITCHED ON, make sure its primary power circuitry has been adapted to the voltage of the ac power source. Failure to set the ac power input to the correct voltage could cause damage to the instrument when the ac power cable is plugged in.

CONTENTS

Chapter 1. General Information	
Introduction	1-1
Description	1-1
Safety Considerations	1-1
Modules Covered by Manual	1-2
Serial Numbers	1-2
Manual Updating Supplement	1-2
Initial Inspection	1-3
Accessories Supplied	1-3
Front/Rear-Panel Features	1-4
Front-Panel Features	1-4
Rear-Panel Features	1-5
Electrostatic Discharge	1-6
Reducing ESD Damage	1-8
Sales and Service Offices	1-8
How to Return the Module for Service	1-8
Original Packaging	1-8
Other Packaging	1-8
Chapter 2. Installation	
Introduction	2-1
Preparation for Use	2-1
Determining the HP-MSIB Address	2-1
Setting the HP-MSIB Address Switch	2-2
Installing the Module	2-3
Connecting the RF Cables	2-3
Chapter 3. Specifications	3-1
Chapter 4. Verification	4-1
Chapter 5. Troubleshooting	
Introduction	5-1
Status Error Indicator	5-1
Error Messages	5-1
Operating Errors	5-1
Hardware-Broken Messages	5-2

LIST OF ILLUSTRATIONS

Figure 1-1. Typical Serial Number Label	1-2
Figure 1-2. Front and Rear Panel Features	1-4
Figure 1-3. Example of a Static-Safe Work Station	1-6
Figure 1-4. Factory Packaging Materials	1-10
Figure 2-1. Typical Address Map	2-2
Figure 2-2. Module Address Switch	2-2
Figure 2-3. Module Installation	2-3
Figure 2-4. Typical Rear-Panel Connections	2-4

LIST OF TABLES

Table 1-1. Accessories Supplied	1-3
Table 1-2. Static-Safe Accessories	1-7
Table 1-3. HP Spectrum Analyzer Sales and Service Offices	1-11
Table 2-1. RF Cables	2-4

Chapter 1

GENERAL INFORMATION

Introduction

This Installation and Verification Manual contains information required to install and verify the HP 70908A RF Module. For information on installing and verifying HP 70000 Modular Spectrum Analyzers, refer to the HP 70900A Installation and Verification Manual.

This manual contains the following five chapters:

- **Chapter 1 General Information** describes module accessories and features.
- **Chapter 2 Installation** provides steps for configuring and installing the module into an HP 70000 Modular Spectrum Analyzer.
- **Chapter 3 Specifications** lists any module specifications and characteristics.
- **Chapter 4 Verification** contains tests required to verify module specifications.
- **Chapter 5 Troubleshooting** explains front-panel error lights and error codes produced by the HP 70908A.

Description

The HP 70908A RF Module is a preselected microwave front-end assembly for use in an HP 70000 Modular Spectrum Analyzer. A complete measuring system includes RF, IF, LO, and Display modules installed into an HP 70000 Series mainframe. The HP 70908A is a variable frequency translator providing image-free coverage from 100 Hz to 22 GHz. The final IF is 21.4 MHz.

Safety Considerations

Before operating this module, read the safety markings on the instrument and the safety instructions in this manual. This module is manufactured and tested according to international safety standards. However, to ensure safe operation of the module and to ensure the personal safety of the user and service personnel, the cautions and warnings in this manual must be heeded. Refer to the summary of safety considerations at the front of this manual.

Modules Covered by Manual

SERIAL NUMBERS

A two-part serial number appears on the mylar label attached to the front frame of your module. The first four digits and the letter constitute the serial number prefix; the last five digits constitute the suffix. See figure 1-1. The prefix is the same for all identical modules; it changes only when a change is made to the module. The suffix, however, is assigned sequentially and is different for each module. The contents of this manual apply to modules with the serial number prefix(es) listed under SERIAL NUMBERS on the title page.

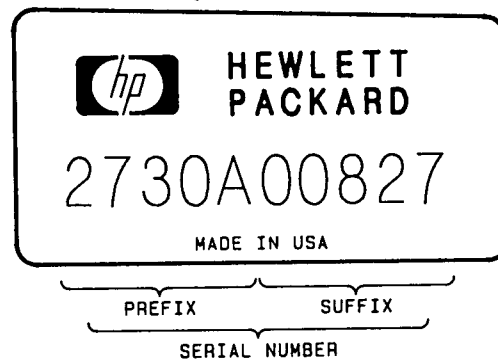

Figure 1-1. Typical Serial Number Label

MANUAL UPDATING SUPPLEMENT

A module manufactured after the printing of this manual might have a serial number prefix that is not listed on the title page. This unlisted serial number prefix indicates that the module is different from those with the serial prefix listed on the title page. The manual for this newer module may be accompanied by a Manual Updating Supplement. This supplement contains change information that explains how to adapt the manual to the newer module.

In addition to change information, the supplement may contain corrections to errors in the manual. To keep this manual as current and accurate as possible, Hewlett-Packard recommends that you periodically request the latest Manual Updating Supplement. The supplement carries a manual identification block that includes the model number, print date of the manual, and manual part number. Complimentary copies of the supplement are available from Hewlett-Packard. Addresses of Hewlett-Packard offices are located at the end of this chapter.

Initial Inspection

Inspect the shipping container for damage. If the shipping container and/or cushioning material is damaged, it should be kept until the contents of the shipment have been checked for completeness and the instrument has been checked mechanically and electrically. (Refer to the Accessories Supplied section in this chapter and to chapter 4, Verification.)

If the contents are incomplete, or if there is mechanical damage or defect, or if the instrument does not pass the operation verification test, notify the nearest Hewlett-Packard office. (A list of Hewlett-Packard Sales and Service Offices appears at the end of this chapter.) If the shipping container is damaged, or if the cushioning material shows signs of stress, notify the carrier as well as the Hewlett-Packard office. Keep the shipping materials for inspection by the carrier. The Hewlett-Packard office will arrange for repair or replacement without waiting for a claim settlement.

Accessories Supplied

The HP 70908A may be ordered separately or as part of a preconfigured spectrum analyzer. When ordered separately, the accessories supplied allow the most common system configurations. Table 1-1 is a list of cables included with the modules. Contact a Hewlett-Packard Sales and Service Office for a description of all cables and terminations currently shipped with the HP 70908A. When ordered with a preconfigured spectrum analyzer, the module comes with RF cables that match the factory configuration.

Table 1-1. Accessories Supplied

Accessory	HP Part Number
Coax RF Cables:	
SMB (f) connectors, 50 Ω , 9 cm (3-1/2 in.)	5061-9015
SMB (f) connectors, 50 Ω , 19 cm (7-1/2 in.)	5061-9017
SMB (f) connectors, 50 Ω , 39 cm (15-3/8 in.)	5061-9021
SMA (m) connectors, 50 Ω , 51 cm (20 in.)	5061-9038

Front/Rear-Panel Features

Figure 1-2 illustrates the HP 70908A front and rear panels, and the following subsections describe each feature.

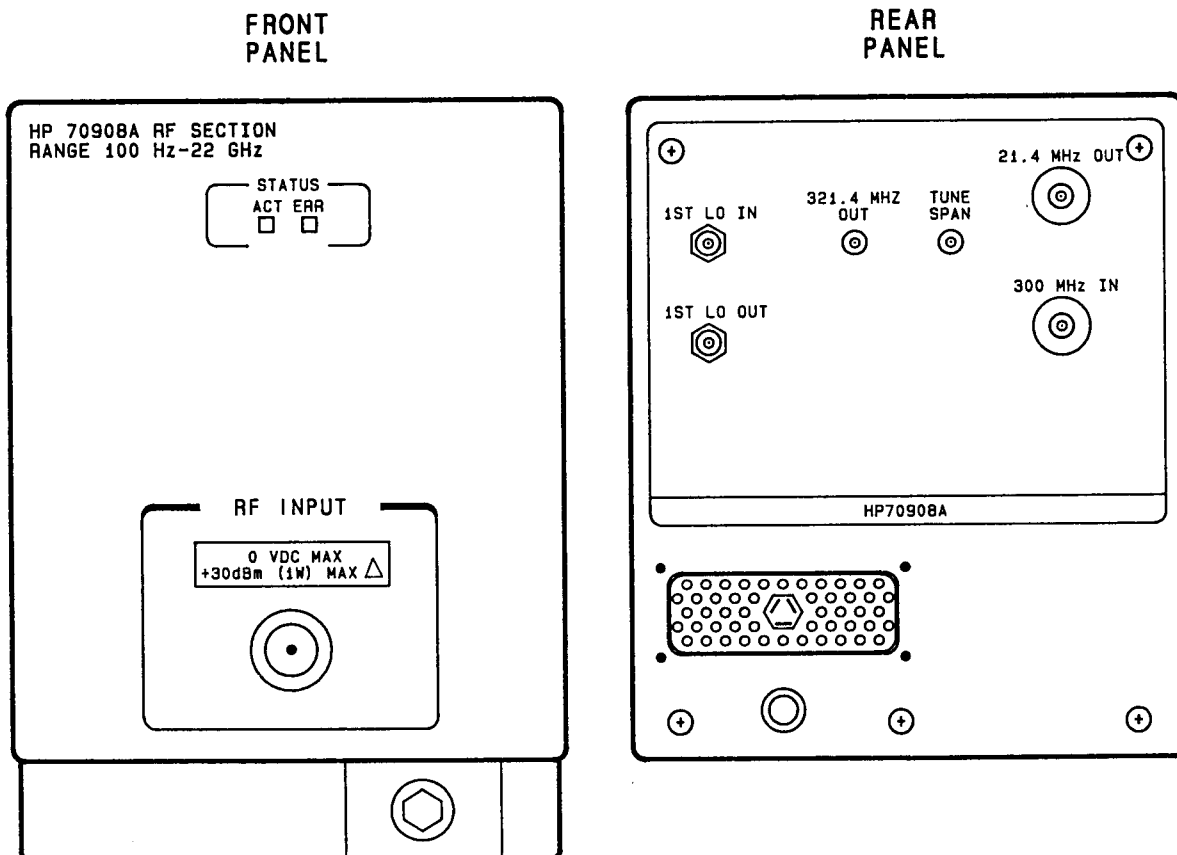

Figure 1-2. Front and Rear-Panel Features

FRONT-PANEL FEATURES

The two front-panel LEDs indicate the status of the module. The LEDs should turn on and off during the system self-test.

STATUS ACT Indicator

The STATUS ACT indicator LED lights when the HP 70908A becomes active.

STATUS ERR Indicator

The STATUS ERR indicator LED lights when there is a problem (an error) related to the module.

RF INPUT Connector

The RF INPUT Type N (f) connector provides a 50 Ω input impedance.

Module Latch

The module hex-nut latch secures the module in the mainframe. The latch operation requires an 8 mm hex-ball driver. Refer to chapter 2 for instructions on installing the module.

REAR-PANEL FEATURES**1ST LO IN**

This input connector receives a 3.0 to 6.6 GHz, +1.5 to +12 dBm, signal from the HP 70900A Local Oscillator module. This signal serves as the HP 70908A lowband 1st LO. For the highband 1st LO, an HP 70908A multiplies the 3.0–6.6 GHz signal by 1, 2, or 3, thus providing fundamental mixing throughout the instrument's frequency range.

1ST LO OUT

This output connector provides the 1ST LO IN signal as an auxiliary output. Output power is approximately +1.5 to +12 dBm. You should terminate the 1ST LO OUT with a 50 Ω load when it is not connected to some input connector.

21.4 MHz OUT

This is the HP 70908A 21.4 MHz third converter output signal. The 21.4 MHz is the system's final IF, and is thus the IF module input signal.

300 MHz IN

This input connector receives the HP 70900A Local Oscillator 300 MHz reference signal, which serves as the HP 70908A third converter local oscillator signal.

TUNE SPAN

This input connector receives the HP 70900A Local Oscillator module TUNE+SPAN sweep voltage, which tracks the 1ST LO IN frequency. After some compensation processing, this sweep voltage tunes the HP 70908A YIG.

321.4 MHz OUT

By means of a softkey or a remote command, the user selects either the 321.4 MHz highband IF or the 21.4 MHz lowband IF. Selecting the highband IF automatically bypasses the third converter filters and mixer.

Mainframe/Module Connector

The 50-pin module connector mates with a 50-pin mainframe connector. This interface provides the module with access to the mainframe power supply and the HP 70000 system communication buses (HP-IB and HP-MSIB).

Electrostatic Discharge

Electrostatic discharge (ESD) can damage or destroy electronic components. All work performed on electronic assemblies should be at a static-free work station. Figure 1-3 is an example of a static-safe work station using the following two types of ESD protection:

- conductive table mat and wrist-strap combination
- conductive floor mat and heel-strap combination

Table 1-2 lists static-safe accessories that can be obtained from Hewlett-Packard.

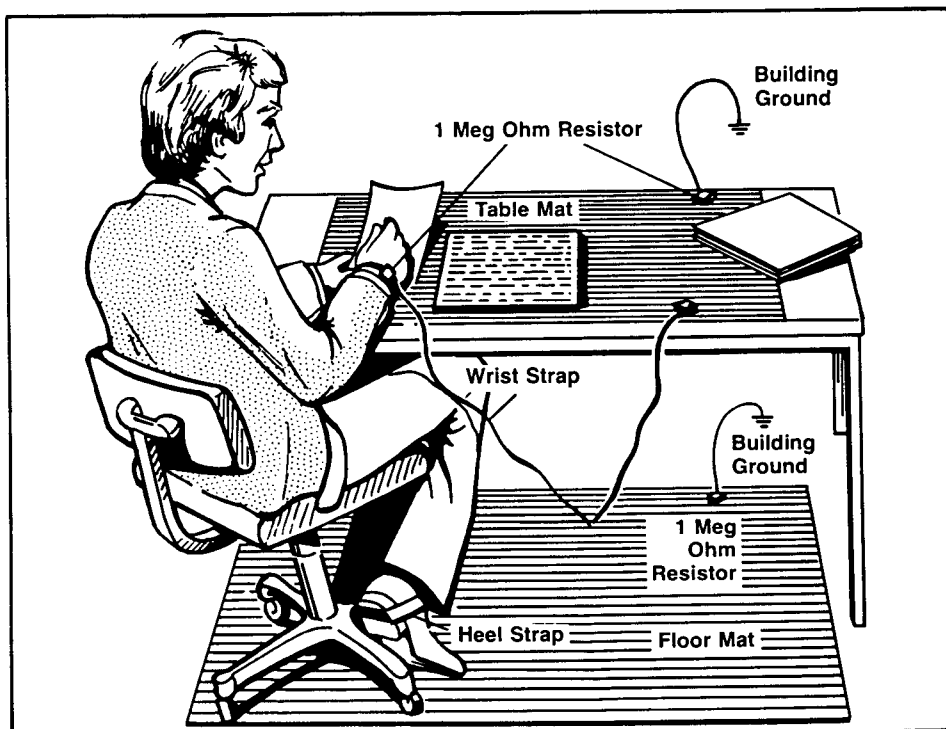

Figure 1-3. Example of a Static-Safe Work Station

Table 1-2. Static-Safe Accessories

HP Part Number	Description
<p>Note: The following items can be ordered through any Hewlett-Packard Sales and Service Office.</p>	
9300-0797	3M static control mat, 0.6m x 1.2m (2 ft. x 4 ft.) 4.6m (15 ft.) ground wire wrist strap and attachment cord
9300-0980	Wrist strap cord, 1.5m (5 ft.)
9300-0985	Wrist strap (large)
9300-0986	Wrist strap (small)
9300-1169	ESD heel strap (reusable 6 to 12 months)
9300-0793	Shoe ground strap (one-time use only)
<p>Note: The following ESD accessories can be ordered only from: Hewlett-Packard Company Computer Supplies Operation 1320 Kifer Road Sunnyvale, CA 94086 Phone: (408) 738-8858</p>	
92175A	Black, hard-surface, static control mat, 1.2m x 1.5m (4 ft. x 5 ft.)
92175B	Brown, soft-surface, static control mat, 2.4m x 1.2m (8 ft. x 4 ft.)
92175C	Small, black, hard-surface, static control mat, 1.2m x 0.9m (4 ft. x 3 ft.)
92175T	Tabletop static control mat, 58 cm x 76 cm (23 in. x 30 in.)
92176A	Anti-static carpet, natural color, 1.8m x 1.2m (6 ft. x 4 ft.)
92176B	Anti-static carpet, natural color, 2.4m x 1.2m (8 ft. x 4 ft.)
92176C	Anti-static carpet, russet color, 1.8m x 1.2m (6 ft. x 4 ft.)
92176D	Anti-static carpet, russet color, 2.4m x 1.2m (8 ft. x 4 ft.)

REDUCING ESD DAMAGE

The following suggestions may help reduce ESD damage that occurs during testing and servicing operations.

- Before connecting any coaxial cable to an analyzer connector for the first time each day, momentarily short together the center and outer conductors.
- Personnel should be grounded with a resistor-isolated wrist strap before touching the center pin of any connector and before removing any assembly from the unit.
- Be sure that all instruments are properly earth-grounded to prevent a buildup of static charge.

Sales and Service Offices

Hewlett-Packard Sales and Service Offices provide complete support for HP 70000 Modular Spectrum Analyzers. To obtain servicing information or to order replacement parts, contact the nearest Hewlett-Packard Sales and Service Office listed in table 1-3. In any correspondence or telephone conversations, refer to the module by its model number.

How to Return the Module for Service

If you are returning the module to Hewlett-Packard for servicing, fill in and attach a blue service tag. Service tags are supplied at the end of this manual.

Please be as specific as possible about the nature of the problem. If you have recorded any error messages that appeared on the screen, or if you have any other specific data on the performance of the module, please send a copy of this information with the unit.

ORIGINAL PACKAGING

Before shipping, pack the unit in the original factory packaging materials. If the original materials were not retained, identical packaging materials are available through any Hewlett-Packard office. Figure 1-4 illustrates the factory packaging materials.

OTHER PACKAGING

A rectangular box with a decorative, wavy border containing the word "CAUTION" in all caps.

Module damage can result from using packaging materials other than those specified. Never use styrene pellets in any shape as packaging materials. They do not adequately cushion the equipment or prevent it from shifting in the carton. They also cause equipment damage by generating static electricity.

You can repackage the module with commercially available materials, as follows:

1. Attach a completed service tag to the module.
2. Wrap the module in anti-static plastic to reduce the possibility of damage caused by electrostatic discharge.
3. Use a strong shipping container. A double-walled, corrugated cardboard carton with 159-kg (350-lb) bursting strength is adequate. The carton must be both large enough and strong enough to accommodate the module. Allow at least three to four inches on all sides of the module for packing material.
4. Surround the module with three to four inches of packing material to cushion shock and prevent the equipment from moving in the carton. If packing foam is not available, the best alternative is S.D.-240 Air Cap™ from Sealed Air Corporation (Commerce, California, 90001). Air Cap looks like a plastic sheet filled with 1-1/4 inch air bubbles. Use the pink-colored Air Cap to reduce static electricity. Wrapping the module several times in this material should protect the module and prevent it from moving in the carton.
5. Seal the shipping container securely with strong nylon adhesive tape.
6. Mark the shipping container "FRAGILE, HANDLE WITH CARE".
7. Retain copies of all shipping papers.

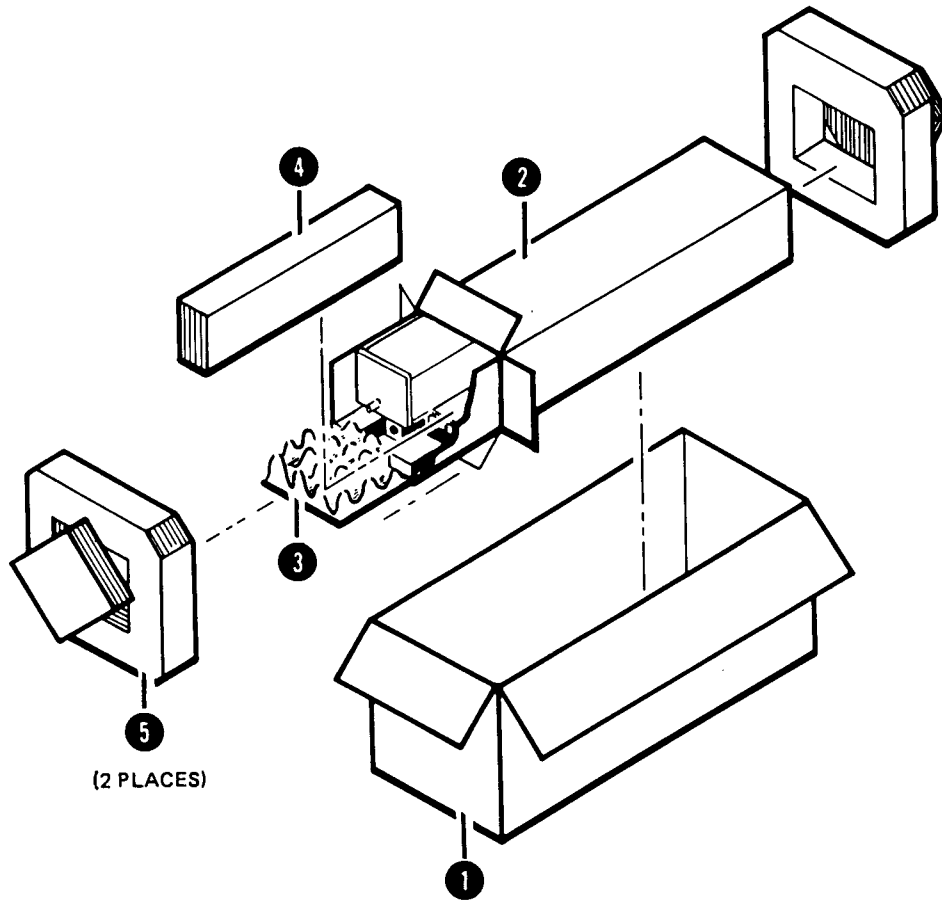

ITEM	QTY	HP PART NO.	DESCRIPTION
①	1	9211-5118	CARTON-OUTER
②	1	9211-5119	CARTON-INNER
③	1	5180-2369	CARTON-SLIDER
④	1	4280-0493	FOAM INSERT (FOR QUANTITY SEE TEXT)
⑤	2	5180-2370	FOAM PADS

Figure 1-4. Factory Packaging Materials

Table 1-3. HP Spectrum Analyzer Sales and Service Offices (1 of 2)

<p>IN THE UNITED STATES</p> <p>California Hewlett-Packard Co. P.O. Box 4230 1421 South Manhattan Ave. Fullerton, CA 92631 (714) 999-6700</p> <p>Hewlett-Packard Co. 333 Logue Ave. Mountain View, CA 94040 (415) 969-0880</p> <p>Colorado Hewlett-Packard Co. 24 Inverness Place, East Englewood, CO 80112 (303) 649-5000</p> <p>Georgia Hewlett-Packard Co. P.O. Box 105005 2000 South Park Place Atlanta, GA 30339 (404) 955-1500</p> <p>Illinois Hewlett-Packard Co. 5201 Tollview Drive Rolling Meadows, IL 60008 (312) 255-9800</p> <p>New Jersey Hewlett-Packard Co. 120 W. Century Road Paramus, NJ 07653 (201) 265-5000</p> <p>Texas Hewlett-Packard Co. 930 E. Campbell Rd. Richardson, TX 75081 (214) 231-6101</p>	<p>IN AUSTRALIA Hewlett-Packard Australia Ltd. 31-41 Joseph Street Blackburn, Victoria 3130 895-2895</p> <p>IN CANADA Hewlett-Packard (Canada) Ltd. 17500 South Service Road Trans-Canada Highway Kirkland, Quebec H9J 2X8 (514) 697-4232</p> <p>IN FRANCE Hewlett-Packard France F-91947 Les Ulis Cedex Orsay (6) 907-78-25</p> <p>IN GERMAN FEDERAL REPUBLIC Hewlett-Packard GmbH Vertriebszentrale Frankfurt Berner Strasse 117 Postfach 560 140 D-6000 Frankfurt 56 (0611) 50-04-1</p> <p>IN GREAT BRITAIN Hewlett-Packard Ltd. King Street Lane Winnersh, Wokingham Berkshire RG11 5AR 0734 784774</p> <p>IN OTHER EUROPEAN COUNTRIES Hewlett-Packard (Schweiz) AG Allmend 2 CH-8967 Widen (Zurich) (0041) 57 31 21 11</p>
---	---

Table 1-3. HP Spectrum Analyzer Sales and Service Offices (2 of 2)

<p>IN JAPAN Yokogawa-Hewlett-Packard Ltd. 29-21 Takaido-Higashi, 3 Chome Suginami-ku Tokyo 168 (03) 331-6111</p> <p>IN PEOPLE'S REPUBLIC OF CHINA China Hewlett-Packard, Ltd. P.O. Box 9610, Beijing 4th Floor, 2nd Watch Factory Main Bldg. Shuang Yu Shu, Bei San Huan Rd. Beijing 28-0567</p> <p>IN SINGAPORE Hewlett-Packard Singapore Pte. Ltd. #08-00 Inchcape House 450-2 Alexandra Road Alexandra P.O. Box 58 Singapore, 9115 4731788</p>	<p>IN TAIWAN Hewlett-Packard Taiwan 8th Floor, Hewlett-Packard Building 337 Fu Hsing North Road Taipei (02) 712-0404</p> <p>IN ALL OTHER LOCATIONS Hewlett-Packard Inter-Americas 3200 Hillview Avenue Palo Alto, California 94304</p>
--	--

Chapter 2

INSTALLATION

Introduction

This chapter provides information on installing the HP 70908A into an HP 70000 Modular Spectrum Analyzer mainframe. The information presented is general in nature. For more detailed information about spectrum analyzer configuration and HP-MSIB (Hewlett-Packard Modular System Interface Bus) addressing, refer to the HP 70900A Local Oscillator Installation and Verification Manual.

Preparation for Use

Installing the module requires the following steps:

- determining the HP-MSIB address
- setting the HP-MSIB address switch
- installing the module
- connecting the RF cables

DETERMINING THE HP-MSIB ADDRESS

HP 70000 Modular Spectrum Analyzer components have HP-IB access through the HP 70900A Local Oscillator module. The HP 70900A communicates with the HP 70908A by means of HP-MSIB; therefore, the HP 70908A requires an HP-MSIB address.

The HP 70908A factory preset address is 4.18 (row 4, column 18). Figure 2-1 illustrates a typical address map for a spectrum analyzer. It shows the relationship between modules and factory-preset HP-MSIB addresses. Normally, the HP 70908A address does not require changing. However, the address may have to be changed if factory preset addresses of other modules have been changed.

Changing the HP-MSIB address requires an understanding of HP-MSIB addressing rules. For information on determining and assigning HP-MSIB addresses, refer to the HP 70900A Local Oscillator Installation and Verification Manual.

ADDRESSING EXAMPLE

7				
6				
5				
R O W 4		70908A RF SECT		
3				
2				
1		70902A IF SECT		
Ø		70900A LO/CTLR HP-1B18		
	17	18	19	20
	COLUMN			

THE HP 70001A MAINFRAME DOES NOT HAVE AN HP-MSIB ADDRESS. THE USUAL ADDRESS FOR THE HP 70205A OR HP 70206A DISPLAY IS ROW Ø, COLUMN 4.

Figure 2-1. Typical Address Map

SETTING THE HP-MSIB ADDRESS SWITCH

A module address change requires the following three steps:

1. Locate the address switches on the left side-panel of the module. See figure 2-2 for an example of the switches.
2. Set the three switches labeled "row" to the binary value of the module's HP-MSIB row number. For example, if the row value is 4, set the switches to binary 100 as shown in figure 2-2.
3. Set the five switches labeled "column" to the binary value of the module's HP-MSIB column number. For example, if the column value is 18, set the switches to binary 10010 as shown in figure 2-2.

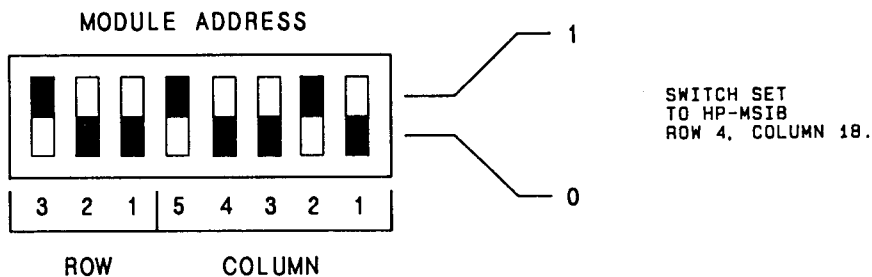

Figure 2-2. Module Address Switch

INSTALLING THE MODULE

Follow the steps below to install the module in the mainframe:

1. Set the mainframe LINE switch to OFF. See figure 2-3.
2. Open the mainframe front-panel door and slide the module into the mainframe. Modules can be placed in any order. Longer cables may have to be ordered for some configurations.
3. Press against the module front panel while tightening the hex-nut latch with an 8 mm hex-ball driver.
4. Close the mainframe front-panel door.

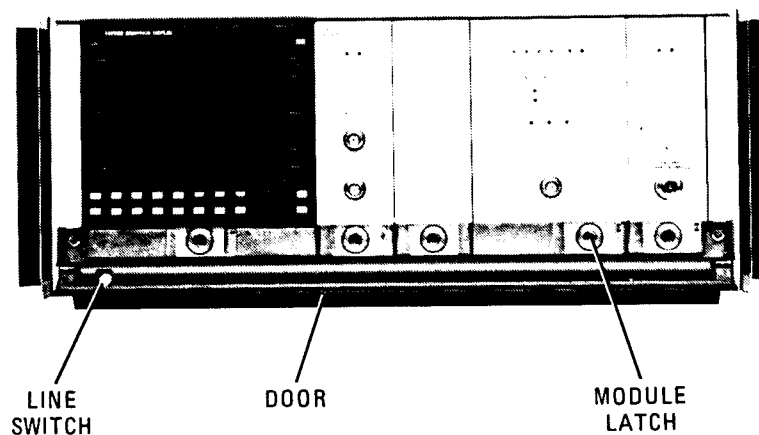

Figure 2-3. Module Installation

CONNECTING THE RF CABLES

Figure 2-4 illustrates typical rear-panel connections for the RF cables. Use the cables listed in table 2-1 to make the connections in the steps below.

In table 2-1, cables labeled 1/8 span will connect between 1/8 size modules in adjacent positions. Cables labeled 7/8 span will connect between a module in the first mainframe position and a module seven positions away in the eighth mainframe position. Modules that are not shipped in a preconfigured spectrum analyzer come with one each of the 1/8, 3/8, and 7/8 span cables.

Cables marked SMB have snap-on connectors. Cables marked SMA have threaded connectors which require the use of a 5/16-inch wrench.

CAUTION

Use no more than 6 inch-pounds of torque when tightening SMA connectors.

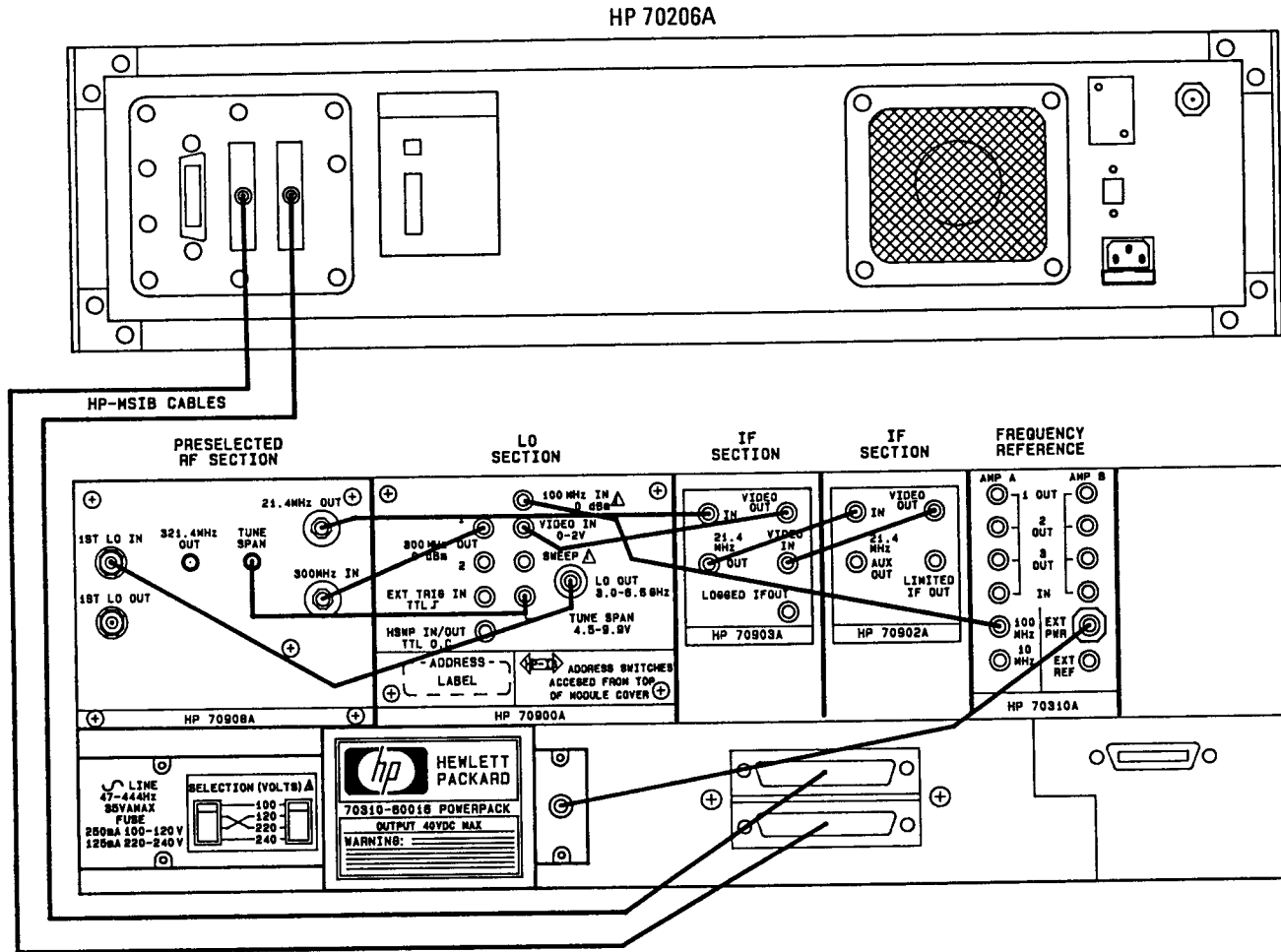

Figure 2-4. Typical Rear-Panel Connections

1. Connect one of the SMB cables listed in table 2-1 between the RF module's 21.4 MHz OUT jack and the IF module's 21.4 MHz IN jack.
2. Use an SMB coax cable to connect the RF module's 300 MHz jack with the LO module's 300 MHz OUT #1 jack.
3. Connect the RF module's 1ST LO IN jack with the LO module's LO OUT jack. Use the SMA coax cable supplied in a package labeled HP 5061-9038.

Table 2-1. RF Cables

Type	Length	HP Part Number
Coax, SMB (f), 50Ω	1/8 span, 9 cm (3-1/2 in.)	5061-9015
	2/8 span, 14 cm (5-1/2 in.)	5061-9016
	3/8 span, 19 cm (7-1/2 in.)	5061-9017
	4/8 span, 24 cm (9-3/8 in.)	5061-9018
	5/8 span, 29 cm (11-1/2 in.)	5061-9019
	6/8 span, 34 cm (13-3/8 in.)	5061-9020
	7/8 span, 39 cm (15-3/8 in.)	5061-9021
Coax, SMA (m), 50Ω	51 cm (20 in.)	5061-9038
Semi-rigid, SMA (m), 50Ω	3/8 span	5021-5450

Chapter 3

SPECIFICATIONS

There are no specifications for HP 70908A RF modules. For system-level specifications and characteristics, refer to the local oscillator's Installation and Verification Manual.

Chapter 4

VERIFICATION

This chapter normally contains performance verification tests which test the electrical performance of the module against its specifications. Since there are no HP 70908A module specifications, no performance verification tests apply.

Chapter 5

TROUBLESHOOTING

Introduction

This chapter provides information on the front-panel STATUS ERR (error) indicator light and the error messages produced by the HP 70908A. Refer to the HP 70908A RF Section Technical Reference for component-level troubleshooting and service.

Status Error Indicator

A STATUS ERR (Error) indicator LED is located on the module's front panel. If the LED flashes at a 1 Hz rate, the module cannot communicate over the HP-MSIB and is probably faulty. If the error indicator LED of more than one of the spectrum analyzer's modules flashes at a 1 Hz rate, refer to the HP 70900A Local Oscillator Installation and Verification Manual.

NOTE

It is possible, but not probable, that a module may disrupt all HP-MSIB communication without its own error indicator flashing.

Error Messages

Spectrum analyzer error messages generated by the HP 70908A are listed in this section. The messages are grouped by functional category; each category has its own series of numbers. Refer to the HP 70900A Local Oscillator Installation and Verification Manual for a complete listing of all system error messages.

OPERATING ERRORS (2000–2999)

Operating errors are generated when the spectrum analyzer is used incorrectly. This usually occurs during remote operation. Refer to the HP 70000 Spectrum Analyzer Operation Manual and HP 70000 Spectrum Analyzer Programming Manual for information on both manual and remote spectrum analyzer operations.

2001, Illegal command (Illegal cmd)

The A12 Controller Assembly microprocessor received a command it did not recognize. If this was not a user error, suspect the A12 assembly or the cable connecting that assembly to the rear-panel connector.

2002, Illegal parameter

This error is similar to error 2001.

2006, Parm out of range

This error is similar to error 2001.

2009, Protocol error

This error is similar to error 2001.

HARDWARE-BROKEN MESSAGES (7000–7999)

Hardware-broken messages indicate the module may have faulty hardware. The messages report the module's model number and HP-MSIB address along with the error message.

7000, ROM Check error

This error occurs when the programmed checksum of the lower half of the addresses of ROM A12U7 does not agree with the computed checksum. If replacing A12U7 does not fix the problem, suspect the A12 assembly.

7002, First LO unlevelled

The 1st LO signal is unlevelled. Verify the rear-panel 1ST LO IN connection. The acceptable power into the A1 LO Leveling Amplifier is +4 to +12 dBm.

7003, Second LO unlocked

The 2nd LO phase-lock loop is not phase-locked to the 300 MHz reference signal. Verify the rear-panel 300 MHz IN connection. Suspect the A9 assembly.

7004, 300 MHz error

The power is low at the output of the A11 300 MHz amplifier, stage five.

7009, ROM #2 check error

This error occurs when the programmed checksum of the upper half of the addresses of ROM A12U7 does not agree with the computed checksum. If replacing A12U7 does not fix the problem, suspect the A12 assembly.

7033, Power supply fault

There is a problem with at least one of the power supply voltages on the A10 Power Supply/Driver Assembly.

7074, Discriminator unlock

An unlocked discriminator loop could result from a problem with the HP 70900A Local Oscillator module. To isolate the problem, perform the HP 70900A Tune+Span Offset Adjustment followed by the YTO Linearity Performance Test. If the YTO Linearity Performance Test fails, perform the HP 70900A YTO Frequency Endpoints Adjustment again followed by the YTO Linearity Performance Test. If YTO Linearity passes in either case, suspect the HP 70908A module.

7076, Multiplier unlevelled

This error usually indicates a low output voltage from the A2 LO Multiplier.

7078, Tune+Span error

The Tune+Span voltage on the A10 Power Supply/Driver Assembly is low. Verify the rear-panel TUNE SPAN connection. If the connection is not at fault, suspect the A10 or A12 assemblies.

