

Agilent 71501D
Eye-Diagram Analysis
User's Guide

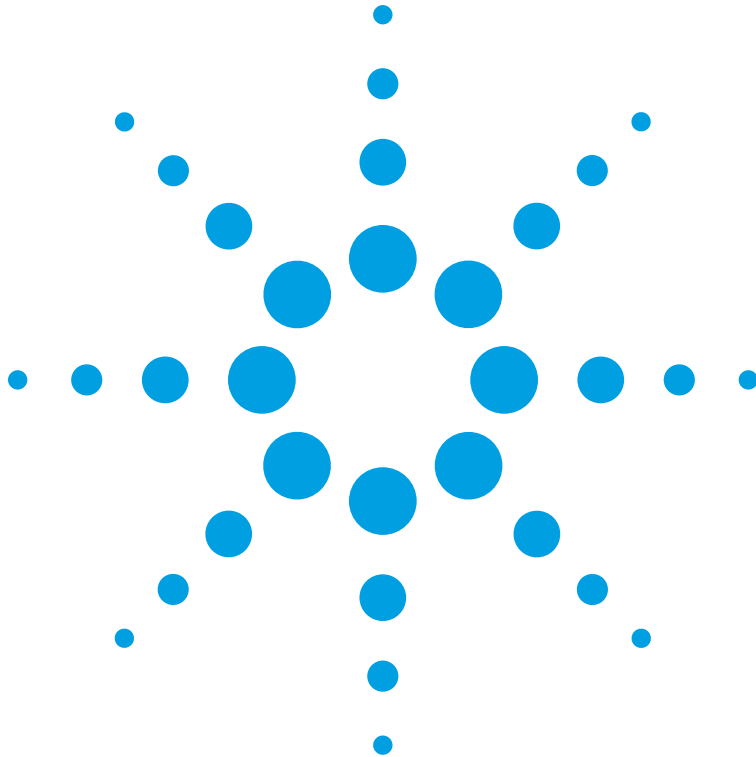

Agilent Technologies

© Copyright
Agilent Technologies 2002
All Rights Reserved. Reproduction, adaptation, or translation without prior written permission is prohibited, except as allowed under copyright laws.

Agilent Part No. 70874-90023
Printed in USA
May 2002

Agilent Technologies
Lightwave Division
3910 Brickway Boulevard,
Santa Rosa, CA 95403, USA

Notice.

The information contained in this document is subject to change without notice. Companies, names, and data used in examples herein are fictitious unless otherwise noted. Agilent Technologies makes no warranty of any kind with regard to this material, including but not limited to, the implied warranties of merchantability and fitness for a particular purpose. Agilent Technologies shall not be liable for errors contained herein or for incidental or consequential damages in connection with the furnishing, performance, or use of this material.

Restricted Rights Legend.

Use, duplication, or disclosure by the U.S. Government is subject to restrictions as set forth in subparagraph (c) (1) (ii) of the Rights in Technical Data and Computer Software clause at DFARS 252.227-7013 for DOD agencies, and subparagraphs (c) (1) and (c) (2) of the Commercial Computer Software Restricted Rights clause at FAR 52.227-19 for other agencies.

Exclusive Remedies.

The remedies provided herein are buyer's sole and exclusive remedies. Agilent Technologies shall not be liable for any direct, indirect, special, incidental, or consequential damages, whether based on contract, tort, or any other legal theory.

Safety Symbols.

CAUTION

The *caution* sign denotes a hazard. It calls attention to a procedure which, if not correctly performed or adhered to, could result in damage to or destruction of the product. Do not proceed beyond a caution sign until the indicated conditions are fully understood and met.

WARNING

The *warning* sign denotes a hazard. It calls attention to a procedure which, if not correctly performed or adhered to, could result in injury or loss of life. Do not proceed beyond a warning sign until the indicated conditions are fully understood and met.



The instruction manual symbol. The product is marked with this warning symbol when it is necessary for the user to refer to the instructions in the manual.





The laser radiation symbol. This warning symbol is marked on products which have a laser output.



The AC symbol is used to indicate the required nature of the line module input power.

 | The ON symbols are used to mark the positions of the instrument power line switch.

 ○ The OFF symbols are used to mark the positions of the instrument power line switch.

 The CE mark is a registered trademark of the European Community.

 The CSA mark is a registered trademark of the Canadian Standards Association.

 The C-Tick mark is a registered trademark of the Australian Spectrum Management Agency.

ISM1-A This text denotes the instrument is an Industrial Scientific and Medical Group 1 Class A product.

Typographical Conventions.

The following conventions are used in this book:

Key type for keys or text located on the keyboard or instrument.

Softkey type for key names that are displayed on the instrument's screen.

Display type for words or characters displayed on the computer's screen or instrument's display.

User type for words or characters that you type or enter.

Emphasis type for words or characters that emphasize some point or that are used as place holders for text that you type.

General Safety Considerations

This product has been designed and tested in accordance with the standards listed on the Manufacturer's Declaration of Conformity, and has been supplied in a safe condition. The documentation contains information and warnings that must be followed by the user to ensure safe operation and to maintain the product in a safe condition.

Install the instrument according to the enclosure protection provided.

This instrument does not protect against the ingress of water.

This instrument protects against finger access to hazardous parts within the enclosure.

WARNING

If this product is not used as specified, the protection provided by the equipment could be impaired. This product must be used in a normal condition (in which all means for protection are intact) only.

WARNING

No operator serviceable parts inside. Refer servicing to qualified service personnel. To prevent electrical shock do not remove covers.

WARNING

This is a Safety Class 1 Product (provided with a protective earthing ground incorporated in the power cord). The mains plug shall only be inserted in a socket outlet provided with a protective earth contact. Any interruption of the protective conductor inside or outside of the instrument is likely to make the instrument dangerous. Intentional interruption is prohibited.

WARNING

To prevent electrical shock, disconnect the instrument from mains before cleaning. Use a dry cloth or one slightly dampened with water to clean the external case parts. Do not attempt to clean internally.

WARNING

For continued protection against fire hazard, replace line fuse only with same type and ratings (type nA/nV). The use of other fuses or materials is prohibited.

General Safety Considerations

CAUTION

Fiber-optic connectors are easily damaged when connected to dirty or damaged cables and accessories. The Agilent 71501D's front-panel input connector is no exception. When you use improper cleaning and handling techniques, you risk expensive instrument repairs, damaged cables, and compromised measurements. Before you connect any fiber-optic cable to the Agilent 71501D clean it thoroughly.

CAUTION

This product is designed for use in Installation Category II and Pollution Degree 2 per IEC 61010-1C and 664 respectively.

CAUTION

Always use the three-prong ac power cord supplied with this instrument. Failure to ensure adequate earth grounding by not using this cord may cause instrument damage.

CAUTION

This instrument has autoranging line voltage input. Be sure the supply voltage is within the specified range.

CAUTION

Use of controls or adjustment or performance of procedures other than those specified herein may result in hazardous radiation exposure.

1 Getting Started

Steps for Setting Up Eye-Diagram Analysis 1-4

2 Application Tutorials

Tutorial 1: Measure Eye-Parameters 2-4

Tutorial 2: Measure in Optical Power Units 2-8

Tutorial 3: Measure Extinction Ratios on Low-Level Signals 2-10

Tutorial 4: Measure Laser Turn-on Delay 2-13

Tutorial 5: Use Software Filters 2-15

Tutorial 6: Test to Industry Standards 2-19

Tutorial 7: Default and Custom Mask or
Limit Line Testing 2-23

Tutorial 8: Display the Data Pattern 2-27

Tutorial 9: Constructing a Low-Pass Filter from a Transfer Function 2-30

Tutorial 10: Create a Vertical Histogram 2-36

Tutorial 11: Create a Horizontal Histogram 2-41

3 Eye-Diagram Analyzer Reference

Performing Eye-Diagram Measurements 3-3

Generating Histograms 3-7

Masks and Limit Lines 3-9

Eye-Diagram Menu Maps 3-12

Agilent 70820A Menus 3-14

Controlling the Display 3-16

Calibrating the Eye-Diagram Analyzer 3-23

Displaying Traces 3-25

Using Markers 3-30

Applying Mask Testing 3-31

Saving to Mass Storage 3-34

Creating Copies of the Display 3-47

Agilent 70820A User-Corrections 3-49

Agilent 70820A Calibration 3-61

4 Programming Commands

Introduction 4-3

Contents

5 Specifications and Characteristics

Vertical Specifications 5-3

Input Channel Specifications 5-4

Trigger Specifications 5-5

Trigger Specifications 5-6

Horizontal Specifications 5-7

Declaration of Conformity 5-8

Getting Started

Getting Started with the Eye-Diagram Analyzer

In this chapter, you will find information on the following topics:

- [Steps for Setting Up Eye-Diagram Analysis](#) 1-4
- [Step 1. Connect the Equipment](#) 1-12
- [Step 2. Load the Personality](#) 1-16
- [Step 3. Complete the Installation Using the Screen Instructions](#) 1-19
- [Step 4. Set Up the Measurement Conditions](#) 1-22
- [Optional Step. Save Instrument State as Preset State](#) 1-26

The Agilent 71501D Eye-Diagram Analysis

You can configure the 71501D system as a high-speed eye-diagram analyzer using Option 005 eye-diagram analysis software. This software allows the system to operate similar to a high-speed sampling oscilloscope such as the Agilent 86100A Infiniium DCA.

The 71501D can perform eye-diagram analysis such as extinction-ratio testing and mask testing. In addition, the software allows the system to operate in Agilent Eyeline mode. In eyeline mode the eye-diagram display shows continuous traces instead of synchronous dots. This allows pattern dependent effects to be investigated. For example, the trace leading to a mask violation can be captured and displayed. The eyeline eye-diagram can take advantage of trace averaging. Therefore, very small energy signals can be extracted from broadband noise. Finally, eye-diagrams can be analyzed using software filters. Fourth-order Bessel-Thompson filters can be easily designed for virtually any data rate allowing analysis without having to actually construct a hardware filter.

The custom keypad

The eye-diagram analyzer comes with a custom keypad that snaps into the front panel of 70004A displays. The keypad gives you quick access to common instrument functions. (Each of these functions can also be accessed using the normal softkey menus.)

If you have the custom keypad, practice using it. You will find that the time required, for many of the procedures in this book, will be significantly reduced.

CAUTION

If you need to remove the custom keypad, do not pry it out. Simply push the tip of a small flat-blade screwdriver straight into the removal hole, and the keypad will pop out.

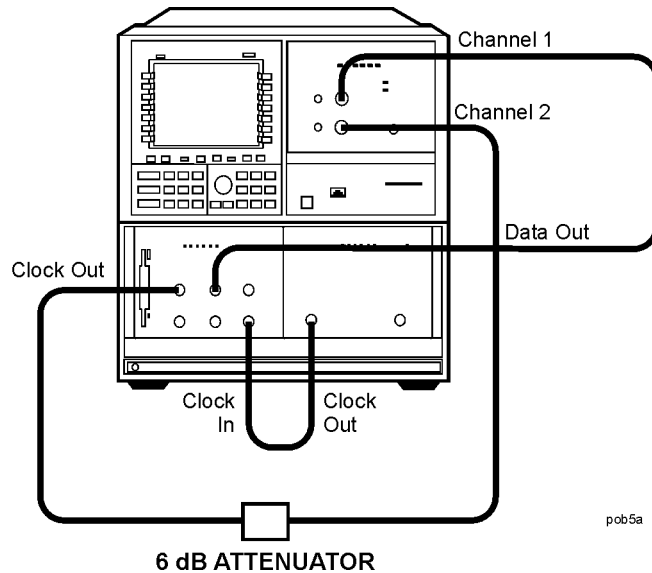

Steps for Setting Up Eye-Diagram Analysis

- 1 Connect the equipment.
- 2 Load the eye-diagram personality.
- 3 Complete the installation using the self-guided screens.
- 4 Set up the measurement conditions.

Connect the Equipment

You can connect the equipment in three possible configurations:

- With 70841A/B pattern generator and 70311 clock source modules. This is the preferred configuration.
- With an 70841 pattern generator module with a non- 70311 clock source module.
- With non- MMS70841 pattern generator and clock source modules.

Load the Eye-Diagram Personality

Each time the 71501D is turned on, the 70874A eye-diagram analyzer personality (part number 70874-10001) must be loaded into memory. This occurs automatically if the 70874A memory card is inserted in the front-panel card slot before the instrument is turned on. You can also load the personality in a manual mode.

Complete the Installation Using Self-Guided Screens

Installing the eye-diagram analyzer is easy due to a series of self-guided screens. Depending on the factory configuration of your system, one or more of these screens may not be displayed.

After connecting the equipment and loading the program, you'll need to respond to a series of screens from which to select the following:

- The pattern generator used.
 - The source of the 10 MHz frequency reference.
-

Note When used with an 71612A/70843, the system requires a manual configuration.

Set Up the Measurement Conditions

Select from eye, eyeline, and pattern modes

Use the Setup menu's diagram softkey to select from one of three measurement modes: eye, eyeline, and pattern.

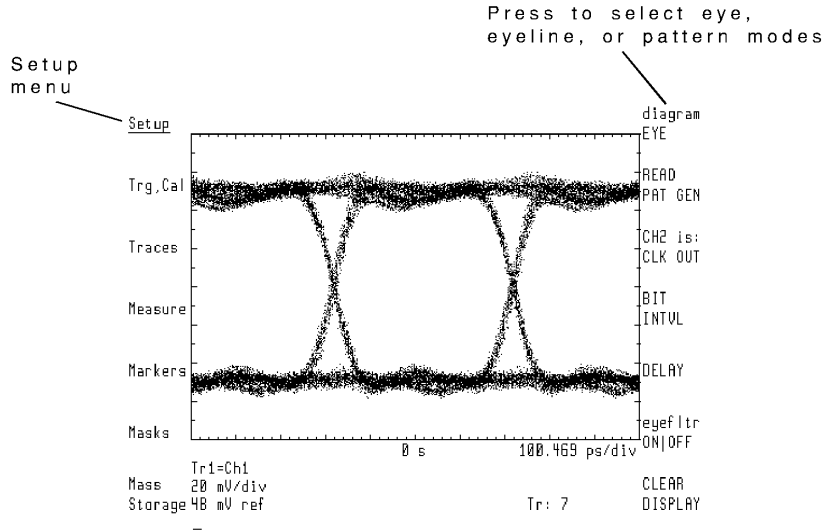

Features Available in Each Mode

	Eye Mode	Eyeline Mode	Pattern Mode
Eye Measurements	X		
Extinction Ratio Measurements	X	X	
Mask Testing	X	X	X
Display the Mask Error Trace		X	X
Improve Sensitivity Using Eye Filtering		X	X
40 GHz Extended Bandwidth		X	X
User-Corrections		X	X
Display Data Pattern			X

Steps for Setting Up Eye-Diagram Analysis

Eye Mode

The eye mode displays traces using individual dots in a manner that is similar to conventional sampling oscilloscopes. Use this mode for the following:

- Typical eye-diagram measurements
- Extinction ratio measurements

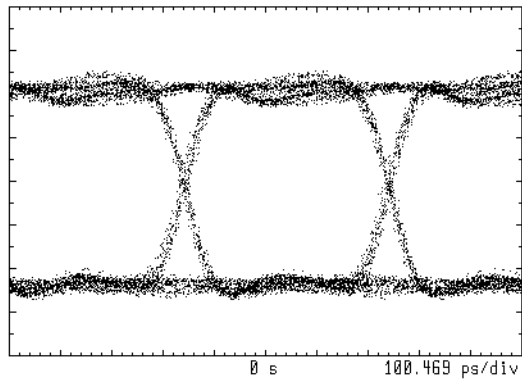

Tr1=Ch1
80 mV/div
240 mV ref

Eyeline Mode

: Eyeline mode displays continuous traces. Use this mode for the following:

- Measure extinction ratio
- Measure laser turn-on transition delay
- Examine laser overshoot
- Observe laser ringing
- Apply eye-filter
- Apply user-corrections

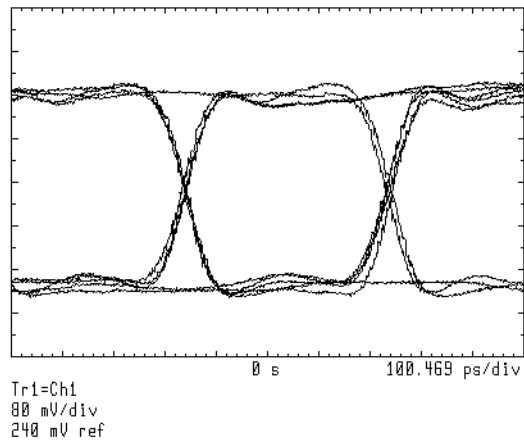

Pattern Mode

Pattern mode displays the actual PRBS data stream bits. This mode uses the pattern trigger which allows the display to show the same portion of the data stream from sweep to sweep.

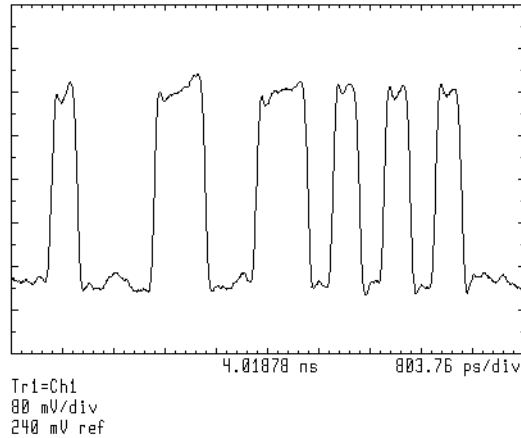
***Mask/limit lines provide pass/fail testing***

Mask/limit lines are displayed geometric shapes that define the acceptable limits and shape of an eye-diagram. The following figure shows a mask. Use masks for pass/fail testing and as an aid to error analysis. The eye-diagram analyzer can capture and display the portion of the pattern that caused a mask violation. Built-in standard masks for the major SONET/SDH transmission rates are provided and can be applied with the press of a softkey. Or, you can create your own custom masks.

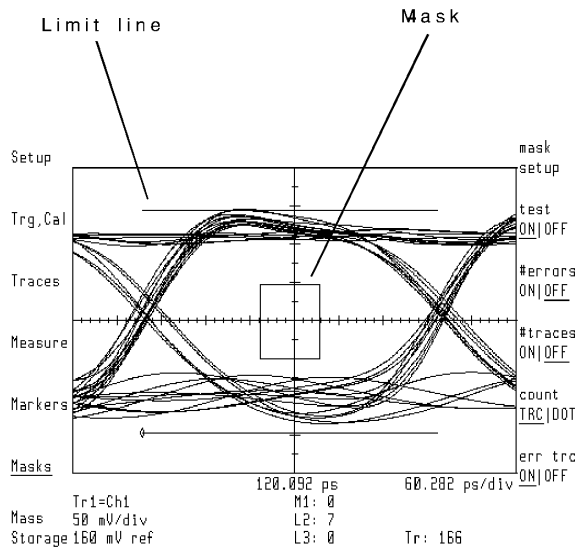

Apply software filters in eyeline mode

In eyeline mode, user frequency corrections can be applied to the data to simulate a hardware transmission filter. The eye-diagram analyzer comes with several Bessel-Thomson filters. These files are on the 71501D memory card. Refer to [Chapter 9, “Agilent 70820A: User Corrections”](#) and [Chapter 11, “Agilent 70820A: Memory Cards, Disks, and RAM”](#) for information on user-corrections.

User Correction Files

File Name	File Data
a_bt_248832	4th order Bessel-Thomson filter for 2.48832 Gbit/sec transmission
a_bt_62208	4th order Bessel- Thomson filter for 622.08 Mbit/sec transmission
a_bt_15552	4th order Bessel- Thomson filter for 155.52 Mbit/sec transmission

Three sweep selections are available

- single
- continuous
- stopped

With the continuous selection, sweeps occur as soon as the selected triggering conditions are met and repeat continuously as long as the trigger conditions are met.

The source of the trigger reference is selected using the Setup menu's CH2 softkey. The following table shows the reference used when using an Agilent 7084X pattern generator.

Table 1-1.

	Trigger Reference of 70841
Eye Mode	CLOCK ^a or TRIGGER
	CLOCK or TRIGGER
	TRIGGER

a. This connection provides faster trace updates.

Entering the pattern generator's settings

The Setup menu's READ PAT GEN softkey queries the 70841 pattern generator and 70311A signal generator for the clock frequency, pattern length, and any divide ratios. In the case of alternate configurations, an appropriate sub-menu will be displayed for the parameters that require manual updating.

Note

A READ PAT GEN should be performed after changing pattern generator settings, such as clock frequency or pattern length.

Moving the measurement plane

Specifying an attenuation on channel 1 changes the measurement plane from the front-panel RF INPUT 1 connector to include the indicated attenuation. Specifying any attenuation on channel 2 may be necessary to ensure proper triggering. Use the Trg,Cal menu's CH1 EXT ATTEN and CH2 EXT ATTEN softkeys to specify any external attenuation.

These softkeys can also be used to specify an optical-to-electrical responsivity conversion between the source and input channels. As a result, the display shows optical units referenced to the input of the optical-to-electrical converter. Channel and marker readouts change to watts/div. Also, the CH1 EXT ATTEN softkey changes to read CH1 RSPVTY (responsivity).

Autoranging

The Trg,Cal menu's autorng ON OFF softkey turns on or off autoranging. When autoranging is activated, the eye-diagram analyzer automatically selects the appropriate hardware gain and offset to maximize the signal at the analog-to-digital converter, regardless of the input signal's amplitude.

Selecting the 10 MHz reference on Instrument Preset

Use the Trg,Cal menu's IP REF softkey to select the source of the 10 MHz reference on an INSTR PRESET. Choices are internal, external, or auto. With auto, the eye-diagram automatically selects an external reference if it is present at the 70820A's rear-panel connector. Otherwise, the module's internal reference is selected.

Redefining the INSTR PRESET key

The Trg,Cal menu's DEFINE USER IP softkey redefines the settings invoked by the INSTR PRESET key. Redefining the instrument preset can save valuable time when configuring for measurements.

Step 1. Connect the Equipment

70841A/B Pattern Generator and 70311A Signal Generator Modules

- 1 If you are using 70841A/B pattern generator and 70311A signal generator modules with your eye-diagram analyzer, install them into an MMS mainframe as shown in the following figure.

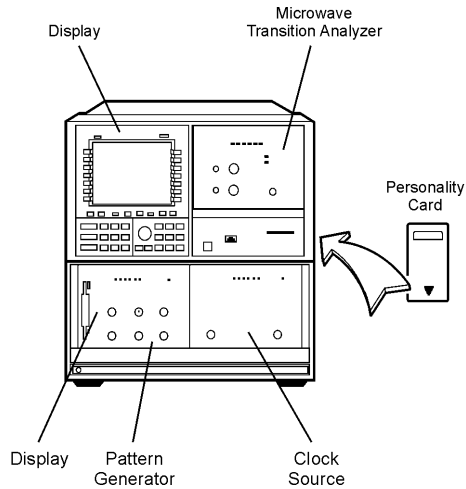

pcb1a

Steps for Setting Up Eye-Diagram Analysis

- 2** If you are using 70841A/B pattern generator and 70311A signal generator modules with your eye-diagram analyzer, connect cables to the instruments as shown in the following graphic.
- If you are using a clock source other than an 70311A, make sure that the signal generator and 70820A microwave transition analyzer module share the same frequency reference. Use the 10 MHz REF connectors on the rear panel of the 70820A.

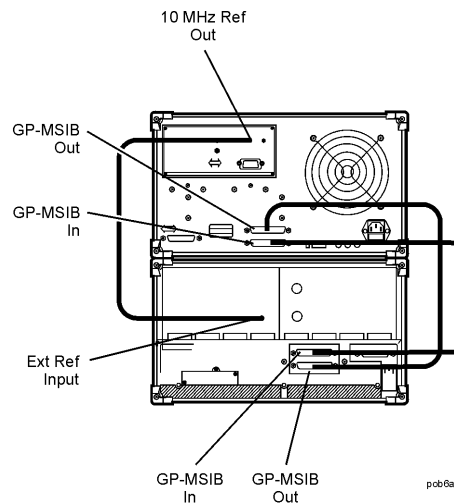

Rear-Panel Cable Connections

- 3** Connect the front-panel cables as shown in the figure on the following page. Use an adapter between the cables and channel connectors. The data signal connects to the 70820A's RF INPUT 1 connector. The trigger or clock signal connects to the 70820A's RF INPUT 2 connector.

Steps for Setting Up Eye-Diagram Analysis

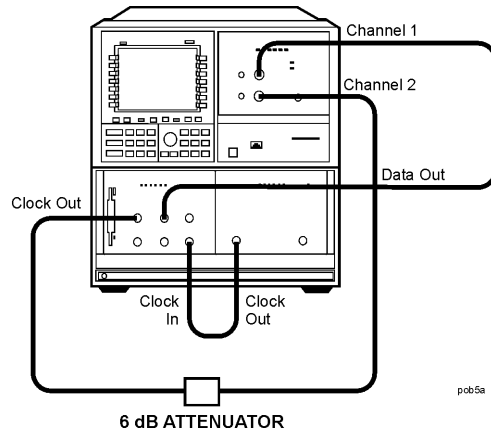

Front-Panel Cable Connections

Cables:

SMA to SMA (Channel 1)	p/n 8120-4948
SMA to SMA (Channel 2)	p/n 8120-4948
SMB to SMB (10 MHz Reference)	p/n 8120-5025

Miscellaneous:

3.5 mm (f) to 2.4 mm (f) (two)	p/n 1250-2277
6 dB attenuator	8493C

- 4 If the attenuator connected to the 70820A's RF INPUT 2 connector is not 6 dB, press:

Trg, Cal, CH2 EXT ATTEN, then enter the value of the attenuator

Laser and Optical-to-Electrical Converter

If you have access to a laser and an optical-to-electrical converter, use the connections shown in the following figure. To protect the input connectors, use adapters between the cables and the connectors. The laser is the device being tested.

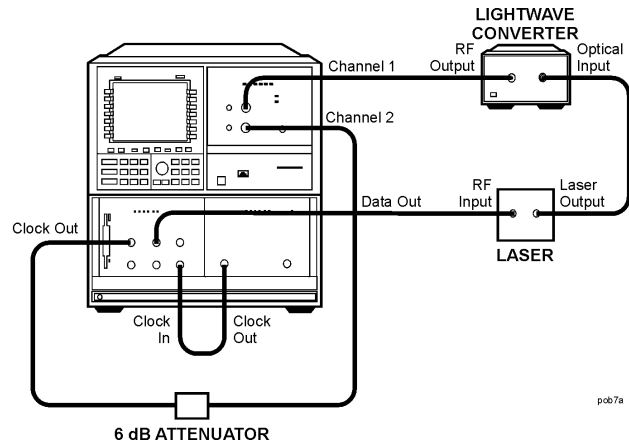

Cables:

SMA to SMA (Channel 1)	p/n 8120-4948
SMA to SMA (Channel 2)	p/n 8120-4948
SMB to SMB (10 MHz Reference)	p/n 8120-5025

Miscellaneous:

3.5 mm (f) to 2.4 mm (f) (two)	p/n 1250-2277
6 dB attenuator	8493C

Steps for Setting Up Eye-Diagram Analysis

Connections without a Laser Source and Converter

If a laser source and optical-to-electrical converter are not available, use the alternate connection shown in the following figure. In this case, the pattern generator's data output is displayed. An electrical device could be inserted between the pattern generator and the eye-diagram analyzer.

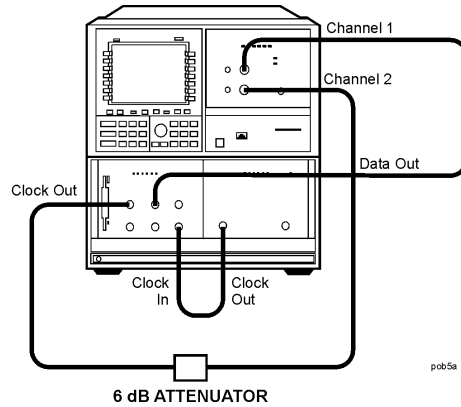

Step 2. Load the Personality

Automatically Load the Personality

- 1 Insert the eye-diagram personality card into the front-panel card slot of the microwave transition analyzer, facing the metal strip on the card downward and toward the instrument. Make sure the card is fully inserted into the card slot.
- 2 Switch on the power to all of the equipment. Switch on the power to the 70820A last. The start up process takes about 6 minutes.

Note

Do not press any instrument keys until the program is loaded. Pressing keys can cause the automatic program loading to abort.

If the Program Failed to Load

The program has failed to load if one of the following occurs:

- The message `Please wait... Loading 70874` never shows.
- The left-side softkeys match those shown in the following figure.

[“Manually Load the Personality” on page 1-17](#)

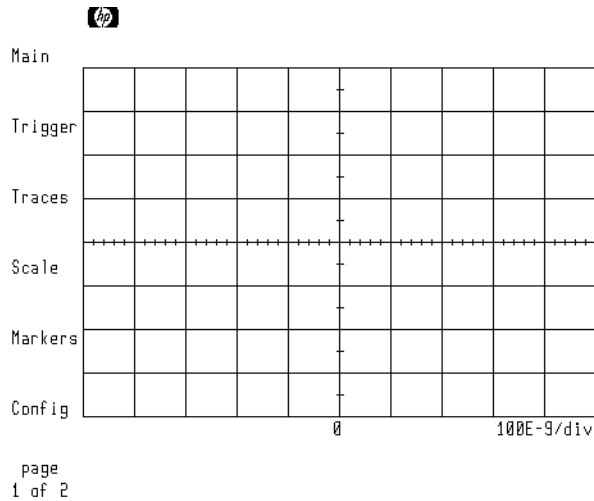

70820A Module's Main Menu

Manually Load the Personality

- 1** Insert the 70874A eye-diagram memory card into the front-panel card slot.
- 2** Display a listing of the files on the memory card by pressing:
MENU, page 1 of 2, States, more 1 of 2, mass storage

Steps for Setting Up Eye-Diagram Analysis

Puls gen																			msi: HP-MSIB
Measure																			PREV PAGE
Table																			NEXT PAGE
Analyze	Prefix:																		LOAD FILE
Calib	MSI: HP-MSIB,4																		save
States	AUTOST	ASCII	1280																more
	a_bt_248032	ASCII	1536																prev
	a_bt_62208	ASCII	1536																menu
	a_bt_15552	ASCII	1536																
	HP70874	ASCII	1120																
	(end of catalog)																		
page	2 of 2																		

- 3 If the screen does not resemble the above figure, press:

msi; *HP-MSIB CARD*, *prev menu*

DISPLAY, *Mass Storage*, *msi*, *MEMORY CARD*

MENU

The list of files should now be displayed.

- 4 Turn the front-panel knob to highlight the file "AUTOST" and then press:

LOAD FILE

If you load the "70874" file by mistake, the message *7386 memory overflow* may be displayed. This error message is a result of the manual loading process and, in this instance, does not indicate a problem. The program still should be properly loaded.

Step 3. Complete the Installation Using the Screen Instructions

- If the displayed screen looks like the figure on the left side of this page, your system has been previously configured. Press CONT and then continue with "Step 4. Connect the front-panel cables". However, if you wish to reconfigure your system, press RECNFIG, and continue with the following explanation of the self-guided screens.
- If the screen looks like the figure on the right side of this page, the first self-guided screen is displayed. Perform the following steps:
 - 1 Press 7084X if you are using an 70841A/B pattern generator. If using an 70843A, or any other pattern generator, press MANUAL.
 - 2 If you press 7084X, the screen shown on the following page is displayed. The program automatically determines and displays the pattern generator module's HP-MSIB address. For most installations, press CONT. To manually enter the HP-MSIB address, use the displayed softkeys.

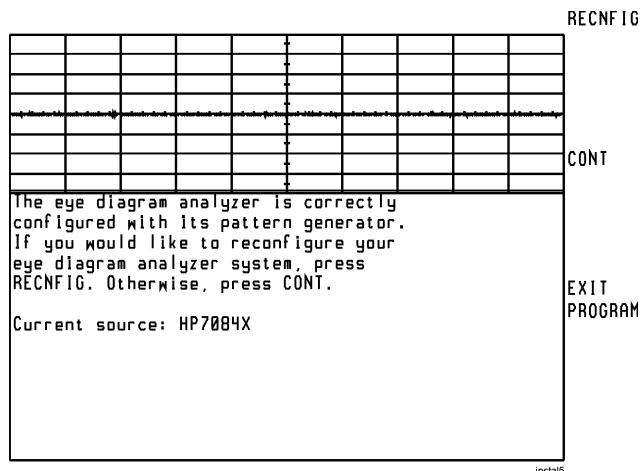

Example of a Configuration Previously Done

Steps for Setting Up Eye-Diagram Analysis

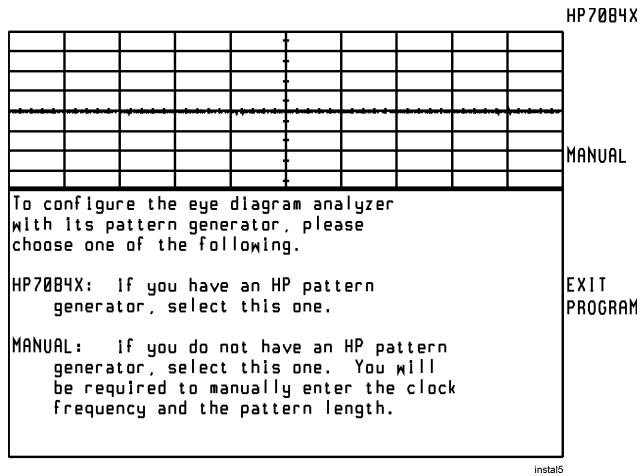

First Self-Guided Screen

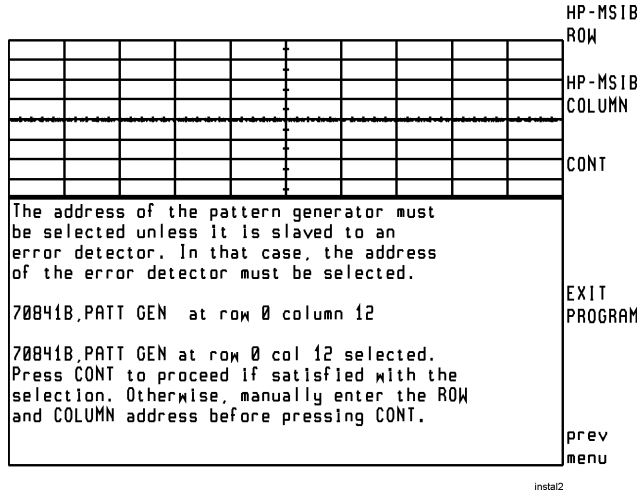

- 3 Use the following self-guided screen to indicate the 10 MHz frequency reference used. Press INTERNL if the 70820A module is used as the reference. Press EXTERNL if the clock source is used as the reference.

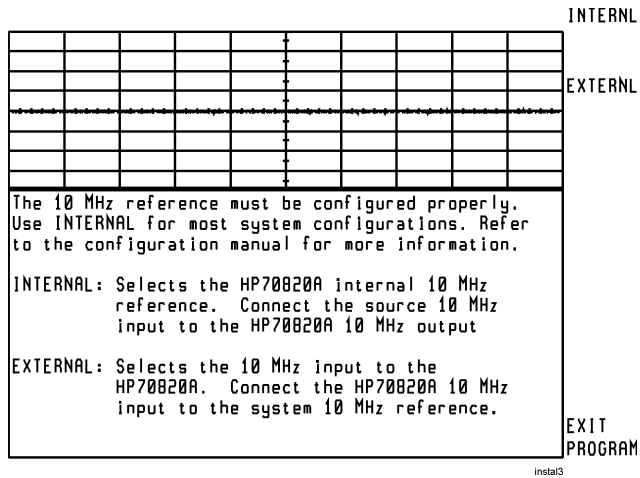

- 4 The following screen should be displayed. Notice that the eye-diagram analyzer's left-side Setup menu is selected.

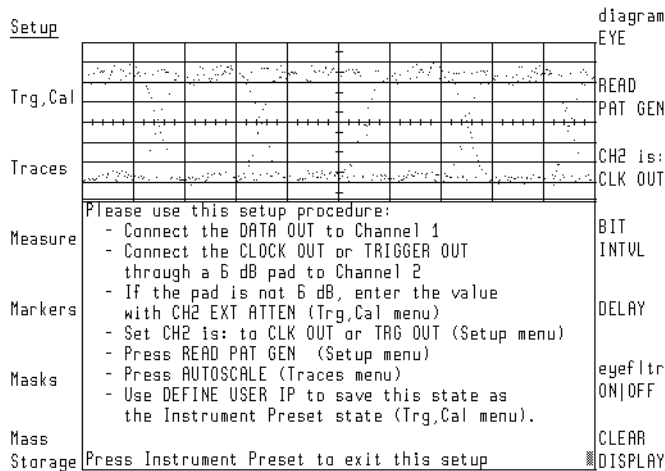

- 5 If you have not already connect the cables to the instruments' front panels, follow the instructions shown. Otherwise, proceed with "If you have not already connect the cables to the instruments' front panels, follow the instructions shown. Otherwise, proceed with "If you have not already connect the cables to

the instruments' front panels, follow the instructions shown. Otherwise, proceed with "If you have not already connect the cables to the instruments' front panels, follow the instructions shown. Otherwise, proceed with "If you have not already connect the cables to the instruments' front panels, follow the instructions shown. Otherwise, proceed with ." on page 1-21." on page 1-21." on page 1-22." on page 1-22.

Step 4. Set Up the Measurement Conditions

Select the Mode

- 1 To select the mode, press:

Setup, diagram, EYE, EYELINE, or PATTERN

Select Single or Continuous Sweeps

- 2 Press the left-side *Trg, Cal* softkey.
- 3 Select one of the following sweep states:
 - Press *SINGLE* to select single sweeps. Each additional press of this softkey triggers another sweep.
 - Press *CONT STOP CONT* to select continuous sweeps.
 - Press *CONT STOP STOP* to stop the sweeps.

Select Trigger Source

- 4 Press the left-side *Setup* softkey.
 - 5 Press *CH2*.
 - If the pattern generator's *CLOCK OUT* signal is connected to the *RF INPUT 2* connector, press *CLK OUT*.
 - If the pattern generator's *TRIGGER OUT* signal is connected to the *RF INPUT 2* connector, press *TRG OUT*.
-

Note

Using the `CLOCK OUT` trigger signal provides faster data acquisition for eye-diagrams. If the amplitude of the trigger signal is too large, an over-range message is displayed. If a message is displayed, reduce the amplitude of the signal; use an external attenuator, and enter the value using `CH2 EXT ATTEN`.

Select the Pattern Generator Settings

- 6** If an 70841A/B pattern generator is used, press `READ PAT GEN`.
- 7** The eye-diagram analyzer reads the settings of the pattern generator.
- 8** If a pattern generator, such as the 70843A/71612A, is used in place of an 70841A/B pattern generator, press:

`READ PAT GEN, CLOCK RATE` and enter the rate of the clock signal

`CLOCK DIVISOR` and enter the divisor for the clock signal

For example, when using a trigger or sync output, enter 16 if the clock signal is divided by 16.

- 9** Enter the pattern repetition length by pressing:

`PATTERN LENGTH` and enter the pattern repetition length

The pattern repetition length is entered in bits or as the binary power depending on the position of the `2n-1 ON OFF` softkey. If the function is on, binary powers are entered in the form 2^n-1 . This makes it very easy to set the pattern length for PRBS sequences. When the function is off, the pattern length is entered directly in bits.

- 10** Press `PAT TRG FACTOR`, and enter the factor that relates how many repetitions of the pattern occur between trigger pulses.

Frequently, 16 to 32 or more repetitions of the pattern occur between trigger pulses.

Note

When operating off a trigger or sync output with a divided clock frequency or a pattern trigger, be sure to set CH2 is: to TRG OUT.

- 11** If a signal generator other than the 70311A is used, enter the precise clock frequency by pressing:

`prev menu, CLOCK RATE` and enter the clock rate

Controlling an 70841A/B Pattern Generator

When using the 70311A clock source (below 3 Gb/s):

This section explains how to display the menus for the 70841A/B pattern generator. The display can be assigned to control either the eye-diagram analyzer or the 70841A/B pattern generator.

Note

If the eye-diagram analyzer is configured with a non 70841 pattern generator, you must manually set the trigger level. Refer to [“To Manually Set the Trigger Level” on page 1-25](#) in this chapter.

- 1 Turn on the power for both mainframes. Wait until the start-up routines are completed and the mainframes are ready for key presses.

- 2 Continue by pressing:

DISPLAY, NEXT INSTR

If several instruments are in the system, you may have to press NEXT INSTR several times.

- 3 If the 70841A/B's status screen, shown in the following figure, is not shown, the pattern generator is probably addressed as a slave instead of a master. Perform the following steps:

- a Press the left-side *Address Map* softkey.

```

  T
  select HP 70841B PATTERN GENERATOR (Status) (0,15)
  pattern Data Normal POLARITY
  edlt DATA
  usr-pat Pattern: PRBS 2^7-1 ECL
  Trigger Pattern: 0000000
  dat o/p DATA
  err-add Trigger Mode: CLOCK / 32 AMPLTD
  trg o/p Internal Clock Freq: 2,400,320,000 Hz DATA
  clk o/p HI-LEVEL
  misc Data: 800.0 mV 0.000 V 0.0 dB 0 V DAT O/P
  Clock: 500.0 mV 0.000 V 0.0 dB 0 V DELAY
  Data Output: ON, Delay 0 s. Optimize DATA DAT O/P
  ON OFF
  more
  1 of 2
  patgen
  
```

An Example 70841A/B's Status Screen

- b Use the front-panel knob to scroll the box to the column where the

70841A/B appears.

- c** Press *ADJUST ROW*, and rotate the knob to move the box to the row where the 70841A/B appears.
- d** Press *ASSIGN BOTH*.
- 4** Use the displayed softkey menus to set the pattern generator to the desired settings. For an example, refer to the paragraph "Configure the data signal" in [Chapter 2, "Application Tutorials"](#).
- 5** To return control to the eye-diagram analyzer, press:
DISPLAY, NEXT INSTR
- 6** To return to the eye-diagram analyzer personality menus, press:
USER

To Manually Set the Trigger Level

If a pattern generator other than the 70841A/B is used, you must use the following procedure to manually set the trigger level.

- 1** Select trace two and turn the display on by pressing:
> prev menu, select:, TR2, display ON/OFF ON
- 2** Automatically scale the trigger trace and set the trigger level by pressing:
AUTO-SCALE, Trg, Cal, LEVEL

Use the knob to position the trigger level indicator line so it crosses an edge.

Steps for Setting Up Eye-Diagram Analysis

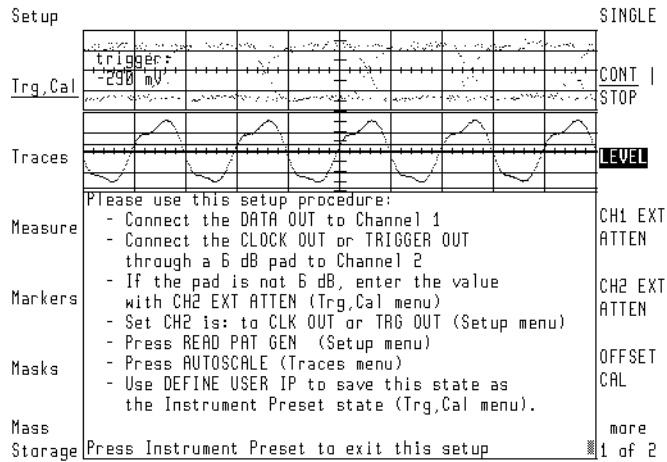

- 3 Turn the display off and select trace one by pressing:

Traces, display ON/OFF OFF, select:, TR1

Move the Measurement Plane

To move the measurement plane, press:

Trg, Cal, CH1 EXT ATTEN and enter the attenuation on channel 1 input.

Optional Step. Save Instrument State as Preset State

- 1 Select the Traces menu and scale the screen to the displayed signal by pressing:

Traces, AUTOSCALE

- 2 Save the current instrument state by pressing:

Trg, Cal, more 1 of 2, DEFINE USER IP, CONT

The current instrument state is saved, including the pattern generator's HP-MSIB address, the frequency reference, scaling, and trigger level. Whenever INSTR PRESET is pressed, the eye-diagram analyzer is automatically placed in these settings.

3 The eye-diagram is now ready for use.

**To restore the
factory
instrument preset**

Restore the factory instrument preset by pressing:

MENU, *page 1 of 2, States, more 1 of 2, preset: FAC|USR FAC*

Getting Started

Steps for Setting Up Eye-Diagram Analysis



Application Tutorials

Application Tutorials

This chapter contains nine tutorials that introduce important eye-diagram analyzer features. The tutorials should be performed in the order listed. To create the data signal, you will need a pseudo-random binary sequence (PRBS) pattern generator. Refer to [“Configure the Data Signal” on page 2-2](#) before you start the tutorials. You will find the following topics in this chapter:

- [Tutorial 1: Measure Eye-Parameters 2-4](#)
- [Tutorial 2: Measure in Optical Power Units 2-8](#)
- [Tutorial 3: Measure Extinction Ratios on Low-Level Signals 2-10](#)
- [Tutorial 4: Measure Laser Turn-on Delay 2-13](#)
- [Tutorial 5: Use Software Filters 2-15](#)
- [Tutorial 6: Test to Industry Standards 2-19](#)
- [Tutorial 7: Default and Custom Mask or Limit Line Testing 2-23](#)
- [Tutorial 8: Display the Data Pattern 2-27](#)
- [Tutorial 9: Constructing a Low-Pass Filter from a Transfer Function 2-30](#)
- [Tutorial 10: Create a Vertical Histogram 2-36](#)
- [Tutorial 11: Create a Horizontal Histogram 2-41](#)

Configure the Data Signal

The following list shows typical settings that can be used for the data signal. The list assumes you are using an 70841A/B pattern generator. The exact settings depend upon the system you are using. If the system includes an 70841A/B pattern generator, use the pattern generator’s status screen to enter these values. The procedure for viewing the status screen is explained in [“Controlling an 70841A/B Pattern Generator” on page 1-24](#).

- In the select pattern menu:
Pattern: PRBS 2⁷-1
 - In the dat o/p err-add menu:
Data Ampl: typically 800 mV to 2 V (depending on laser)
Data Hi-Lvl: 0 V (depending on laser)
 - In the trg o/p clk o/p menu:
-

Clock Freq: 2.48832 GHz

Clock Ampl: 500 mV

Clock Hi-Lvl: 0 V

If you're performing these tutorials without the laser source and optical-to-electrical converter, reduce the level of the data signal as shown in the following settings:

- Data Ampl 250 mV
- Data Hi-Lvl 300 mV

Tutorial 1: Measure Eye-Parameters

The eye-diagram analyzer performs automatic eye measurements in eye mode. This mode is similar to that of conventional sampling oscilloscopes; the display shows individual dots.

View the Signal

- 1 To view the signal, press:

INSTR PRESET, *Traces, persist*, **VARIABLE**

This turns the persistence mode on. Refer to [Chapter 3, “Eye-Diagram Analyzer Reference”](#) for an explanation of the available persistence modes.

- 2 Enter the number of sweeps by pressing:

PERSIST SWEEPS and enter 8

- 3 Turn autoscaling on by pressing:

prev menu, AUTO-SCALE

The display should look similar to the display of a sampling oscilloscope. See the following figure.

The large overshoot shown is a result of the particular laser bias setting used. If the edges of the waveform are unstable in time (indicating no trigger), refer to the [“To Manually Set the Trigger Level”](#) on page 1-25.

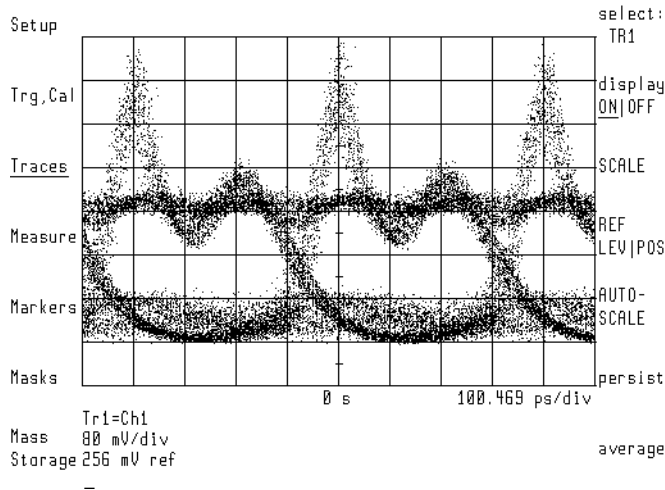

Example of a Large Overshoot Resulting from Laser Bias

Perform an Offset Calibration

This calibration procedure removes any offset that may be present in the optical-to-electrical converter. This is sometimes referred to as the "dark" level. The offset calibration ensures accurate measurements of the laser's one and zero levels.

- 4 Turn the laser off. (If you are measuring the pattern generator directly, disconnect the input signal at channel 1.)
- 5 Perform the calibration by pressing:

Trg, Cal, OFFSET CAL, CONT

The calibration takes about a minute to execute. When the calibration is finished, DC NULL: done is displayed.

- 6 Turn the laser on. (If you are measuring the pattern generator directly, reconnect the input signal at channel 1.)

Measure Signal Parameters

- 7 To include the rise time and fall time measurement in the displayed results, press:

Measure, r/f tim ON OFF ON

Tutorial 1: Measure Eye-Parameters

Enabling this function approximately doubles the measurement time.

- 8 Perform the eye measurement by pressing:

MEASURE EYE

After a brief period of time, the display should look like the following figure. Refer to [Chapter 3, “Eye-Diagram Analyzer Reference”](#) for definitions of each measurement listed on the screen.

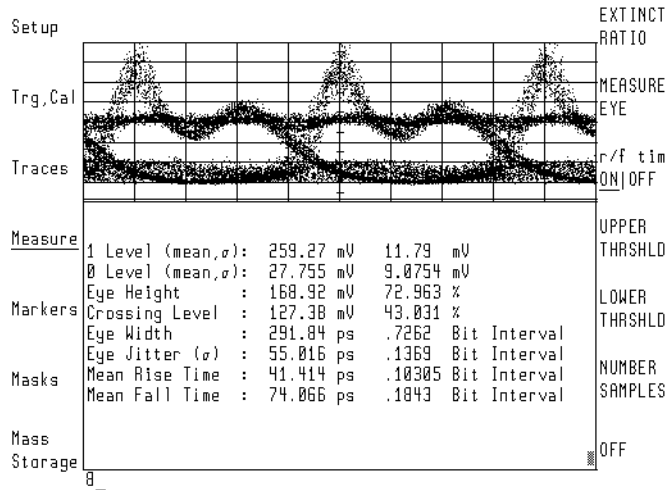

Example Eye Measurements

Measure Extinction Ratio

- 9 Measure the extinction ratio by pressing:

EXTINCT RATIO

The results are added to the displayed list of measurement results.

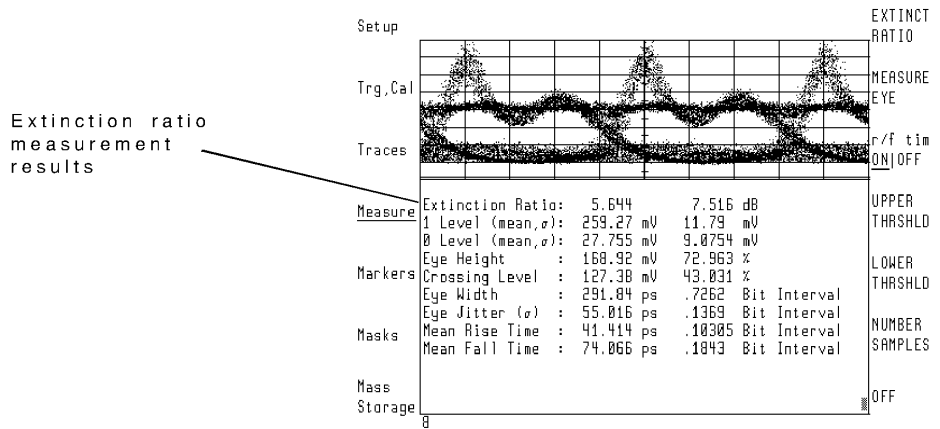

Example Extinction Ratio Measurement

- 10** Change the amount of data used for the histograms by pressing:

NUMBER SAMPLES and enter the # of samples

A larger value gives more accuracy, but increases the data acquisition time.

When making extinction ratio measurements in eyeline mode, the number of samples should be increased from the default of 1000 to something on the order of 20000 to insure a number of traces are evaluated to compute the extinction ratio.

- 11** Clear the measured data from the screen by pressing:

OFF

Tutorial 2: Measure in Optical Power Units

The analyzer display has the ability to show optical units referenced to the input of the optical-to-electrical converter. This changes the channel and marker readouts to watts/div.

- 1 Set the analyzer to a known state by pressing:

INSTR PRESET, Trg, Cal, CH1 EXT ATTEN responsivity value, **V/Watt**

For example, the following figure shows 350 V/Watt entered. Notice the soft-key label changes to CH1 RSPVTY (responsivity).

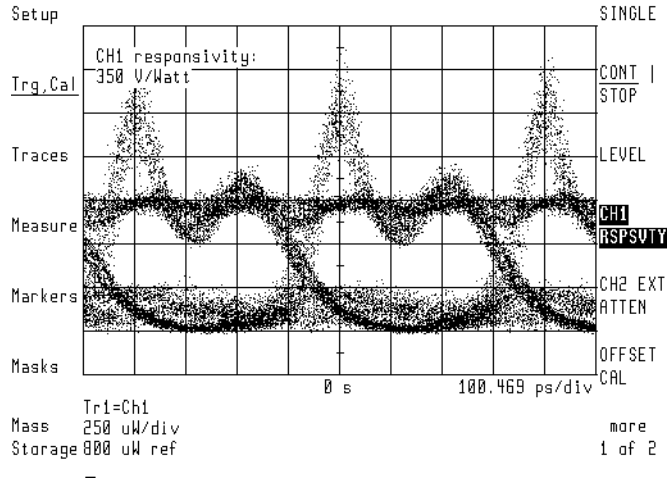

- 2 To use the markers to read optical power, press:

Markers, Y1 (--)

- 3 Adjust the marker line to the peak of the response. For example, the following figure shows a peak optical power of 1.5 mW.

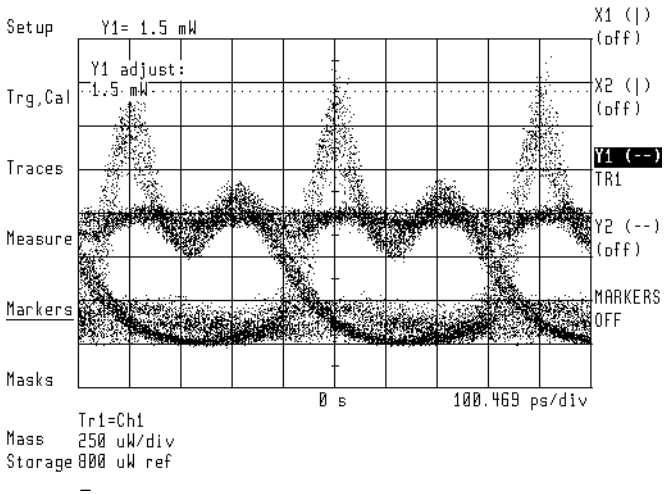

Tutorial 3: Measure Extinction Ratios on Low-Level Signals

Repeatable extinction ratio measurements can be made on low-level signals. This is accomplished by applying a filter to the signal. This filter improves measurement sensitivity and is useful for analyzing:

- low-level extinction ratios
- pattern dependent transitions
- intersymbol interference

In this tutorial, the eye-diagram analyzer is placed in eyeline mode so that the eye filter can be applied to reduce trace noise. To measure the signal, a photodiode converter with a responsivity of 30 volts/watt is used.

When making extinction ratio measurements in eyeline mode, the number of samples should be increased from the default of 1000 to something on the order of 20000. This insures a number of traces are evaluated to compute the extinction ratio. The compatible mode is eyeline.

Change to Eyeline Mode

- 1** Set the instrument to a known state by pressing:

INSTR PRESET, *Setup, diagram, EYELINE, Traces*

- 2** Set the number of persistence sweeps by pressing:

persist, VARIABL, PERSIST SWEEPS and enter **5**, *prev menu*

- 3** Turn on autoscaling by pressing:

Trg, Cal, more 1 of 2, Traces, AUTO-SCALE

The display should look like the following figure.

A low-amplitude response, similar to that shown in this figure, can result when using non-amplified lightwave converters to measure optical signals.

Tutorial 3: Measure Extinction Ratios on Low-Level Signals

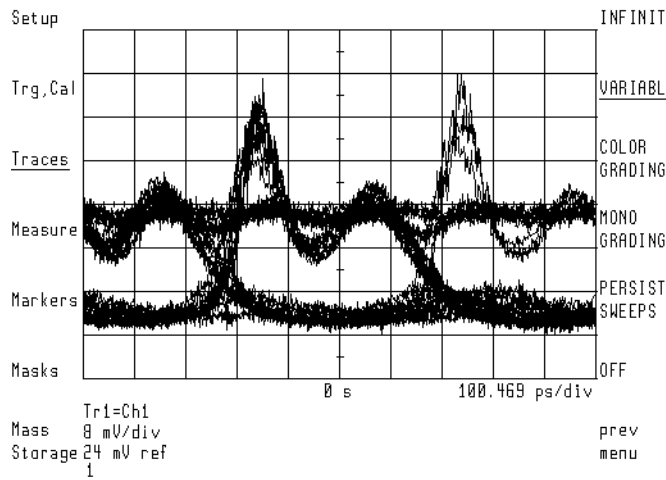
**Autoscaled Display of Low-Level Signal**

- 4 Turn filtering on by pressing:

*Setup, eyefltr ON OFF*ON

Perform an Offset Calibration

This calibration procedure removes any offset that may be present in the optical-to-electrical converter. This is sometimes referred to as the "dark" level. The offset calibration ensures accurate measurements of the laser's level.

- 5 Turn the laser off. (If you are measuring the pattern generator directly, disconnect the input signal at channel 1.)
- 6 Perform the calibration by pressing:

Trg, Cal, OFFSET CAL, CONT

The calibration takes about a minute to execute. When the calibration is finished, DC NULL: done is displayed.

- 7 Turn the laser on. (If you are measuring the pattern generator directly, reconnect the input signal at channel 1.)

Tutorial 3: Measure Extinction Ratios on Low-Level Signals

Measure the Extinction Ratio

8 To measure the extinction ratio, press:

Measure, *NUMBER SAMPLES* and enter **20000**, *EXTINCT RATIO*

Refer to the following figure.

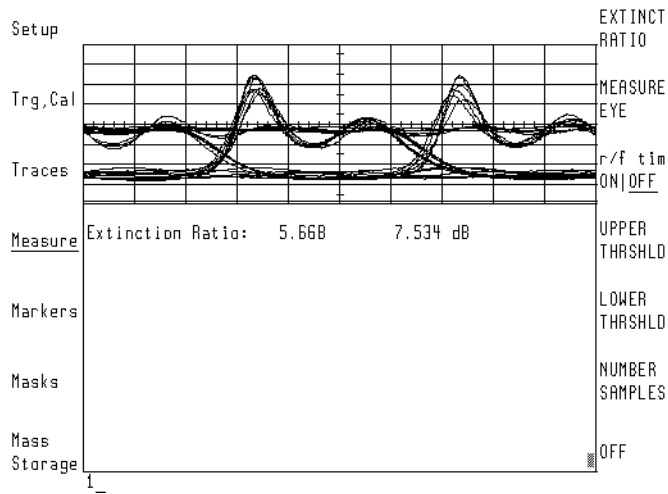

Extinction Ratio Measurement on a Low-Level Signal with Eye Filtering On

Display the Signal in Optical Units

9 To display the signal in optical units, press:

Trg, Cal, *CH1 EXT ATTEN* and enter **30** *V/Watt*

Tutorial 4: Measure Laser Turn-on Delay

On-screen markers can be used to measure both amplitude and time separation in eye-diagrams. The compatible modes for markers are eye, eyeline, and pattern.

Change to Eyeline Mode

- 1 Change to eyeline mode, then turn filtering on by pressing:

INSTR PRESET, *Setup, diagram, EYELINE, eyefltr ON OFF*ON,
BIT INTVL and enter **1**

- 2 Set the persistence to infinite by pressing:

Traces, persist, INFINIT, Trg, Cal

- 3 After several traces have been displayed, press:

*CONT STOP*STOP

Turn on the markers

- 4 Press *X1* and *X2* to activate markers 1 and 2.
- 5 Turn the front-panel knob to move the markers to different transition crossing points on the waveform as show in the following figure.

This provides an easy method to check the peak-to-peak difference in the laser turn-on time measured at the crossing point. Notice in the following figure, a delta reading of 30 ps is displayed at the top of the screen.

Tutorial 4: Measure Laser Turn-on Delay

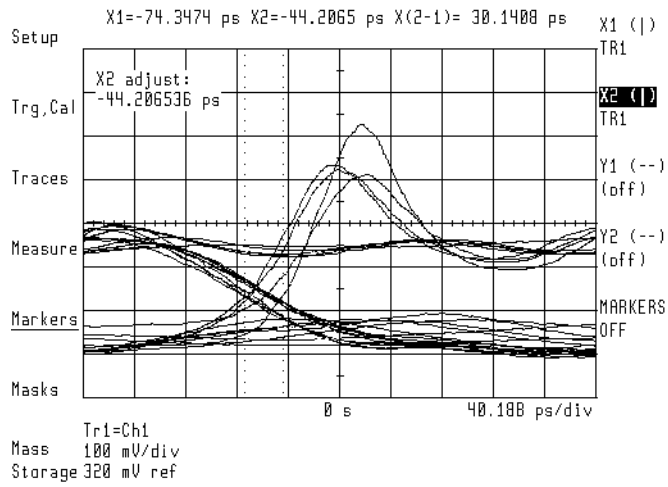

Laser Overshoot and Turn-On Delay

Tutorial 5: Use Software Filters

This tutorial enables a software filter. The filter is designed with user frequency corrections. User frequency corrections can be used for:

- Removing the effects of frequency response roll-off due to the optical-to-electrical converter and cables.
- Simulating hardware filters recommended for laser transmitter evaluation, such as 4th-order Bessel- Thomson filters.

The eye-diagram analyzer must be in eyeline mode to apply user-corrections. In eyeline mode, each sweep produces a continuous trace with the points connected. (This is opposed to unconnected dots with the eye mode.) Eyeline mode is especially useful for measuring variations in laser turn-on delay, overshoot, and ringing and for applying user frequency corrections. The compatible mode is eyeline.

Several Bessel-Thomson software filters are included on the 70874A eye-diagram analyzer's memory card. These filters can be applied as user-corrections in the eyeline and pattern modes. (User corrections must be off in eye mode.) User correction files are identified by the prefix `a_` as shown in the following table. Two additional files on the card, `AUTOST` and `70874`, comprise the eye-diagram analyzer program.

Supplied User-Correction Files

File Name	File Data
<code>a_bt248832</code>	4th order Bessel- Thomson filter for 2.48832 Gbit/sec transmission.
<code>a_bt_62208</code>	4th order Bessel- Thomson filter for 622.08 Mbit/sec transmission.
<code>a_bt_15552</code>	4th order Bessel- Thomson filter for 155.52 Mbit/sec transmission.

Tutorial 5: Use Software Filters

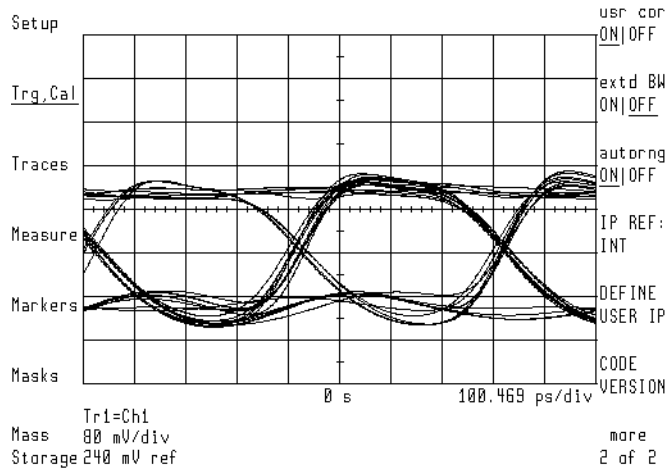

User-Corrections Applied to the Data

Change to Eyeline Mode

- 1 Set the analyzer to a known state by pressing:

INSTR PRESET, *Traces, persist, VARIABLE* and enter **5**, *diagram, EYELINE*

Notice the level of the laser overshoot, and the turn-on delay, varies from sweep to sweep, dependent on the previous pattern of ones and zeros.

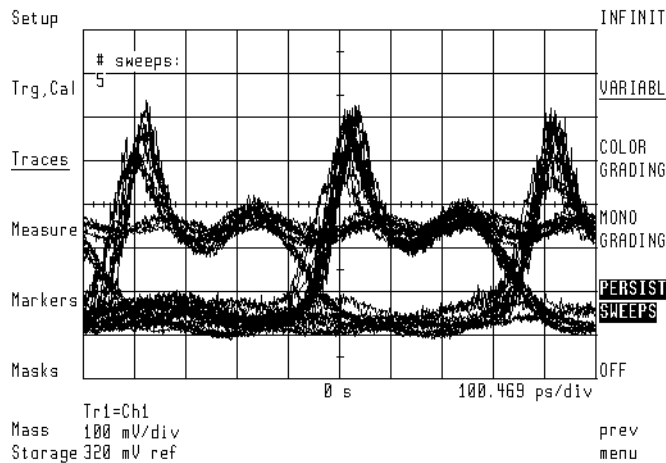

Eyeline Display Showing Laser Overshoot

Load the Software Filter

- 2 Place the 70874A memory card in the front-panel card slot.
- 3 Display the catalog of files on the memory card by pressing:
Mass Storage
- 4 Turn the front-panel knob to highlight the file "a_bt248832".
- 5 Load the file into user-corrections by pressing:

LOAD FILE

This file simulates a 4th-order Bessel-Thomson filter with a cutoff at three-quarters of the bit rate. This allows you to observe the laser transmitter signal in a specified bandwidth. This software filter is equivalent to using a hardware filter, except that trace noise may be suppressed more.

- 6 Apply the filter data to the traces by pressing:

Trg, Cal, more 1 of 2, usr cor ON OFF ON

Tutorial 5: Use Software Filters

7 Turn the autoscale function on by pressing:

Traces, AUTO-SCALE

The display should look like the following figure.

Notice that the laser overshoot is no longer visible, due to the filtering effect of the user-corrections in the 71501A.

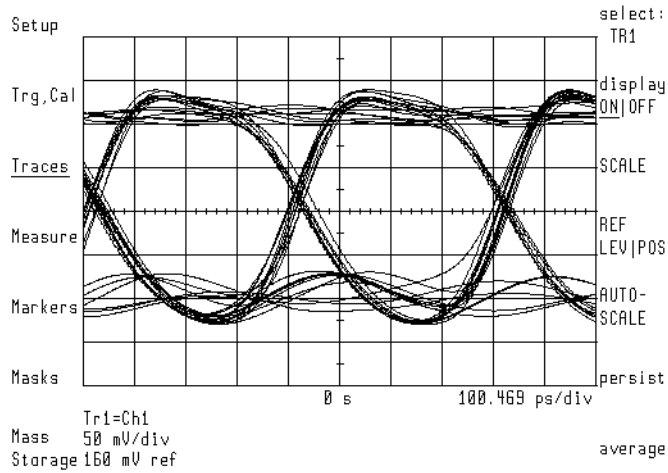

Example Filtered Laser Overshoot

Tutorial 6: Test to Industry Standards

Masks allow you to test eye-diagrams against industry standards. The eye-diagram analyzer provides built-in masks for testing the major SONET/SDH transmission rates. Compatible modes are eye and eyeline. Shown in this tutorial is the ability to:

- Count mask errors
- Allow for specified amount of margin testing
- Stop after a specified number of trace errors
- Show the violation trace (eyeline mode only)

Select the Mask

- 1 Set the analyzer to a known state by pressing:

INSTR PRESET

- 2 You can use your own hardware filter during this tutorial, or load a software filter as described in the previous tutorial.

- 3 Set the bit interval and delay by pressing:

Setup, BIT INTVL and enter **1.5, DELAY**

Adjust the delay to center the eye.

- 4 Select a mask by pressing:

Masks, mask setup, default masks, STM-16 OC-48

The display shows an unscaled rectangle mask.

- 5 Align the mask by pressing:

MASK ALIGN

Wait for the displayed # samp count to reach 100%.

This step aligns the mask to the data using automatic scaling. Notice that, for the purposes of clarity, the graticule is turned off. This was done using the 70820A Config menu.

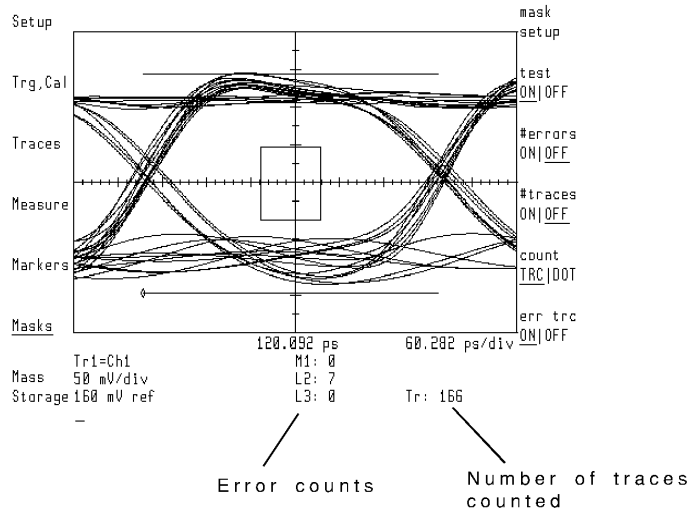
Tutorial 6: Test to Industry Standards**Turn Mask Testing On**

- 6** Turn mask testing on by pressing:

Masks, test ON OFF ON

This resets the error counters. Errors for the standard specifications show up beside the M1 screen annotation for mask violations, and beside L2 and L3 for upper and lower limit violations, respectively.

Notice that in this case, violations are occurring due to too much overshoot.

Test with Additional Margin

- 7** Set a 15% mask margin and turn margin testing on by pressing:

*mask setup, MASK MARGIN and enter **15**, msk mar ON OFF ON*

This displays a second set of mask and limit lines for the 15 percent margin. Errors for the specifications with the specified amount of margin show up beside the M4, L5 and L6 screen annotations.

The eye-diagram analyzer can count dot (trace point) errors instead of trace errors. Use the count TRC DOT softkey to make the selection. If a given error puts 12 trace points within the mask, then the error counter increments by 12. This is useful for determining the extent of any given error. These features can be used with either eye or eyeline modes.

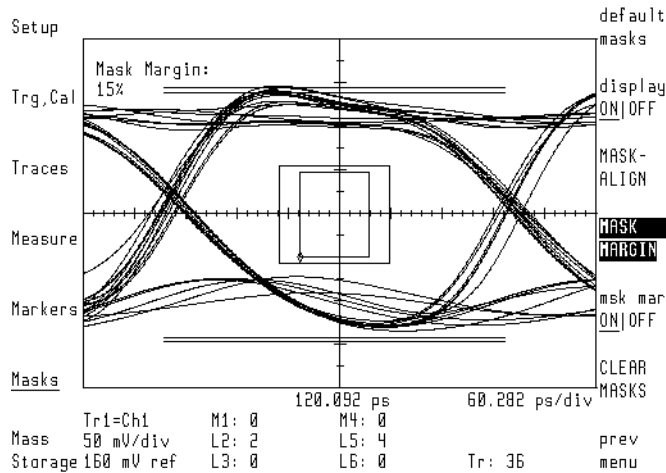

Stop on and Display Trace Errors

The eye-diagram analyzer has the ability to stop data acquisition when a mask violation occurs. The number of traces or errors that stop this data acquisition can be specified. In addition, if you are in eyeline mode, you can separately display the traces that have caused an error.

- 8** Set the bit interval and delay by pressing:

Setup, BIT INTVL and enter **1**, *DELAY* and enter **-3**

The mask will be offset to the right side of the display.

- 9** Set the analyzer so testing will stop after two errors have occurred by pressing:

#Errors ON OFF ON and enter **2**

- 10** If #Traces is set to on, the eye-diagram analyzer stops sweeping when either the error or trace limit is reached. Turn the number of traces function off by pressing:

#Traces ON OFF OFF

- 11** Turn error tracing on by pressing:

err trc ON OFF ON

Any trace which violates the mask shows on the lower-half of the screen.

- 12** Reset and start the trace and error counters by pressing:

Tutorial 6: Test to Industry Standards*test ON OFF ON*

The instrument stops sweeping after two error traces have been accumulated. Refer to the following figure. Note that for this figure, errors occur due to overshoot on a zero-to-one transition.

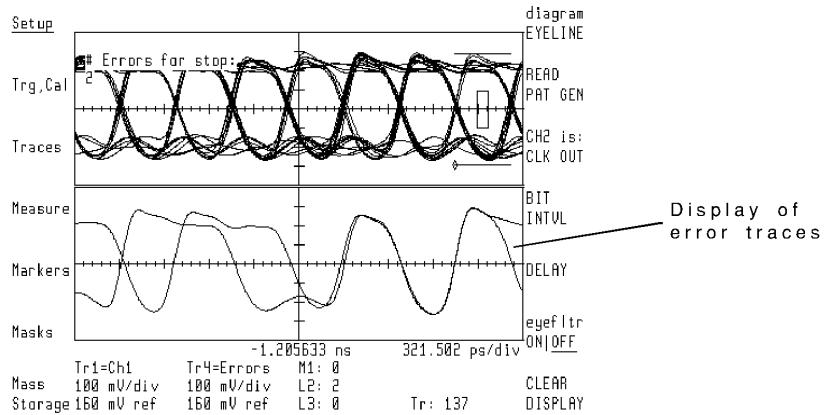
**Turn off Mask Testing**

- 13** Turn off error tracing and the display by pressing:

err trc ON OFF OFF, mask setup, display ON OFF OFF, Trg, Cal, CONT STOP CONT

Tutorial 7: Default and Custom Mask or Limit Line Testing

The 70820A menus allow you to create and display up to eight limit lines and masks at one time. Five default mask/limit-line shapes are provided for your use:

- hexagon
- square
- equilateral triangle
- inverted equilateral triangle
- flat line

You can stretch, shrink, or move any mask. It is also easy to add additional points or delete unneeded points from any shape. Both limit lines and masks can establish either upper or lower limits for a response.

Custom masks are easy to create by editing the supplied default shapes. The compatible modes are eye, eyeline, and pattern.

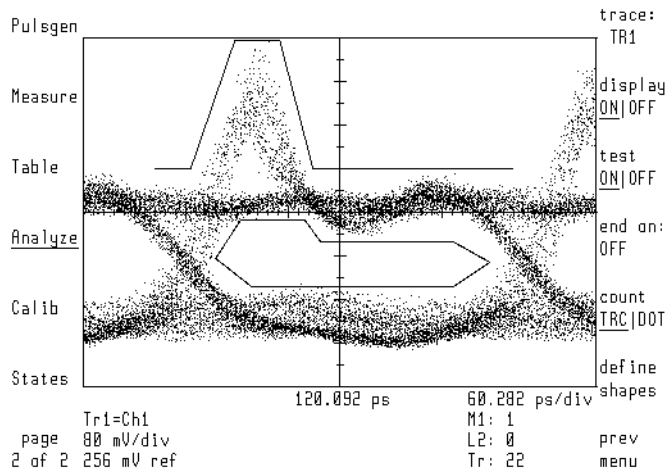

Example of a User-Created Mask

Create a Mask or Limit Line

- 1** Set the analyzer to a known state by pressing:

INSTR PRESET, *Setup, BIT INTVL* and enter **1.5**, *Traces, persist, VARIABLE, PERSIST SWEEPS* and enter **8**

MENU, *page 1 of 2, Analyze, masks, limits, define shapes, type:*

- If you want to create a mask, press *MASK*.
- If you want to create a limit line, press *UPPER LIMIT* or *LOWER LIMIT*.

Select a Default Mask Shape

- 2** Select the shape that most closely matches the mask you need. For example, to display a hexagon, press:

default shapes, hexagon

Edit the Shape

- 3** To edit the shape, press:

edit

Move a Point

- 4** To move a point, select the point to be moved by pressing: \uparrow or \downarrow

- 5** Select the direction to move by pressing: *move X/Y*

Move the point by rotating the front-panel knob or using the numeric keypad.

Add a Point

- 6** To add a point, select the point to be moved by pressing: \uparrow or \downarrow

Note

Select the closest point counterclockwise from the one that you intend to add.

- 7** Add a point at the location of the currently selected point by pressing: *ADD POINT*

A point is inserted between the currently selected point and the next point.

- 8** Select the direction for moving the new point by pressing: *move X/Y*

Rotate the front-panel knob to move the point.

Delete a Point

- 9** To delete a point, select the point to be moved by pressing: \uparrow or \downarrow

- 10** Delete the point by pressing: *DELETE POINT*
-

Stretch, Reduce, or Move the Mask

- 11** To stretch, reduce or move the mask by press:

prev menu, scale X/Y or offset X/Y

Add a Mask Margin

- 12** Press the left-side *Masks* softkey.

- 13** To automatically align the mask to a displayed signal, press:

MASK ALIGN

- 14** To add mask margins, press:

MASK MARGIN and enter the % of needed margin

msk mar ON/OFF ON, prev menu

Begin a Test

- 15** Display the Masks/Limits menu by pressing:

***MENU**, page 1 of 2, Analyze, masks, limits*

- 16** Select the trace for testing by pressing:

trace:

- 17** If trace violations are to be counted as errors, press:

count TRC/DOT TRC

- 18** If measurement point violations are to be counted as errors, press:

count TRC/DOT DOT

- 19** To select when testing should stop, press:

end on:

- 20** If you want testing to stop after a set number of errors, press:

#errors ON/OFF ON desired number of errors

- 21** If you want testing to stop after a set number of traces, press:

#traces ON/OFF ON desired number of traces

- 22** To begin testing, press:

test ON/OFF ON

Display the Error Trace

- 23** Display a mask and begin testing as described in this section, and then press:

err trc ON/OFF ON

Erase a Mask or Limit Line

- 24** Select the mask or limit line you wish to erase by pressing:

MENU, *page 1 of 2, Analyze, masks, limits, define shapes, edit*

SELECT the number of the mask or limit line to be erased

- 25** Erase the mask by pressing:

delete shapes , DELETE CURRENT

Remove all Displayed Masks

- 26** Remove all displayed masks by pressing:

Masks, mask setup

- 27** To temporarily prevent the display of a mask without removing it, press:

display ON/OFF OFF

- 28** To remove the mask, press:

CLEAR MASKS

Refer to [“Applying Mask Testing” on page 3-31](#) to learn more about saving, recalling, and erasing masks.

Tutorial 8: Display the Data Pattern

The eye-diagram analyzer can display the data pattern. This is done by selecting the pattern mode and triggering the display trace update on the pattern trigger. This insures the trace on the screen remains the same from sweep to sweep. In this mode, trace averaging can be used for more repeatable measurements on noisy signals.

Masks and limit lines can be used with the pattern mode and are useful for testing specific portions of the data sequence for mask or template violations. This can uncover violations that happen only when a specific pattern of ones and zeros occur. The compatible mode is Pattern.

Select Pattern Mode

- 1 Press **INSTR PRESET**.
- 2 If you are using an 70841A/B pattern generator, connect the TRIGGER OUT signal to the 70820A module's RF INPUT 2 connector.

This procedure uses the eye-diagram analyzer's pattern mode. In pattern mode, the trigger signal must come from the TRIGGER OUT and not the CLOCK OUT connector. The pattern mode only works with a pattern trigger, and not with a clock signal. The pattern trigger is derived from the clock signal divided by the pattern length.

- 3 Select the pattern mode by pressing:

Setup, diagram, PATTERN

Notice the CH2 is: softkey label has changed to indicate that the trigger source is connected to the TRIGGER OUT signal.

- 4 Select the bit interval and the delay by pressing:

BIT INTVL and enter **20**, *Traces*

- 5 Turn autoscaling on by pressing:

AUTO-SCALE

The display should look like the following figure.

Tutorial 8: Display the Data Pattern

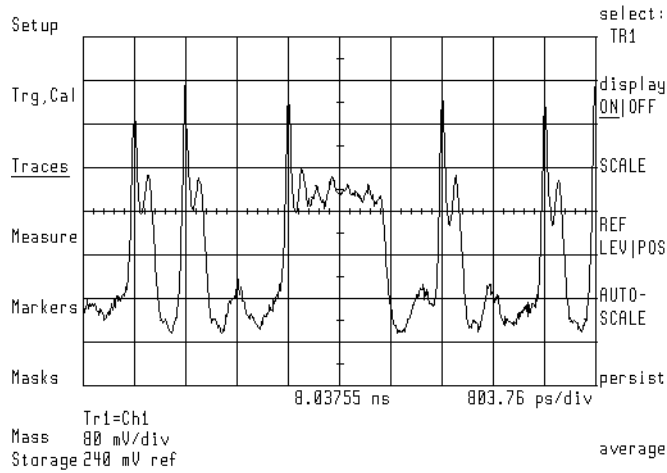

Example Pattern Mode Display

Add Time Delay

- 6** Add time delay by pressing:

Setup, DELAY

Each push of the step keys (\downarrow and \uparrow) gives a change in delay equal to exactly one bit.

This technique can also be used to step the X offset of the mask one bit at a time, to check for mask violations at each bit position.

- 7** Disconnect the RF cable from the pattern generator's TRIGGER OUT connector and connect the cable to the CLOCK OUT connector.

8 Set channel 2 by pressing:

CH2 is; CLK OUT

Notice that the diagram softkey annotation no longer indicates pattern mode, and a note is displayed on the screen as shown in the following figure.

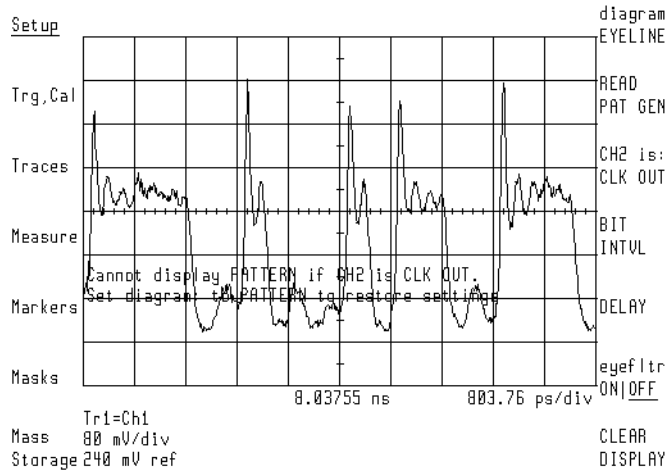

Example Display of User-Error in Pattern Mode

Tutorial 9: Constructing a Low-Pass Filter from a Transfer Function

This procedure builds a fourth order Bessel-Thomson filter characterizing SONET/SDH transmitters operating at 2.48832 Gbit/sec. The filter is loaded into channel 1 user-correction data. The user-correction data is based on the transfer function:

$$H_{(p)} = \frac{105}{(105 + 105y + 45y^2 + 10y^3 + y^4)}$$

where:

$$y = 2.1140p$$

$$p = jw/w_r$$

$$w_r = 1.5\pi f_0$$

$$f_0 = \textit{bit rate}$$

Note

This tutorial of manually constructing a filter is useful as an example. To aid in the construction of 4th order Bessel Thomson filters at other frequencies, use the MAKEFILT program located on the IBASIC UTILITIES FOR 71500 SERIES memory card. This card is supplied with the jitter and eye-diagram analyzer.

Construct the Filter

For this example, $f_0=2.48832$ Gbit/sec.

- 1 To construct the filter, press:

MENU, *Config*, *TRACE POINTS* and Enter 256

more 1 of 3, LINES DOTS LINES

- 2 Set an appropriate frequency range for the filter frequency points by setting the span to $2/f_0$. This is 803.75514 ps for this example. Press:

Main, SEC/DIV, and enter *803.75514 ps*

Tutorial 9: Constructing a Low-Pass Filter from a Transfer Function

- 3 Turn the display off by pressing:

Traces, select, TR1, display ON OFF OFF

- 4 Build the equation by pressing:

select, TR2, input, build eqn, CLR - END, SEL/EDT SEL

- 5 Turn the front-panel to highlight the j operand, and then press:

INSERT

Continue using this technique to construct the trace equation shown in the following figure. Enter numbers using the front-panel numeric keypad.

Main	TR2 = j*2.01056*FREQ/2.40032E9				SEL EDT
Trigger	(IMAG()	CH1	(DELETE
	AC()	INTEG()	CH2)	
	ANALY()	MAGN()	MEM1	[
Traces	ATAN()	REAL()	MEM2	,	-->
	DB()	SIGN()	MEM3]	
	DC()	SQRT()	MEM4	E	
	DEG()	SUM()	TR1	+	
Scale	DFT()	TD()	TR3	-	<--
	DIFF()		TR4	*	
	d/dx()		e	/	
Markers	EXPJ()		j	CHOP	CLREND
	FFT()		n	CONV	
	FM()		PI	CORR	
Config	IDFT()		TIME	MOD	RETURN
	IFFT()	Fsig	FREQ	SHIFT	
		Fcar	POWER	VS	
page					prev
1 of 2					menu

Tutorial 9: Constructing a Low-Pass Filter from a Transfer Function

- 6** Build the trace equation shown in the following figure by pressing:

RETURN, select., TR3, input., build eqn, CLR - END, SEL/EDT SEL

Build the trace equation. Notice the cursor has wrapped to the following line. Be sure to include the last two right parenthesis characters shown on the last line.

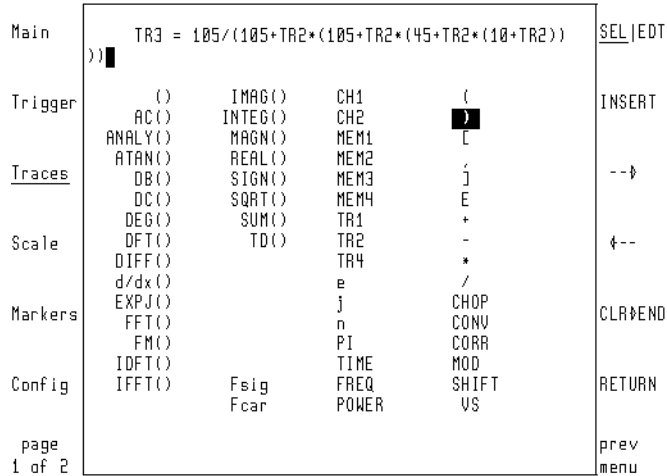

- 7** Turn auto-scaling on by pressing:

RETURN, format., PHASE, Scale, AUTO-SCALE

- 8** Set the marker by pressing:

Markers, M1 ↓

Continue pressing M1 (↓) until TR3 is shown in the M1 (↓) softkey label.

- 9** Repeatedly press M2 (↓) until TR3 is shown in the M2 (↓) softkey label.

Tutorial 9: Constructing a Low-Pass Filter from a Transfer Function

- 10** Set the marker on 1.86224 GHz using the knob or numeric keypad.

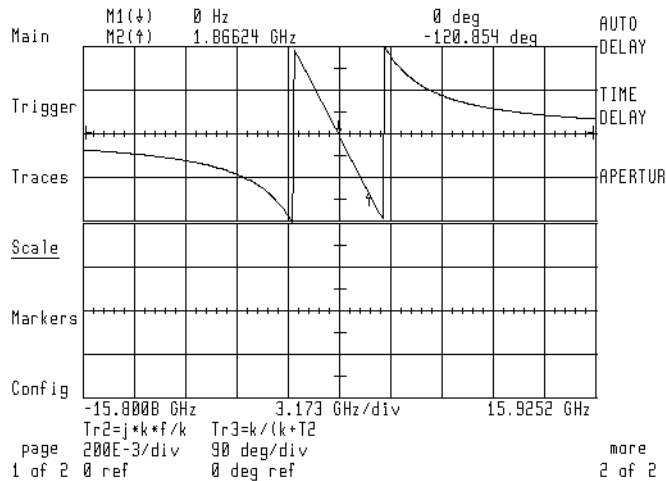

- 11** Continue by pressing:

Scale, more 1 of 2, AUTO DELAY, Traces, store trace, to user correct, adaptiv ON/OFF ON

- 12** Store the filter response in user-corrections by pressing:

CHAN 1 USR COR

- 13** To view the response or to view the data, press:

Traces, select., TR2, display ON/OFF OFF, select., TR3, display ON/OFF OFF, select., TR1, input:

Tutorial 9: Constructing a Low-Pass Filter from a Transfer Function

14 Highlight "UCORR1" using the knob.

Main	TR1 = CH1	CH1
Trigger	1 = CH1 CH2	CH2
Traces	4 = CH1/CH2 CH2/CH1 CH1/MEM1 CH2/MEM2 TABLE	CH1/CH2
Scale	UCORR1 UCORR2 (CH1/CH2)/MEM1 (CH1/CH2)/MEM3	CH2/CH1
Markers	2*MAGN(CH1/CH2)/(MAGN(MEM2)+MAGN(MEM3))	MEMx
Config	2 = j*2.81856*FREQ/2.46832E9 3 = 105/(105+TR2*(105+TR2*(45+TR2*(10+TR2)))	build eqn
page	1 of 2	RETURN

15 Continue by pressing:

RETURN, Scale, AUTO-SCALE, page 1 of 2, Calib, user corr

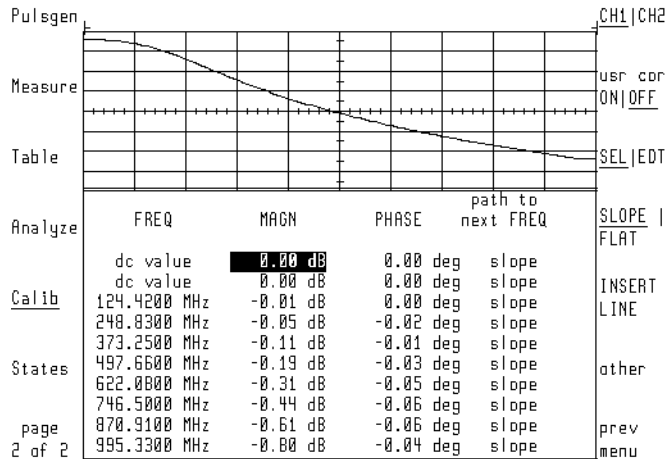

- 16 To store the filter to a memory card, press:
States, more 1 of 2, mass storage
- 17 If the mass-storage device needs to be selected, refer to [“Saving to Mass Storage” on page 3-34](#).
- 18 Save the user-corrections by pressing:
save, SAVE USR COR
- 19 To restore the instrument settings, press:
INSTR PRESET

Tutorial 10: Create a Vertical Histogram

This tutorial creates a vertical histogram on data taken from a sine wave. The procedure, however, works for any type of waveform.

Select the Histogram Type

- 1** Display a trace to perform statistical analysis on.
- 2** Display the histogram menu by pressing:
page 1 of 2, Analyze, histogm
- 3** Select the trace to perform the statistical analysis on by pressing:
trace:

Use the knob to select the desired trace.

- 4** Select the Vertical Histogram function by pressing:
*histog., VERTICL HISTOGM*VERTICL HISTOGM

Acquire the Data

- 5** Define the window for taking histogram data by pressing:
other, WINDOW MARKER1, WINDOW MARKER2

Notice the values of the marker positions are indicated at the top of the display.

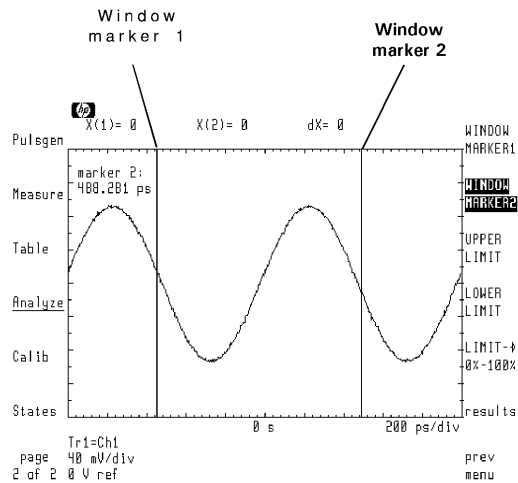

- 6** Enter the number of samples to be taken for the histogram by pressing:

prev menu, NUMBER SAMPLES, # of samples, ENTER

The default number of samples taken is 1000.

- 7** To draw the vertical histogram, press:

SINGLE ACQUIRE

Data will be acquired once.

- 8** To continually acquire and update the histogram, press:

CONT ACQUIRE

Tutorial 10: Create a Vertical Histogram

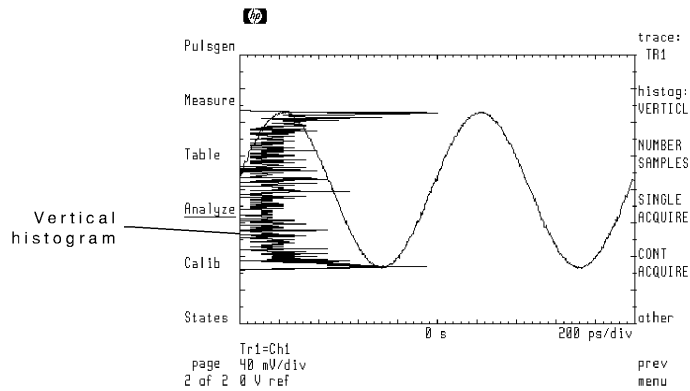

Perform Statistical Analysis

The range of sample points used to calculate the mean and standard deviation is the full screen.

- 9 To change the limits, press:

other, *UPPER LIMIT*, *LIMIT*→ 0%-100%, new upper limit value, *ENTER*,
LOWER LIMIT, *LIMIT*→ 0%-100%, new lower limit value, *ENTER*

Notice the values of the limit-line positions are indicated at the top of the display.

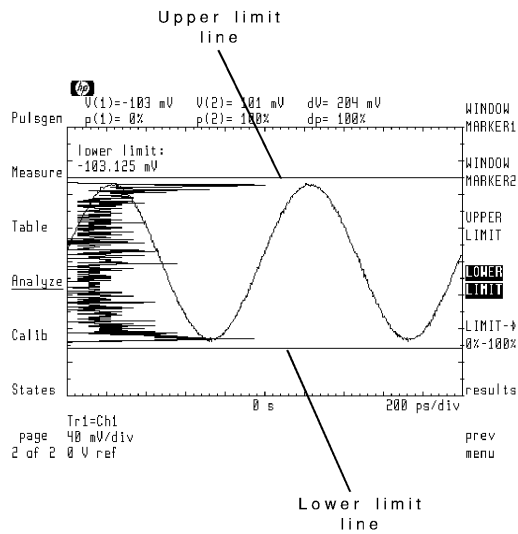

- 10** To display a line indicating the location of the mean, press:
results, MEAN,
The mean and standard deviation values are also shown.

Tutorial 10: Create a Vertical Histogram

- 11** To display a line indicating the location of the standard deviation, press:

STD DEV

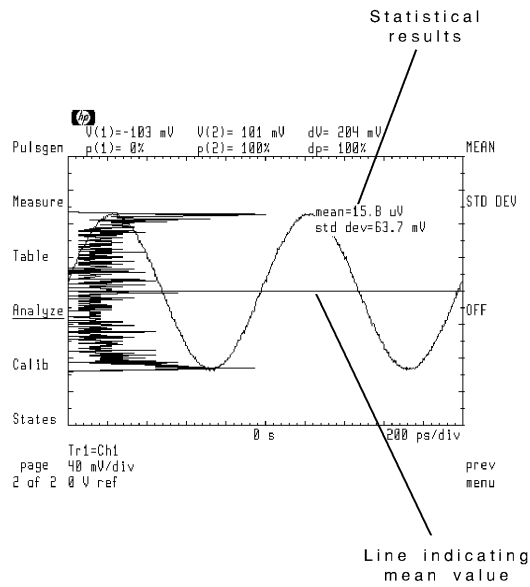

Tutorial 11: Create a Horizontal Histogram

This tutorial creates a horizontal histogram on data taken from a sine wave. The procedure, however, works for any type of waveform.

Select the Histogram Type

- 1 Display a trace to perform statistical analysis on.
- 2 Display the histogram menu by pressing:
page 1 of 2, Analyze, histogm
- 3 Select the trace to perform the statistical analysis on by pressing:
trace:

Use the knob to select the desired trace.

- 4 Select the Vertical Histogram function by pressing:
*histog;, HORZNTL HISTOGM*HORZNTL HISTOGM

Acquire the Data

- 5 Define the window for taking histogram data by pressing:
other, WINDOW MARKER1, WINDOW MARKER2

Notice the values of the marker positions are indicated at the top of the display.

Tutorial 11: Create a Horizontal Histogram

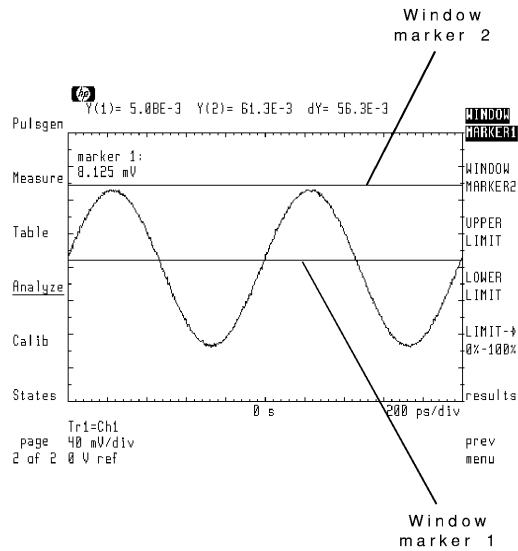

- 6** Enter the number of samples to be taken for the histogram by pressing:

prev menu, NUMBER SAMPLES, # of samples, ENTER

The default number of samples taken is 1000.

- 7** To draw the horizontal histogram, press:

SINGLE ACQUIRE

Data will be acquired once.

- 8** To continually acquire and update the histogram, press:

CONT ACQUIRE

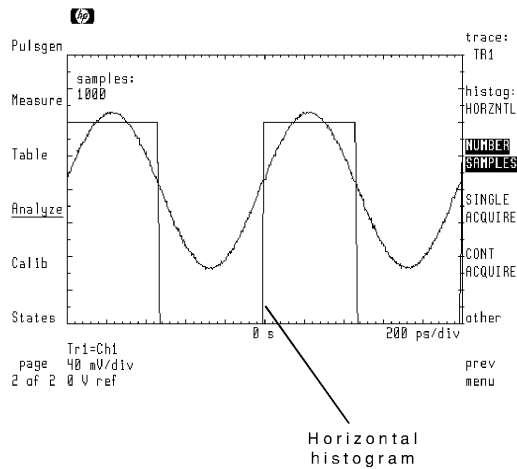

Perform Statistical Analysis

The range of sample points used to calculate the mean and standard deviation is the full screen.

- 9 To change the limits, press:

other, *UPPER LIMIT*, *LIMIT*→ 0%-100%, new upper limit value, *ENTER*,
LOWER LIMIT, *LIMIT*→0%-100%, new lower limit value, *ENTER*

Notice the values of the limit-line positions are indicated at the top of the display.

Tutorial 11: Create a Horizontal Histogram

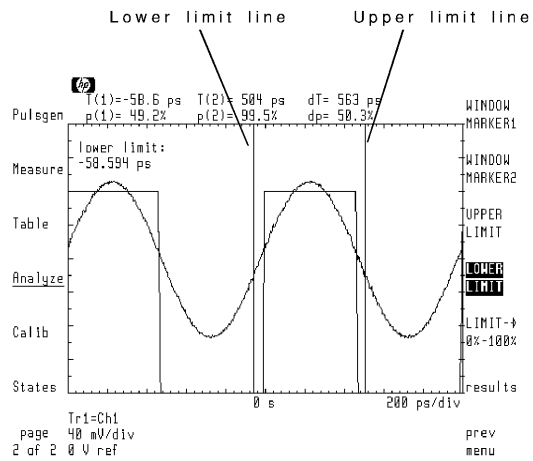

10 To display a line indicating the location of the mean, press:

results, MEAN

The mean and standard deviation values are also shown.

- 11** To display a line indicating the location of the standard deviation, press:

STD DEV

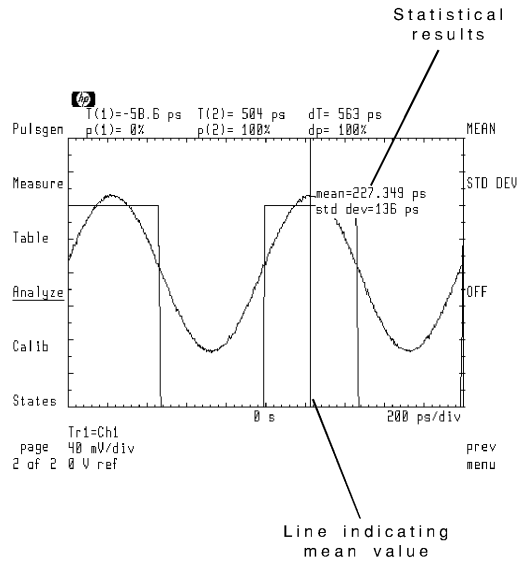

Tutorial 11: Create a Horizontal Histogram

Eye-Diagram Analyzer Reference

Eye-Diagram Analyzer Reference

In this chapter, you will find information on the following topics:

- [Performing Eye-Diagram Measurements](#) 3-3
 - [Generating Histograms](#) 3-7
 - [Masks and Limit Lines](#) 3-9
 - [Eye-Diagram Menu Maps](#) 3-12
 - [Agilent 70820A Menus](#) 3-14
 - [Controlling the Display](#) 3-16
 - [Calibrating the Eye-Diagram Analyzer](#) 3-23
 - [Displaying Traces](#) 3-25
 - [Using Markers](#) 3-30
 - [Applying Mask Testing](#) 3-31
 - [Saving to Mass Storage](#) 3-34
 - [Creating Copies of the Display](#) 3-47
 - [Agilent 70820A User-Corrections](#) 3-49
 - [Agilent 70820A Calibration](#) 3-61
-

Performing Eye-Diagram Measurements

To perform the automatic eye-diagram measurements, use the Measure menu. With the exception of extinction ratio, these measurements must be performed in eye mode.

Automatic Measurements

The Measure menu's top two softkeys automatically start measurements:

- EXTINCT RATIO
- MEASURE EYE

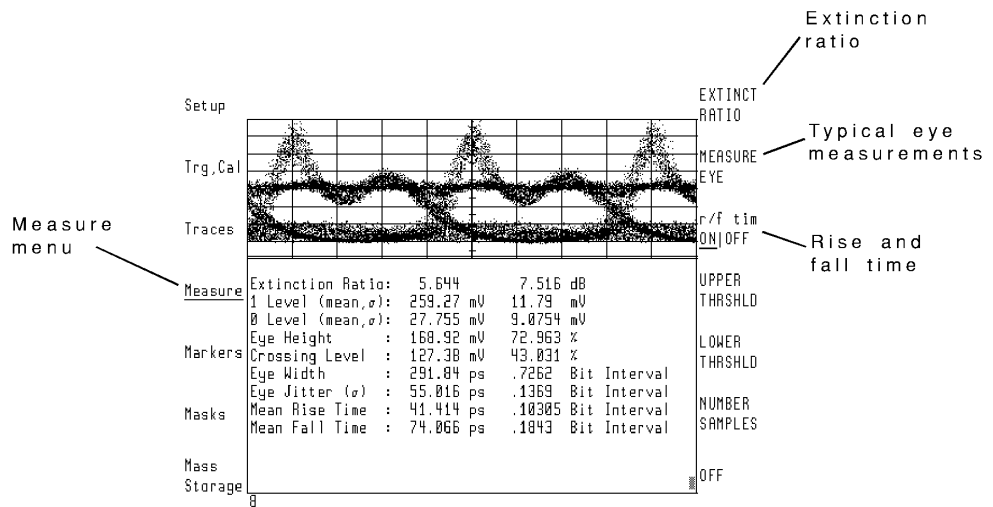

- Use the EXTINCT RATIO softkey to automatically compute the extinction ratio in eye or eyeline modes. This measurement is a ratio of the most prevalent logical one level divided by the logical zero level over one bit interval. When making extinction ratio measurements in eyeline mode, the number of samples should be increased from the default of 1000 to approximately 20000. This insures that a number of traces are evaluated to compute the extinction ratio.

Performing Eye-Diagram Measurements

Use the NUMBER SAMPLES softkey for this purpose.

- Use the MEASURE EYE to initiate a number of automatic histogram measurements on an eye-diagram.
- Use the r/f tim ON OFF softkey to enable rise time and fall time measurements during the measure eye routine. This approximately doubles the measurement time.
 - Use the UPPER THRSHLD and LOWER THRSHLD softkeys to set the upper and lower edges for rise time and fall time measurements. These softkeys define the amplitude level to be used for the upper and lower parts of an edge definition for the automatic measurement functions.
 - The default upper threshold is 80%. The default lower threshold is 20%.

Measurement Definitions

Extinction Ratio

This measurement is the ratio of the most prevalent high level to the most prevalent low level over one bit interval. The measurement results are displayed in both linear and logarithmic ($10\log$) forms of the ratio.

The peaks of the histogram are used to set initial limits for the computation of the one and zero levels. The initial mean and sigma of the one level is based on histogram data above the relative 50% point of the peaks. The limits for the next evaluation of the histogram data are set to the initial mean plus-or-minus one sigma. The new mean and sigma for the one level is determined. This process iterates several times until the sigma becomes small and the mean converges on the most prevalent one level. The determination of the most prevalent zero level is based on the same algorithm, except the initial mean and sigma of the zero level are based on histogram data below the relative 50% point of the peaks.

1 Level (mean, σ)

This measurement is the mean and sigma of the one level determined from a 20% window of a bit interval centered in the middle of the bit.

0 Level (mean, σ)

This measurement is the mean and sigma of the zero level determined from a 20% window of a bit interval centered in the middle of the bit.

Eye Height

This measurement is the difference between the mean minus-three sigma of the one level and the mean plus-three sigma of the zero level.

- Crossing Level** This measurement is the amplitude that the one level and zero level cross. It also expresses the level as a percentage of the mean one level and mean zero level difference.
- Eye Width** This measurement is the eye width determined from the bit period and the eye jitter. On the eye, the edges are defined to be the left crossing point plus-three sigma and the right crossing point minus-three sigma.
- Eye Jitter (σ)** This measurement is the sigma of a horizontal histogram at the crossing point.
- Mean Rise Time** This measurement is the mean time interval between a horizontal histogram centered at the lower threshold point and a horizontal histogram centered at the upper threshold point on a rising edge of an eye-diagram.
- Mean Fall Time** This measurement is the mean time interval between a horizontal histogram centered at the upper threshold point and a horizontal histogram centered at the lower threshold point on a falling edge of an eye-diagram.

Measure Fast Amplitude and Phase Transitions

The 70820A module measures fast amplitude and phase transitions on continuous wave (CW) and modulated signals. Time, frequency, and power sweeps can be performed from dc to 40 GHz. The 70820A module triggers on the RF input signal.

During stimulus/response measurements, the 70820A module controls an RF source instrument's:

- frequency
- power
- pulse modulator

Viewing Repetitive and Non-Repetitive Signals

Because of the sampling techniques employed by the 70820A, the 70820A module is optimized for viewing repetitive input signals. However, there is single-shot operation for viewing baseband and modulated non-repetitive signals having bandwidths up to 10 MHz. Pre-trigger data can also be viewed. An example of using the single shot operation is measuring the turn-on characteristics of a pulse modulator. Single shot operation uses a maximum sampling rate of 20 MHz.

For Optimum Performance

The 70820A module should be configured to:

- Control the RF source over the communications bus.
- Share the same frequency reference as the RF source.

Channels Versus Traces

The 70820A module has two input channels, four traces, and four trace memory registers.

- Channels are used to measure input signals.
 - Traces are used to display measurement results.
 - Trace memory registers can be used as a third channel.
-

Generating Histograms

The 70820A can perform statistical analysis on any displayed trace. After creating a vertical or horizontal histogram of the trace data, the display can show mean and standard deviation values of the histogram.

Histogram analysis is performed using the Histogram menu.

Press:

MENU, the left-side *page 1 of 2, Analyze, Histogram*

The 70820A menus perform vertical or horizontal histograms on any single trace

You can control the number of samples taken, the window for valid data samples, and the sample bounds for calculating mean and standard deviations

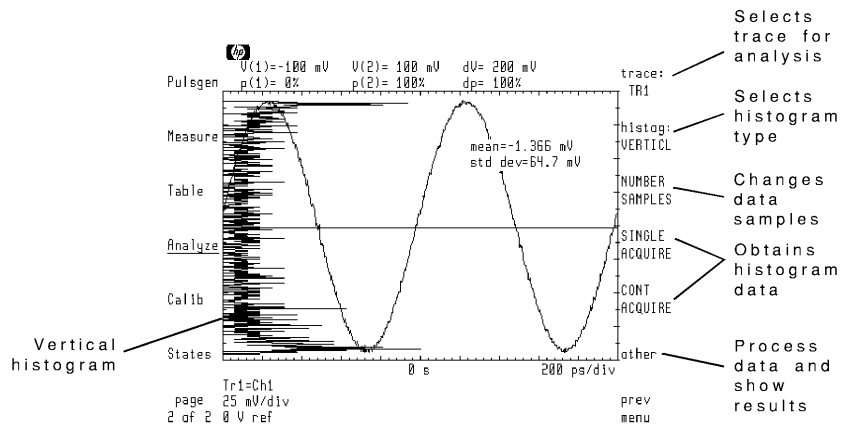

The Histogram Menu

Generating Histograms

When generating histograms, you must perform the following basic steps:

- 1 Select a trace.
- 2 Select histogram type.
- 3 Enter the number of samples.
- 4 Set limits for acquired data.
- 5 Acquire the data.
- 6 Establish limits for statistical analysis.
- 7 View the mean and standard deviation.

Histogram data can be acquired once using the *SINGLE ACQUIRE* softkey or continuously updated using the *CONT ACQUIRE* softkey.

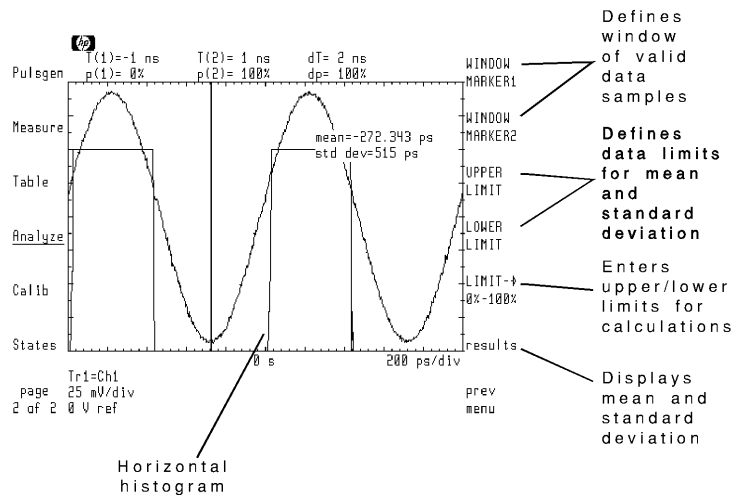

Press *other* for this additional menu.

Masks and Limit Lines

Masks and limit lines allow you to test the shape (time or frequency versus amplitude) of a displayed response. Masks are closed polygon shapes. Limit lines are lines. Traces or measurement points that penetrate a mask or cross a limit line result in testing errors.

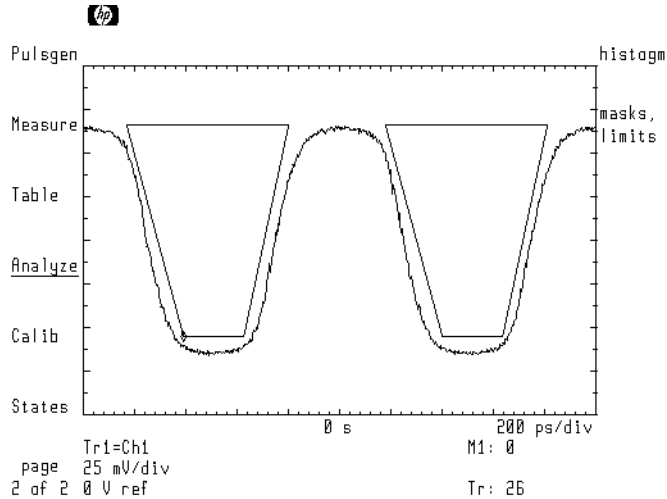

Two Masks Displayed on Screen

Masks and Limit Lines

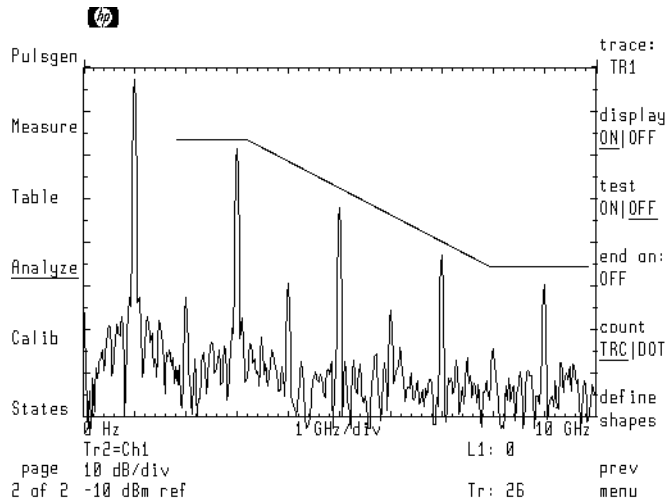

A Limit Line Displayed on Screen

Because you can perform repetitive testing of response shapes, masks and limit lines are ideal for pass/fail testing on production lines. You create, save, recall, and edit limit lines using the masks, limits menu. Access this menu using the left-side Analyze softkey.

Since masks and limit lines are treated similarly, in this chapter, most references to masks applies equally to limit lines.

Testing Responses

Once you've created a mask or limit line, set the following conditions for testing:

- Trace to which testing is applied.
- Violations defined as traces or measurement points.
- Testing ends after a set number of errors.
- Testing ends after a set number of traces.

Use the test ON|OFF softkey to start testing. Testing stops whenever one of the following events occurs:

- A set number of trace sweeps.
- A set number of violations.
- test ON|OFF is set to OFF.

Numbers displayed at the bottom of the screen indicate the number of violations and trace sweeps that have occurred. The following figure shows a response that has violated a limit line three times on three sweeps.

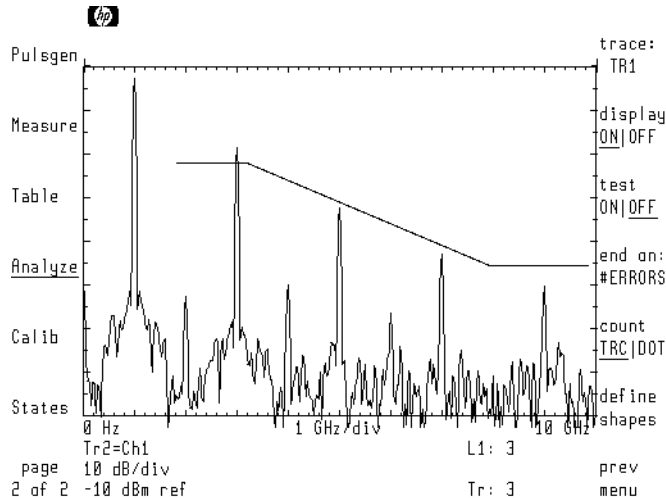

Eye-Diagram Menu Maps

The two menu maps in this section graphically represent the eye-diagram analyzer's softkey menus.

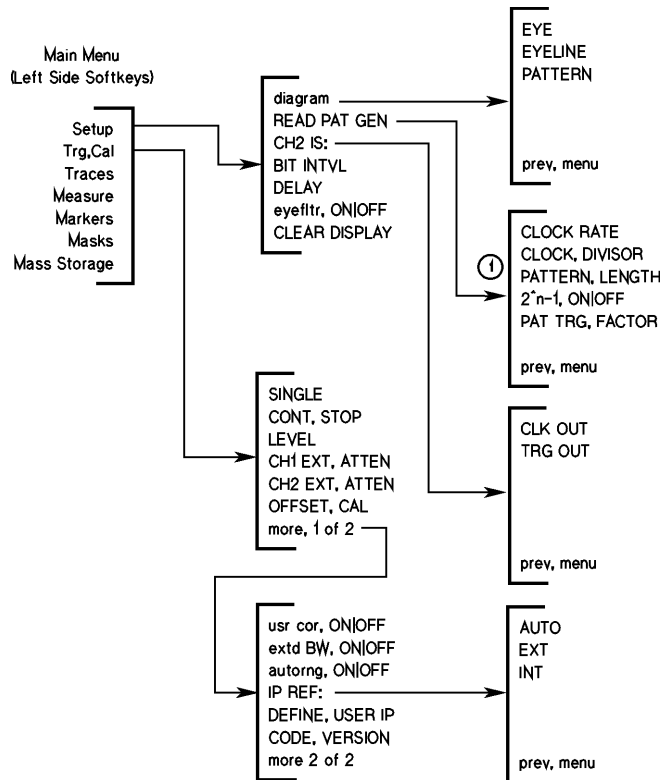

① Some of the keys in this menu may appear depending on the pattern generator and clock source configuration.

menu1

Setup and Trg, Cal Menus

Eye-Diagram Menu Maps

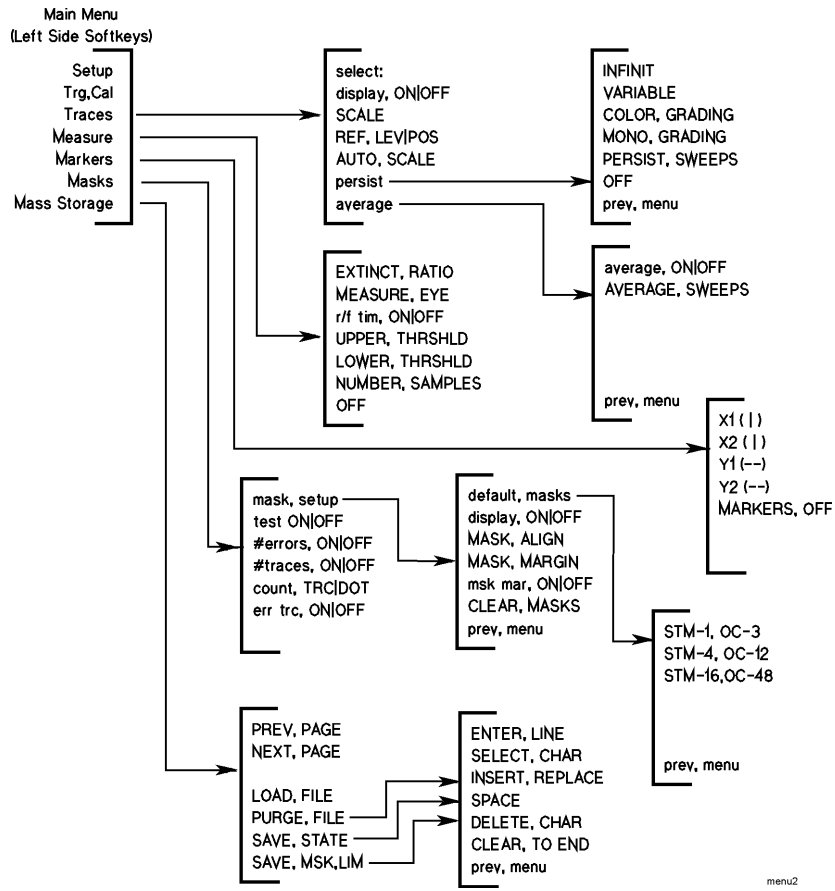

Traces, Measure, Markers, Masks, and Mass Storage Menus

Agilent 70820A Menus

This section discusses the softkey menus for the 70820A microwave transition analyzer module. To learn about the eye-diagram analyzer's menus, refer to [“Eye-Diagram Menu Maps” on page 3-12](#). These menus provide additional features useful for running the eye-diagram analyzer.

You will find the preview feature discussed in this chapter very useful. It displays the programming command, corresponding to the response received, when most softkeys are pressed.

Most front-panel controls are accessed via softkey menus. Softkeys are the seven buttons located on each side of the screen. The functions of softkeys change according to the menus displayed on the screen.

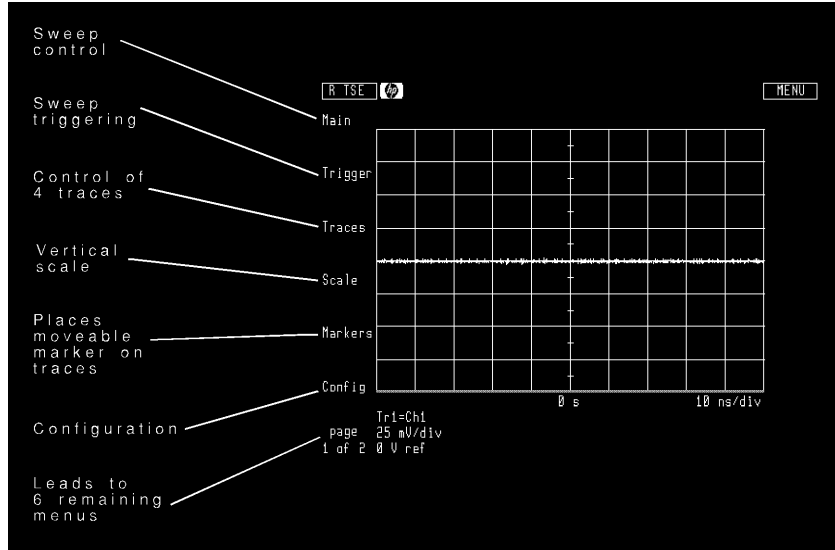

The Left-Side Softkeys

Use the softkeys located on the left side of the display to access the twelve major menus. These softkeys are shown in two pages. Press *page 1 of 2* to view the second page of softkeys. When the 70820A module first turns on, the Main menu is automatically selected.

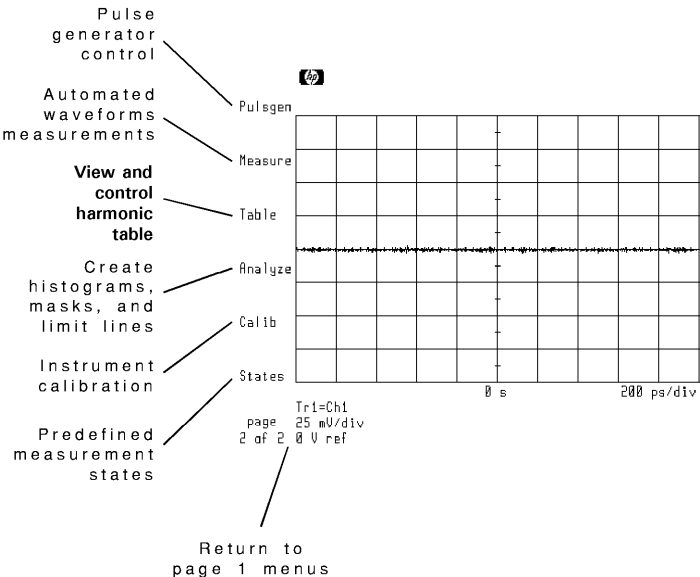

Page 2 of Top Level Menus

Controlling the Display

To Control the Number of Bits Displayed

The Setup menu's BIT INTVL softkey allows you to select the number of bits that will be displayed on the screen. The horizontal time scale automatically changes to the appropriate setting. Use DELAY to enter time delay. The amount of delay is entered in bits. Use this feature, in pattern mode, to view different portions of the PRBS waveform.

The amount of delay can be as much as 1000 times the time span. In addition, the eye-diagram analyzer can view the trace before the trigger event. Negative time delay up to $\{-\text{time span}\}/2$ can be entered.

Set the number of bits displayed by pressing:

Setup, BIT INTVL and enter the number of bits to display.

Set the time delay by pressing:

Setup, DELAY and enter the desired time delay

To Measure in Optical Power Units

The Trg, Cal menu's CH1 EXT ATTEN and CH2 EXT ATTEN softkeys allow you to specify any external attenuation or optical-to-electrical responsivity conversion between the source and input channels. Specifying an attenuation on channel 1 changes the measurement plane from the front-panel channel 1 connector to include the indicated attenuation. Specifying an optical-to-electrical responsivity displays optical units referenced to the input of the optical-to-electrical converter. Channel and marker readouts change to watts/div. Also, the CH1 EXT ATTEN softkey changes to read CH1 RSPVTY (responsivity).

To measure the optical power, press:

Trg, Cal, CH1 EXT ATTEN and enter the responsivity value in watts/div

Notice the CH1 EXT ATTEN softkey changes to read CH1 RSPVTY (responsivity).

To Improve the Sensitivity in Eyeline Mode

In eyeline mode, additional eye filtering can be applied to improve the measurement sensitivity. This can be an advantage when measuring extinction ratios on low-level signals. Use the `eyefltr ON OFF` softkey to apply the filter. When the pattern repetition frequency is greater than 10 MHz, internal filtering is applied that provides a 20 dB signal-to-noise improvement. For pattern repetition frequencies less than 10 MHz, software filtering is applied that allows variable signal-to-noise improvement versus sweep time.

To improve sensitivity, press:

Setup, diagram, EYELINE or PATTERN, eyefltr ON OFF ON

Use the front-panel knob to adjust the amount of filtering applied.

To Extend the Bandwidth to 40 GHz

Use the `extd BW ON OFF` softkey to enable RF corrections which extend the measurement bandwidth of the eye-diagram analyzer to 40 GHz. Extended bandwidth operation can be used in both eyeline and pattern modes, but not in eye mode.

- 1 Extend the measurement bandwidth by pressing:

Setup, diagram, EYELINE or PATTERN

The extended 40 GHz bandwidth cannot be used in eye mode.

- 2 Turn the extended bandwidth on by pressing:

Trg, Cal, more 1 of 2,, extd BW ON/OFF ON

To Apply User-Corrections

User-corrections provide a convenient method for modifying the display of input signals. Some of the applications for user-corrections include the following:

- Filtering input signals to simulate the effects of circuit design.
- Compensating for frequency and phase response of external probes.
- Compensating for frequency and phase response of external test setups.
- Compensating for the frequency response of optical to electrical converters.

Several Bessel-Thomson software filters are included on the 70874A eye-diagram analyzer's memory card. These filters can be applied as user-corrections in the eyeline and pattern modes. (User corrections must be off in eye mode.) User correction files are identified by the prefix `a_` as shown in the following table. The files `AUTOST` and `70874` comprise the eye-diagram analyzer program.

Controlling the Display

To learn more about these files and about creating and applying user-corrections, refer to [“Tutorial 5: Use Software Filters” on page 2-15](#).

User-Correction Files

File Name	File Data
a_bt248832	4th order Bessel- Thomson filter for 2.48832 Gbit/sec transmission.
a_bt_62208	4th order Bessel- Thomson filter for 622.08 Mbit/sec transmission.
a_bt_15552	4th order Bessel- Thomson filter for 155.52 Mbit/sec transmission.

- 1 Place the 70874A eye-diagram analyzer memory card in the front-panel card slot.

The 70874A eye-diagram analyzer must already be loaded into memory.

- 2 Display the eye-diagram analyzer's menus by pressing:

USER, *Setup*, *diagram*, *EYELINE* or *PATTERN*

User corrections can not be applied in eye mode.

- 3 Display a catalog of the files contained on the memory card by pressing:

Mass Storage

Rotate the front-panel knob to highlight the desired file.

User correction files are identified by the prefix a_.

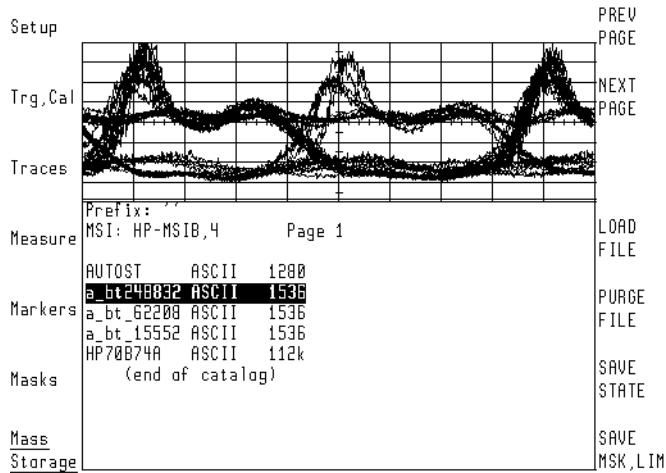

- 4 Load the file by pressing:

LOAD FILE

The file is loaded when user-corrections loaded is displayed on the screen.

- 5 Turn the user correction function on by pressing:

Trg, Cal, more 1 of 2, usr cor ON/OFF ON.

Controlling the Display

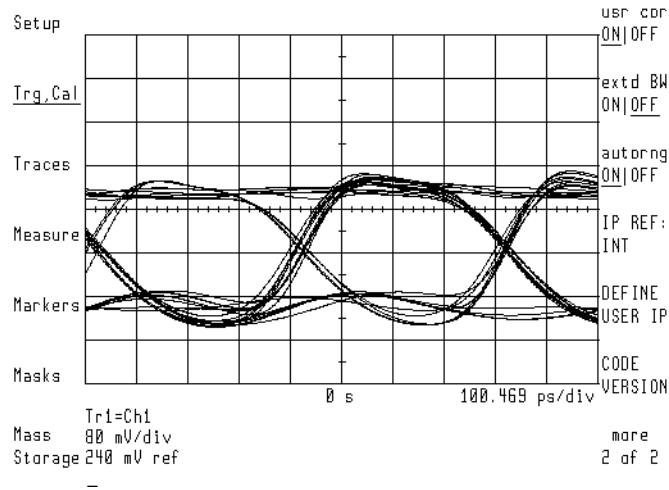

User-Corrections Applied to the Data

To View 70820A Menus

Press **MENU**.

To Return to the Jitter Analyzer (or Eye-Diagram Analyzer)

Press **USER**.

If the eye-diagram analyzer's menus are not displayed, load the program as explained in [Chapter 1, "Getting Started"](#).

To Preview Programming Commands

Press **MENU**, *Config, more 1 of 3, preview ON|OFF* ON

For a demonstration of the Preview function, press persist ON|OFF. Notice the corresponding programming command DISP:PERS 1024 is displayed at the bottom of the screen.

To View the Firmware Date Code

Press **MENU**, *Config, more 1 of 3, more 2 of 3, system, ROM VERSION*

To View the Date and Time

There are two clocks that can be displayed on the screen: the display's clock and the 70820A module's clock. You can control whether the clocks are displayed, the indicated time, and the display format. When the mainframe is turned on, the display sets the clock in the 70820A module. This causes both clocks to indicate the same time.

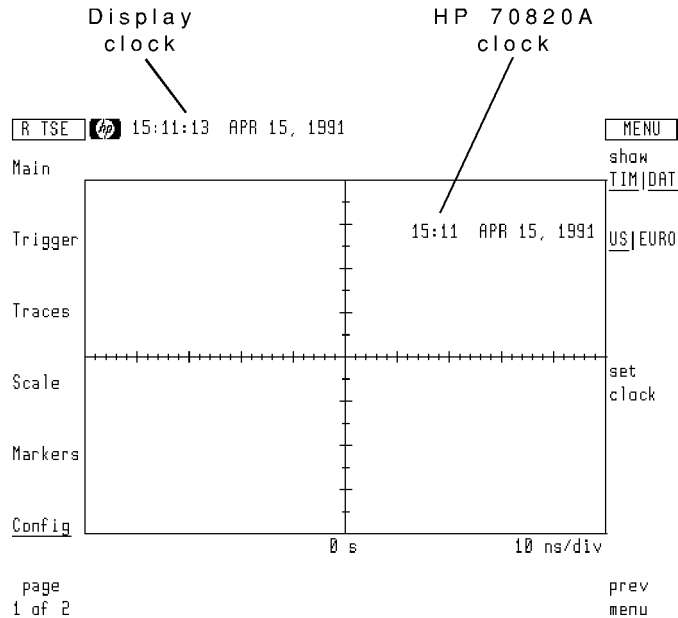

Control the 70820A's Clock

- 1 To control the 70820A's clock, press:
MENU, *Config, more 1 of 3, clock*
- 2 To display the time or date, press:
*show TIM/DAT*TIM
or:
*show TIM/DAT*DAT

The time and the date can be displayed simultaneously.

Controlling the Display

- 3** To select US or European display format, press

US/EURO US

or:

US/EURO EURO

- 4** To change the time or date, press:

set clock

Enter the new value in the same format as displayed.

Control the Display's Clock

- 1** Press **DISPLAY**, *Misc*, *clock*

- If you want to turn the clock display on and off, press *CLOCK DISPLAY*.
- If you want to select US or European display format, press *US/EURO*.
- If you want to change the time or date, press *set clock*.

- 2** Enter the new value in the same format as displayed.
-

Calibrating the Eye-Diagram Analyzer

Note

For information on user-corrections and instrument calibration data, refer to “Agilent 70820A User-Corrections” on page 3-49 and refer to “Agilent 70820A Calibration” on page 3-61.

To Compensate for dc Offsets

An offset calibration routine is provided that allows the eye-diagram analyzer to compensate channel 1 for any external or internal dc offsets. This ensures accurate measurements of the laser’s one and zero levels. For example, you can use the calibration to remove any offset that may be present in an optical-to-electrical converter. This is sometimes referred to as the “dark” level.

To perform an offset calibration

- 1 Turn the laser off and then press:

Trg, Cal, OFFSET CAL, CONT

The calibration takes about a minute to execute. When the calibration is finished, DC NULL: done is displayed.

- 2 Turn the laser on.

To Calibrate IF for Accuracy

The 70820A microwave transition analyzer module provides separate automatic IF calibration routines for channel 1 and channel 2. Each requires approximately 30 minutes to run. For optimum performance, you should perform the calibrations when at least one of the following is true:

- The temperature has changed $\pm 5^\circ$ Centigrade since the last calibration was performed.
- More than one week has passed since the last calibration.
- Before any critical measurement.

CAUTION

Allow the microwave transition analyzer module to warm up for at least one hour before performing a calibration.

Calibrating the Eye-Diagram Analyzer

- 1 Connect a low-loss cable between the front-panel CALIBRATOR OUTPUT and channel 1 connectors.

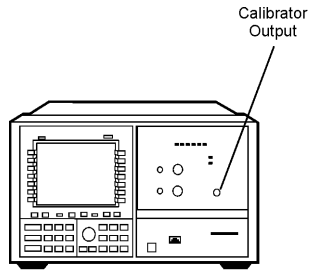

pta22

- 2 To calibrate the IF, press:

MENU, *page 1 of 2*, *Calib*, *IF calib*, *CAL CH1*

The calibration routine takes about 30 minutes to complete.

- 3 Disconnect the cable from channel 1, and connect it to the channel 2 connector.
- 4 Repeat the above procedure for channel 2.

Displaying Traces

Four Traces can be Displayed

The Traces menu's select: softkey allows you to display and control up to four traces. The scaling, reference positions, and reference levels of each trace can be separately adjusted. To automatically adjust the trace scale factor and reference level for optimum display, simply press AUTO-SCALE. Signals are autoscaled once when the softkey is pressed and not on a continual basis. If you change the amplitude of the signal, it will not be autoscaled.

During mask testing, trace 4 is reserved for the error trace.

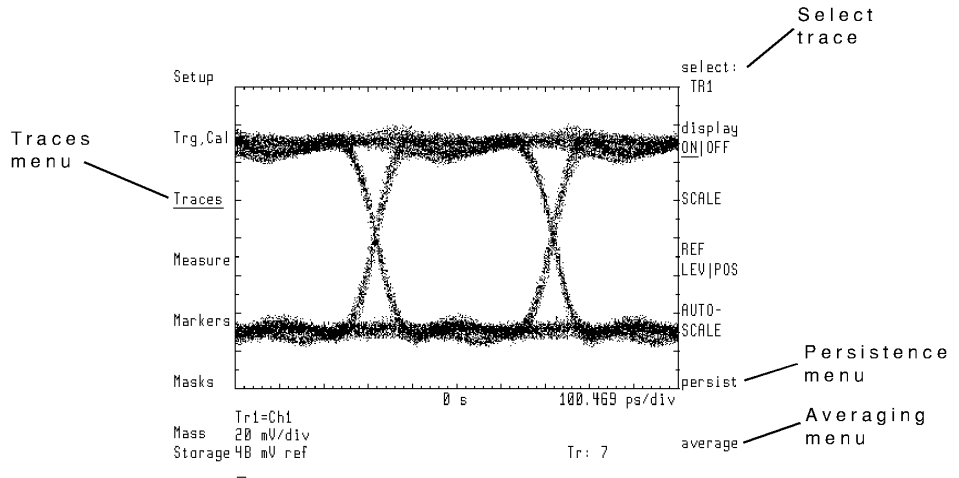

To Display a Trace Press *Traces*, *select:*, *TR1*, *TR2*, *TR3*, or *TR4*, *display ON OFF* ON

Displaying Traces

To Position and Scale Each Trace

The selected trace can be positioned vertically on the display. This is accomplished using the *REF LEV/POS* softkey to enter both the reference position and reference level. The reference position (POS) is entered as a percentage of the vertical display. The top of the screen is 100%. The bottom of the screen is 0%. The reference level (REF LEV) is the amplitude value at the reference position.

To scale and position a trace, press:

Traces, AUTO-SCALE to automatically scale the selected trace.

or

SCALE to manually set the scale.

Use the front-panel knob or numeric keypad to change the displayed vertical scaling.

REF LEV/POS POS to move the trace's reference position.

Rotate the front-panel knob to change the position.

REF LEV/POS LEV to change the reference level at the trace's reference position.

Rotate the front-panel knob to change the level.

To Average Trace 1

The Traces menu's average softkey presents a menu used for controlling trace averaging. Trace averaging keeps a running average of the measurement values on each sweep. You can set the averaging count; its default value is 16. Trace averaging is only applied to trace 1.

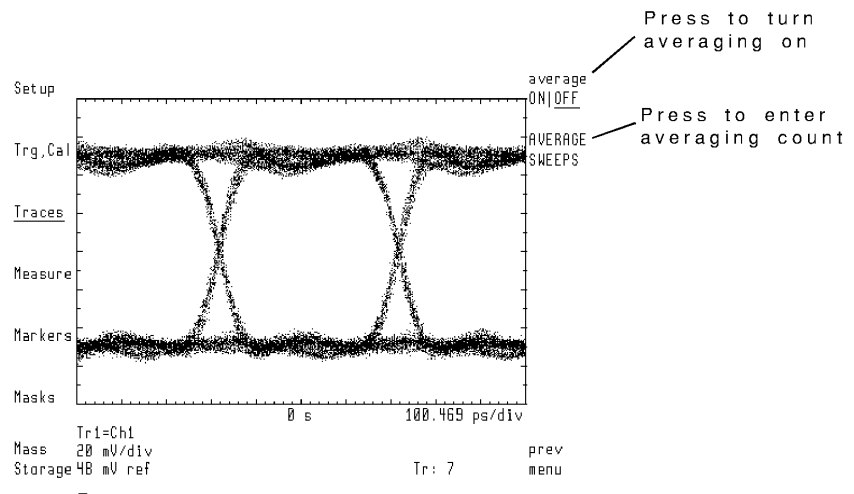

The Averaging Submenu

Average trace 1 by pressing:

Traces, *average*, *AVERAGE SWEEPS* and enter the number of sweeps used for running average, *average ON/OFF ON*

Four Persistence Modes are Available

The eye-diagram analyzer offers four trace persistence selections. These selections are located under the Traces menu's persist softkey and include the following types:

- Infinite monochrome
- Variable monochrome
- Color grading
- Monochrome grading

Trace persistence works on all displayed traces regardless of which trace is selected.

Displaying Traces

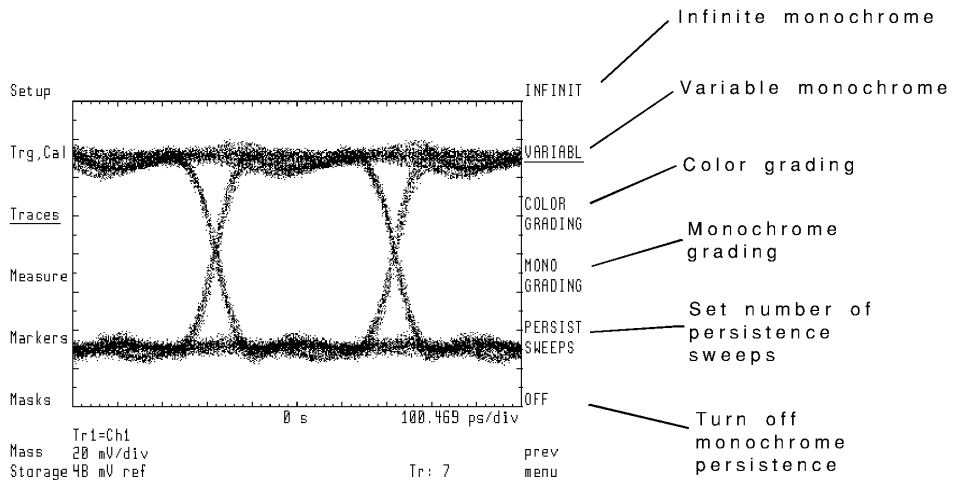

The Persistence Submenu

Infinite Monochrome Persistence

With infinite monochrome persistence (INFINIT), traces accumulate on the display until persistence is turned off or the display is cleared using the Setup menu's CLEAR DISPLAY softkey. Press OFF to turn off infinite monochrome persistence.

Variable Monochrome Persistence

With variable monochrome persistence (VARIABL), older traces become dimmer as new traces are acquired. Traces can be one of seven different brightness levels, with new traces being the brightest. After N number of sweeps (N is set with the PERSIST SWEEPS), every trace gets dimmer by one intensity level; traces already at the dimmest level disappear altogether. Lower values of N work best with this type of persistence, typically values of five through 10. Press OFF to turn off this persistence.

Color Grading Persistence

With color grading persistence (COLOR GRADING), the color of a displayed pixel is a function of how many times a trace dot falls on that particular pixel. There are five possible colors that a pixel can be. If a pixel has progressed to the highest color (yellow) before N PERSIST SWEEPS have occurred, it remains that color no matter how many more dots fall on it. After N PERSIST SWEEPS, the color grading acquisition stops. The following list shows the order of colors a pixel can progress through:

- 1 green
- 2 cyan (light blue)
- 3 purple
- 4 rose
- 5 yellow

This persistence works best with high values of N, typically values of 50 through 100. In this mode, no softkeys can be pressed until *after EXIT GRADING* is pressed.

Monochrome Grading Persistence

Monochrome grading persistence (MONO GRADING) works just like color grading except that a given pixel increases in intensity instead of color each time a dot falls on it. There are 15 different levels of intensity. In this mode, EXIT GRADING must be used to return to normal instrument operation.

- a Apply persistence by pressing:

Traces, persist, PERSIST SWEEPS

Enter one of the following:

- If variable persistence will be used, enter the number of sweeps taken before a trace decrements in brightness.
 - If grading persistence will be used, enter the number of sweeps taken until the grading display is stopped.
- b Press one of the four top right-side softkeys to select the persistence mode.
 - c Pressing *OFF* can stop *INFINIT* and *VARIABLE* persistence at any time.

Using Markers

Use this menu to activate the four available line markers: X1, X2, Y1, and Y2. Markers allow you to measure or compare portions of the displayed waveform. For example, you can use markers to measure the peak-to-peak difference in a laser's turn-on time as measured on the eye-diagram's crossing point.

Use the front-panel knob or numeric keypad to position each displayed marker on the screen. Notice that the value at the marker is displayed on the top portion of the screen. To turn the markers off, simply press MARKERS OFF.

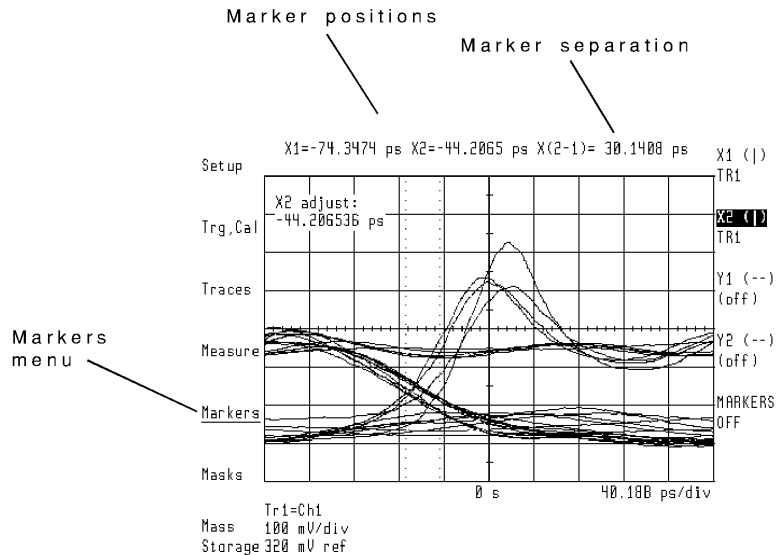

Applying Mask Testing

Use the Masks menu to display and control mask testing. Built in standard masks for the more common SONET/SDH transmission rates are provided. To learn how to create your own custom masks, refer to [Chapter 2, “Application Tutorials”](#).

Test Results are Displayed

During mask testing, mask violations are displayed in the lower portion of the display. You can specify whether the mask errors are counted as trace errors or as the number of trace points or dots that violated the mask. You do this using the count TRC|DOT softkey.

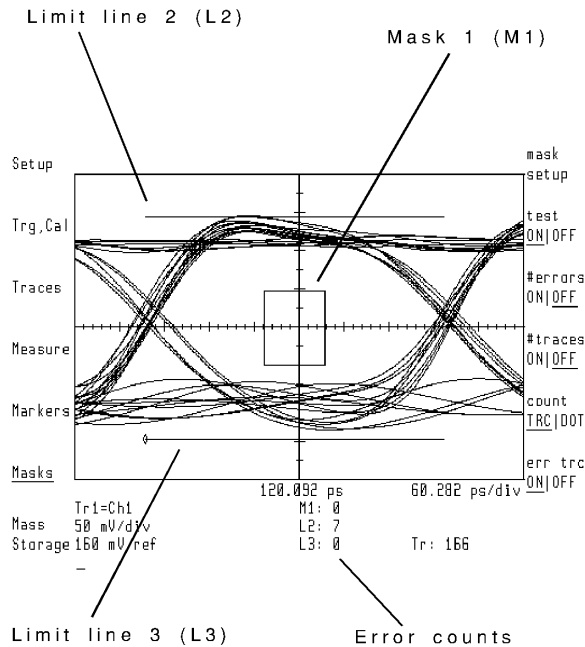

Applying Mask Testing

Automatic Alignment Scales the Mask

The MASK ALIGN softkey, located under the Masks menu, automatically aligns and scales a default mask to the data per the SONET/SDH standards. This is accomplished using histograms and is best done in eye mode for faster and more evenly distributed data acquisition. Eye mode provides a more even statistical distribution of high and low data. This results in faster acquisition of the histogram data used to determine zero and one levels. The mask and limit lines adjust to fit the displayed data. To change the number of samples used for the histogram, use the Measure menu's NUMBER SAMPLES function.

Display the Error Trace

Use the err trc ON OFF softkey to display a trace that violates a mask. The screen is split with the error trace displayed in the lower half of the display. Trace four is allocated as the error trace.

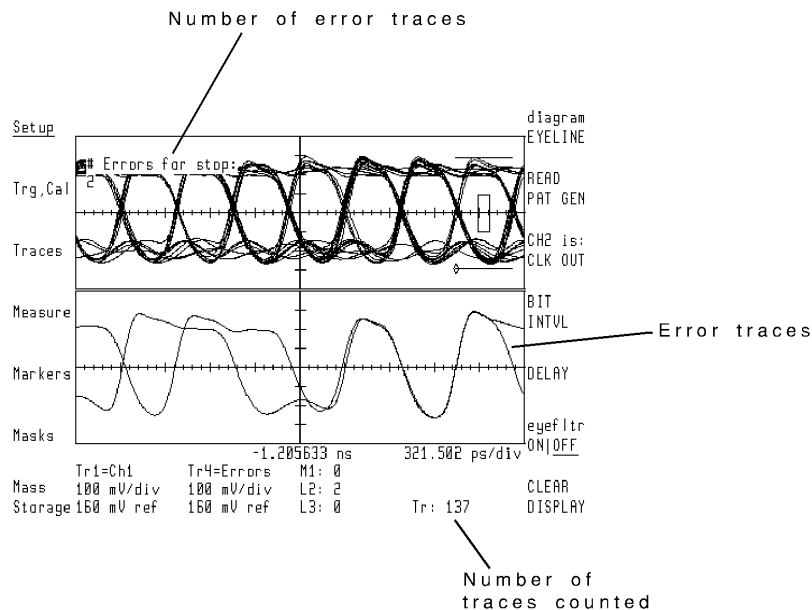

Mask Margins Tighten Mask Tests

Margins can be added to the mask/limit line tests. This margin is added as a percent of the mask. Zero percent margin corresponds to the default mask. One hundred percent margin corresponds to the mean of the histograms of the one and zero levels, and the crossing points.

Negative mask margins can also be implemented. These can be used to gain an idea of time severity of the encountered errors.

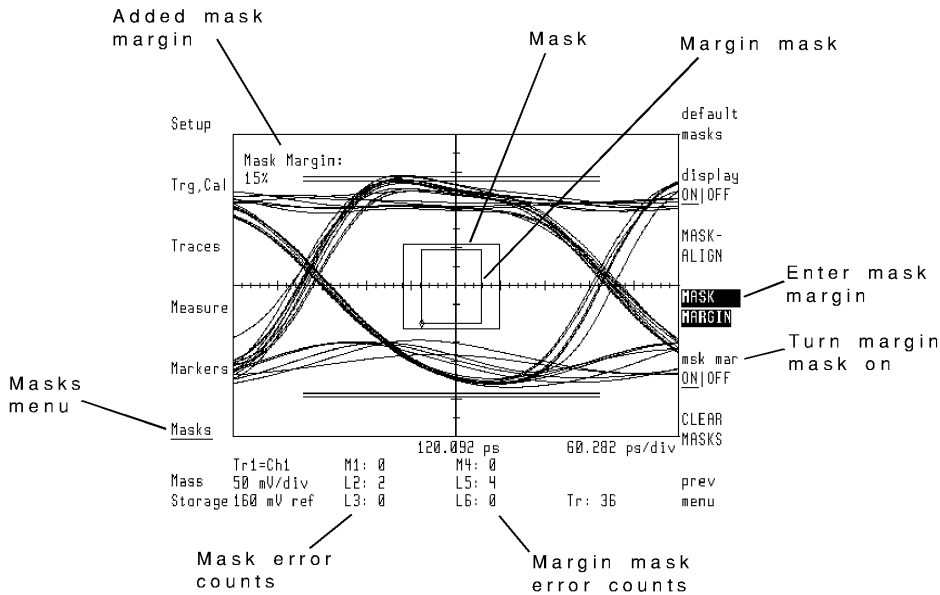

The Mask Setup Submenu

Saving to Mass Storage

Use the Mass Storage menu, to save and recall files to a mass storage device. The mass storage device is normally a memory card that has been inserted into the front-panel card slot. You can also store data to a GPIB disk drive, and to internal random-access memory (RAM) disk, refer to [“Selecting and Formatting Memory” on page 3-34](#).

Each file that you save has a name that consists of a prefix followed by a custom name that you enter. The analyzer assigns a prefix according to the type of data. Refer to [“Working with Files” on page 3-40](#).

The following list shows the types of data that can be saved as files:

- Traces
- Measurement states
- Histograms
- Masks
- Limit lines
- Calibrations
- User corrections
- User menus
- Downloadable programs (DLPs)
- Jitter template and calibration files

Selecting and Formatting Memory

When first turned on, the microwave transition analyzer module automatically selects the memory card as the mass-storage device. You can format memory and save, recall, erase, and list (catalog) files using the mass-storage menu located in the States menu.

Memory Cards

Memory cards must be formatted before use. Formatting erases any previously stored files and initializes memory for storing data. RAM memory cards have a built-in battery to retain memory data. Data stored in the card remain

as long as the card's battery has sufficient power. You should change the battery every two years using the procedure in this section. Refer to ["To Change a Memory Card Battery" on page 3-39](#).

RAM memory cards have a write-protect switch, on the end which is not inserted into the display's card slot. If this switch is slid toward the edge of the card (marked "SAFE"), no changes may be made to the card's content. If you wish to write a new file to a card, or remove a file, slide its write-protect switch toward the center of the card.

Note

If no card is inserted in the front-panel card slot, and you attempt to catalog a memory card, the display shows the message catalog open failed. Place a card in the card slot, and retry the operation.

RAM Disks

RAM disks offer a convenient method of duplicating memory cards. Refer to ["To Duplicate a Memory Card" on page 3-41](#). Up to 16 internal RAM disks can be created. (These are numbered 0 through 15.) The default size of each RAM disk is 32 kilobytes.

Use Instrument BASIC's INITIALIZE statement to create each disk. The following example creates RAM disk zero:

```
INITIALIZE " :MEMORY, 0, 0" , 128
```

The second integer, 0, determines the RAM disk number. The value 128 represents the size of the RAM disk in sectors. Each sector consists of 256 bytes. So, a value of 128 sectors creates a RAM disk of 32 kilobytes. A value of 512 sectors creates a RAM disk of 128 kilobytes.

Use the following command to create RAM disk 1 with a size of 128 kilobytes:

```
INITIALIZE " :MEMORY, 0, 1" , 512
```

CAUTION

Because internal RAM is volatile, all RAM disks are deleted when the power is turned off. When this happens, all files are lost and each RAM disk must be recreated.

Saving to Mass Storage

GPIB Disk Drives

Measurement data and files can be saved on an external GPIB disk drive. The disk drive must be a 3.5 inch, CS80 compatible, such as an 9122. To use the drive, you must connect it and enter its GPIB address using DISPLAY menu softkeys. The procedure in this section shows you how to do this. You will need to know the disk drive's GPIB address, unit number, and volume number.

The GPIB address is represented by a digit from 1 through 7. The unit number indicates an individual slot in the disk drive. Although unit numbers can range from 0 through 9, they are typically 0 or 1. The volume number is used for hard disk drives. For reading diskettes, the volume number should be 0.

To Use a Memory Card

- 1** Insert the memory card into the front-panel card slot of the microwave transition analyzer, facing the metal strip on the card downward and toward the instrument. Make sure the card is fully inserted into the card slot.
- 2** Select the memory card as the mass storage device by pressing:
DISPLAY, *Mass Storage, msi:, MEMORY CARD*
- 3** To display a catalog of the files on the memory card, press:
MENU, *page 1 of 2, States, more 1 of 2, mass storage, msi:, HP-MSIB CARD*

If the message "6218 catalog open failed" is displayed, the card is not in the front-panel card slot. The HP-MSIB address for the card is the same address as the display's GPIB address and is normally set to 4. If the address is not correct, enter the correct address using the numeric keypad.

Initializing (formatting) a memory card

CAUTION

The following steps erase any files stored on the card.

- 1 If the memory card is new and needs to be formatted, press:
MENU, *page 1 of 2, States, more 1 of 2, mass storage, more, FORMAT*
- 2 To use the LIF format, press:
FORMAT as LIF
- 3 To format as DOS, press:
FORMAT as DOS

To Use an Internal RAM Disk

- 1 To invoke Instrument BASIC, press:
USER
If the eye-diagram personality is loaded, press USER again.
- 2 Enter an INITIALIZE statement to create a RAM disk. For example, enter the following BASIC statement:

```
INITIALIZE " :MEMORY, 0, 0" , 128
```
- 3 Select the internal RAM disk by pressing:
MENU, *page 1 of 2, States, more 1 of 2, mass storage, msi., MEMORY*
The RAM disk number is shown on the screen. Use the front-panel knob to change the RAM disk number.

To Use an GPIB Disk Drive

- 1 Connect the GPIB disk drive to the 70004A color display using an GPIB cable.
- 2 Determine or set the GPIB address of the disk drive. Refer to the disk drive's user's manual for information on determining the disk drive's address.
- 3 Set the GPIB address of the disk drive by pressing:
DISPLAY, *Mass Storage, msi., GPIB disk, GPIB ADDRESS*
enter the address of the disk drive
This value is between 1 and 7.

Saving to Mass Storage

- 4 Enter the disk drive's unit number by pressing:

UNIT NUMBER

This number is typically a 0 or 1. Zero usually indicates the disk drive's left side slot.

- 5 Enter the disk drive's volume number by pressing:

VOLUME NUMBER

The volume number should be left at the default value of zero for floppy disk drives.

- 6 Continue by pressing:

MENU, *page 1 of 2, States, more 1 of 2, mass storage, msi;*
HP-MSIB CARD

Although CARD is selected, the display's GPIB disk softkey, pressed in [Step 3](#), redirected communications to the GPIB disk drive.

To Change a Memory Card Battery

The memory card's battery is a lithium commercial CMOS type, part number CR 2016.

The memory card should be installed when the battery is removed. If the battery is removed while the card is not installed, all data in the card will be lost. Store memory-card files on another device before changing the battery, when extra care is appropriate.

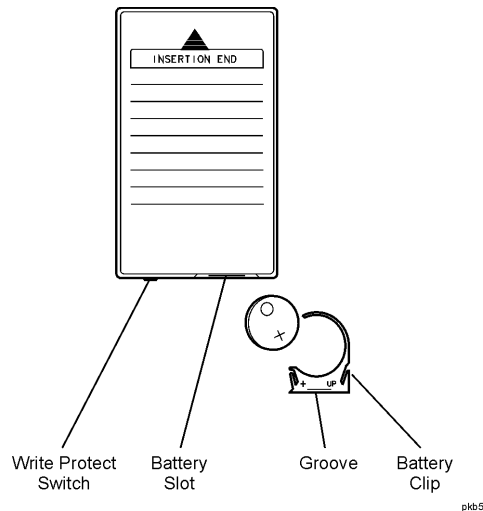

- 1 Install the memory card into the 70004A display.
- 2 On the front edge of the card, locate the groove of the battery clip.
- 3 Gently pry the battery clip out of the card. The battery fits inside the clip.
- 4 Replace the battery, making sure the plus (+) sign on the battery is on the same side as the plus sign on the clip.
- 5 Insert the battery clip into the memory card, holding the clip as oriented in the figure. (Face the open edge of the clip toward the memory card's write-protect switch.)
- 6 Write the date the battery was replaced on the card.

Working with Files

Files are identified by a prefix and a name. The eye-diagram analyzer assigns a prefix according to the type of data, as shown in the following table. You enter the file name. When cataloged, the file listings show the file's data type and size in bytes.

File Prefixes

File Type	File Prefix
Calibration data	c_
Histograms	h_
Instrument registers	r_
Instrument state	s_
Mask/Limit line	m_
Program	d_
Trace	t_
User corrections	a_
User menu	k_
Jitter template	T-

You can create additional prefix text for your file names. The text, appended to the standard prefixes, allows you to indicate files that have similar data. For example, the following figure shows a catalog of two mask files. Each file has an additional prefix of Shape. The additional prefix is appended, regardless of the type of file you are saving.

The total length of your file name cannot exceed 10 characters for LIF and 8 characters for DOS. This includes prefix and file name.

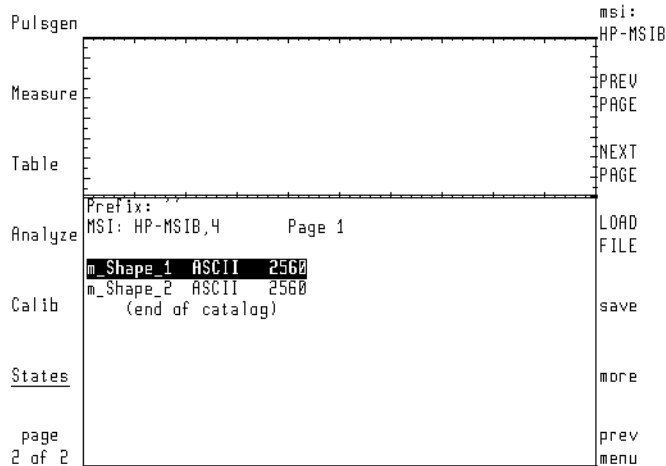

To Duplicate a Memory Card

Instrument BASIC provides the ability to mass copy all the files from one memory card to another memory card. This allows you to easily reproduce copies without having to copy the files one at a time. Use the following steps:

- 1 Refer to [“To Use a Memory Card” on page 3-36](#) to select the memory card for use.
- 2 Insert the memory card with the files into the front-panel card slot.
- 3 Press **USER**. (If the eye-diagram analyzer personality is loaded, press **USER** twice.)
- 4 Use a keyboard to enter the following Instrument BASIC commands. These commands initialize a RAM disk and copy the files from the card to the RAM disk. If you don't have a keyboard, Instrument BASIC has an editor for creating these commands.

```

INITIALIZE ":MEMORY,0,0"
WILDCARDS DOS
COPY "*" TO ":MEMORY,0,0"

```

- 5 Remove the card from the card slot and insert a blank formatted card in the slot.

Saving to Mass Storage

- 6 Issue the following Instrument BASIC command to copy the files from the RAM disk to the new card:

```
COPY "*:MEMORY,0,0" TO ":EXTERNAL,904"
```

To Catalog all Files

Use this procedure to catalog default memory. To select default memory, refer to [“Selecting and Formatting Memory” on page 3-34](#).

- 1 If you plan to catalog the files on a memory card, insert the card in the front-panel card slot.
- 2 Display a catalog of the files by pressing:

MENU, *page 1 of 2, States, more 1 of 2, mass storage*

Remember to insert the card before cataloging a memory card. If the message "6218 catalog open failed" is displayed, the card is missing. The HP-MSIB address for the card is the same address as the display's GPIB address and is normally set to 4. If the address is not correct, enter the correct address using the numeric keypad.

To Save a File

Use this procedure to save a file in the default memory. To select default memory, refer to [“Selecting and Formatting Memory” on page 3-34](#).

- 1 Display the Mass Storage menu by pressing:

MENU, *page 1 of 2, States, more 1 of 2, mass storage, save*

- 2 Perform one of the following:
 - If you are saving an instrument state, user-correction, or histogram, press the appropriate softkey.
 - If you are saving a trace, press *save trace*. Select the trace and then use the *VEC/FMT* softkey to determine if the trace data is saved as complex data (VEC) or scalar data (FMT). Press save.
 - If you are saving a channel calibration, mask, limit line, user-defined key, all recall registers, press *save misc* and then the appropriate softkey.
- 3 Enter the desired file name.
- 4 To save the file, press:

ENTER LINE

An HP-IL keyboard is recommended to simplify the task of entering alphanumeric information. This keyboard plugs into the jack provided on the display's front panel. Order the Agilent 46021A keyboard.

Entering a File Name without a Keyboard

- a** Turn the front-panel knob to move the character-select cursor.
- b** Press SELECT CHAR to enter a character at the character-select cursor.
- c** Press the numeric keypad to enter numbers or a minus sign.
- d** The INSERT or ... softkey determines the action of the SELECT CHAR softkey. Choices are INSERT a character, REPLACE an existing character, or DELETE a character.
- e** Press the ↑ and ↓ keys (beneath the front-panel knob) to move the command-entry cursor.
- f** Use the CLEAR TO END softkey to remove characters from the command-entry cursor to the end of the command.

To Recall a File

Use this procedure to recall a file from the default memory. To select default memory, refer to [“Selecting and Formatting Memory” on page 3-34](#).

- 1** To recall a file, press:

MENU, *page 1 of 2, States, more 1 of 2, mass storage*

Rotate the front-panel knob to select (highlight) the desired file.

- 2** Load the file by pressing:

LOAD FILE

To Erase a File

Use this procedure to erase a file in the default memory. To select default memory, refer to [“Selecting and Formatting Memory” on page 3-34](#).

- 1** To erase a file, press:

MENU, *page 1 of 2, States, more 1 of 2, mass storage*

Rotate the front-panel knob to select (highlight) the desired file.

- 2** To erase the file, press:

more, PURGE FILE, ENTER LINE

To Erase all Files

CAUTION

This procedure erases all files stored in default memory.

To erase *all* files in default memory, press:

MENU, *page 1 of 2, States, more 1 of 2, mass storage, more, FORMAT*

To Change the Prefix

- 1** To modify the prefix, press:

MENU, *page 1 of 2, States, more 1 of 2, mass storage, more, CHANGE PREFIX*

Enter the desired text.

- 2** To enter the prefix, press:

ENTER LINE

Entering the prefix without a keyboard

- a** Turn the front-panel knob to move the character-select cursor.
 - b** Press SELECT CHAR to enter a character at the character-select cursor.
 - c** Press the numeric keypad to enter numbers or a minus sign.
 - d** The INSERT or ... softkey determines the action of the SELECT CHAR softkey. Choices are INSERT a character, REPLACE an existing character, or DELETE a character.
 - e** Press the ↑ and ↓ keys (beneath the front-panel knob) to move the command-entry cursor.
 - f** Use the CLEAR TO END softkey to remove characters from the command-entry cursor to the end of the command.
-

To Erase a Custom Prefix

- 1 To erase a custom prefix, press:

MENU, page 1 of 2, States, more 1 of 2, mass storage, more, CHANGE PREFIX

Repeatedly press the ↓ step key until the cursor is located at the start of the custom text.

- 2 Clear the text by pressing:

CLEAR TO END, ENTER LINE

To Save an Instrument State

- 1 Set the eye-diagram analyzer to the desired settings.
- 2 Insert a ROM card into the front-panel card slot.
- 3 Save the instrument state by pressing:

Mass Storage, SAVE STATE

To Load a State or Mask/Limit Line

- 1 Insert a ROM card into the front-panel card slot and then press:

Mass Storage

Rotate the front-panel knob to highlight the desired file.

The prefix "S_" identifies instrument state files.

The prefix "M_" identifies mask/limit line files.

- 2 Load the file by pressing:

LOAD FILE

**To Save a Mask/
Limit Line File**

- 1 Display the Mass Storage menu by pressing:

States, more 1 of 2, mass storage

If the mass-storage device needs to be selected, refer to [“Selecting and Formatting Memory” on page 3-34](#).

- 2 Enter the file name by pressing:

save, save misc, SAV MSK LIM

Use the softkeys, knob, numeric keypad, and step keys to enter the file name.

- 3 Save the file by pressing:

ENTER LINE

**To Recall a Mask/
Limit Line File**

- 1 To recall a mask/limit line file, press:

MENU, *page 1 of 2, States, more 1 of 2, mass storage*

If the mass-storage device needs to be selected, refer to [“Selecting and Formatting Memory” on page 3-34](#).

- 2 Rotate the front-panel knob to select (highlight) the desired file.

- 3 Load the file by pressing:

LOAD FILE

**To Erase a Mask
File/Limit Line
File**

- 1 To erase a mask/limit line file, press:

MENU, *page 1 of 2, States, more 1 of 2, mass storage*

If the mass-storage device needs to be selected, refer to [“Selecting and Formatting Memory” on page 3-34](#).

- 2 Rotate the front-panel knob to select (highlight) the desired file.

- 3 Erase the file by pressing:

more, PURGE FILE

Creating Copies of the Display

Often, it is important to create hard copies of the display for reports or records. A copy of the display can be printed on any Hewlett-Packard graphics printer. These printers support the Hewlett-Packard PCL printer language and include the following:

- ThinkJet
- PaintJet
- LaserJet

Note

The printer must have an GPIB interface.

Hard copies can be produced on a Hewlett-Packard plotter if the eye-diagram analyzer is in pattern mode. Plots cannot be produced in eye or eyeline modes.

To Create a Print

- 1 Connect the printer to the display via an GPIB cable.

Be sure to connect the GPIB to the display's connector, not to the connector on the 70820A microwave transition analyzer module.

- 2 The first time the printer is used, enter the printer type and address by pressing:

DISPLAY, *Hard Copy*, *printer address*

GPIB TLK/LSN to configure the printer in talk/listen mode on the GPIB.

GPIB L ONLY to configure the printer in listen only mode on the GPIB.

To configure the printer via the HP-MSIB, use the HP-MSIB COLUMN and HP-MSIB ROW softkeys to enter the printer address.

- 3 To select the type of printer used, press:

←, *printer config*

Use the softkeys along the right side of the display to select the printer type.

- 4 Select the print option by pressing:
*←, copy options, COPY IS PRT/PLT*PRT
- 5 Create the print by pressing:
USER, PRINT

To Create a Plot Hard copies can be produced on an Hewlett-Packard plotter if the eye-diagram analyzer is in pattern mode. Plots cannot be produced in eye or eyeline modes.

- 1 Connect the plotter to the display via an GPIB cable.
Be sure to connect the GPIB to the display's connector, not to the connector on the 70820A microwave transition analyzer module.
 - 2 The first time the plotter is used, enter the plotter type and address by pressing:
DISPLAY, *Hard Copy, plotter address*
HP-IB TLK/LSN to configure the plotter in talk/listen mode on the GPIB.
HP-IB L ONLY to configure the plotter in listen only mode on the GPIB.
To configure the plotter via the HP-MSIB, use the HP-MSIB COLUMN and HP-MSIB ROW softkeys to enter the plotter address.
 - 3 To select the type of plotter used, press:
←, plotter config
Use the softkeys along the right side of the display to select the plotter type.
 - 4 Select the plotter option by pressing:
*←, copy options, COPY IS PRT/PLT*PLT
 - 5 Create the plot by pressing:
USER, PLOT
-

Agilent 70820A User-Corrections

User corrections provide a convenient method for modifying the display of input signals. Some of the applications for user-corrections include the following:

- Filtering input signals to simulate the effects of circuit design.
- Compensating for frequency and phase response of external probes.
- Compensating for frequency and phase response of external test setups.
- Compensating for the frequency response of optical to electrical converters.

To create and use your own user-corrections, enter the User Correction menu. (This menu is located under the 70820A's Calib menu.) The microwave transition analyzer maintains two separate user-correction memories: one for channel 1 and one for channel 2. After entering the User Correction menu, the microwave transition analyzer displays user-correction data in the lower half of the screen. The screen's upper half remains dedicated to showing the normal display. Or, if the displayed trace is assigned to the data, the trace shows a graphical representation of the filter, as the following figure shows. To learn how to assign a trace to user-corrections, refer to [“Viewing User-Correction Data” on page 3-56](#).

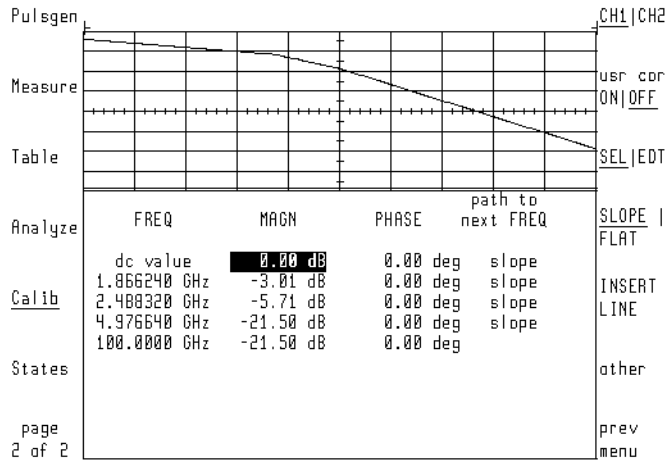

Example User-Corrections

User corrections always contain at least two default lines of data, as shown in the following figure. While these two lines of data cannot be removed, you can modify their magnitude or phase values. New lines of data are easily added. Each line of data consists of FREQUENCY, MAGNITUDE, PHASE, and path to next FREQUENCY fields. The path to next FREQUENCY field determines how data is interpolated between two adjacent user-correction frequency points. The path to the next user-correction point can be a linear slope (this is the default), log slope, or flat line.

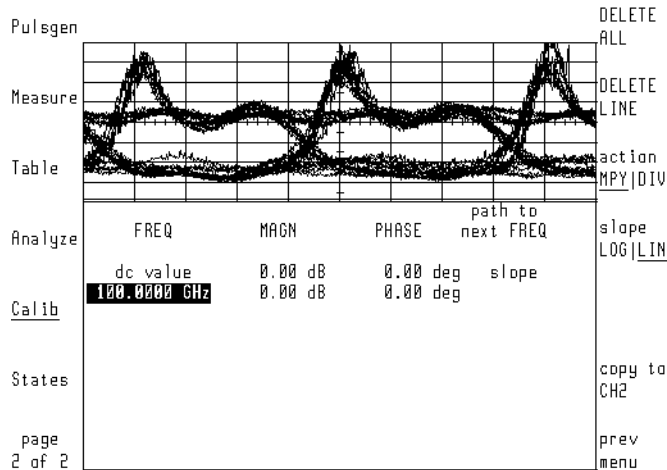

Default Data

Enter user-correction data by: manually using front-panel keys or storing the results of a sweep to user-correction memory.

To Enter the User Correction Menu

Display the User Correction menu by pressing:

MENU, page 1 of 2, Calib, user corr

To Select a Channel for User-Corrections

Select a channel for user-corrections by pressing:

MENU, page 1 of 2, Calib, user corr

CH1/CH2 CH1 to select channel 1

CH1/CH2 CH2 to select channel 2

To Turn User-Corrections On and Off

User correction can be turned on and off using either the Menu softkeys or the User softkeys.

- Use the Menu softkeys to turn user-corrections on and off by pressing:
MENU, page 1 of 2, Calib, user corr, usr cor ON/OFF
- Use the User softkeys to turn user-corrections on and off by pressing:
USER, Trg, Cal, more 1 of 2, usr cor ON/OFF

To Delete a Channel's User-Corrections

- 1 Delete a channel's user-corrections by pressing:
MENU, page 1 of 2, Calib, user corr
- 2 Select the desired channel by pressing:
CH1/CH2
- 3 Delete the selected channels user-corrections by pressing:
other, DELETE ALL
- 4 To delete all corrections, press:
CONFIRM DEL ALL
- 5 To cancel the deletion process, press:
ABORT DEL ALL

Entering and Editing User-Corrections

The User Correction menu provides softkeys for entering and editing lines of user-correction data. To view user-correction data graphically at the same time it is created, refer to ["Viewing User-Correction Data" on page 3-56](#).

The *SEL/EDT* softkey determines whether the front-panel knob and arrow keys select a field for editing the current field's data. New lines can be entered between the first and last lines. Refer to "To enter a line of data" in this section.

The microwave transition analyzer interpolates the data between adjacent points. Interpolation between the defined points can be either slope or flat line. If slope is selected, the *slope LOG/LIN* softkey determines whether slopes are linear or logarithmic. To locate this softkey, press *other* in the User Correction menu.

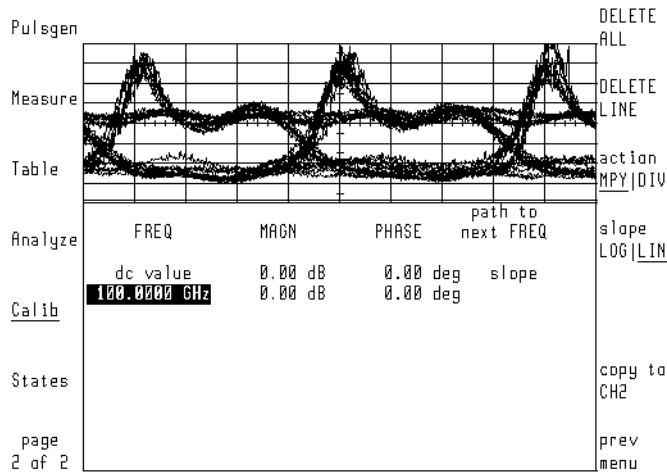

The following two figures show the effect of selecting linear slope and flat types. The trace graphically shows the filter. With the exception of the path to next FREQ field, the data in each filter is identical.

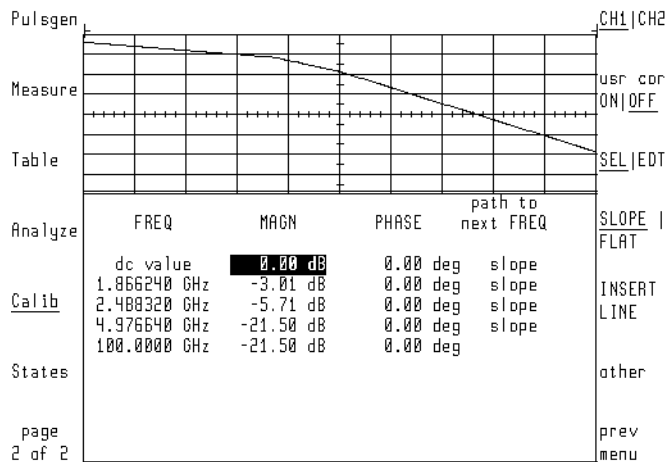

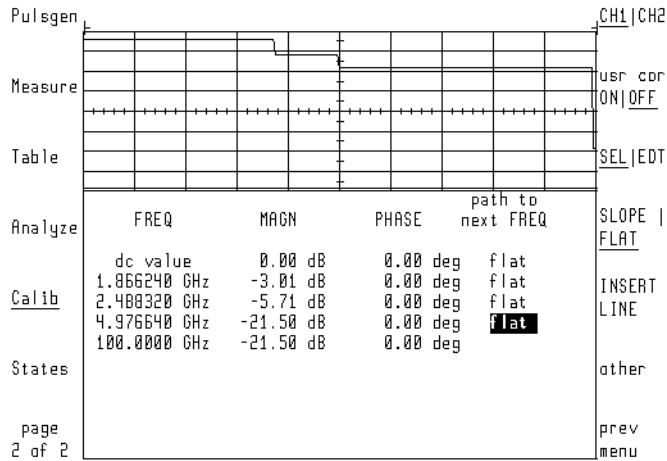

To Enter a Line of Data

- 1 Enter a line of data by pressing:

MENU, page 1 of 2, Calib, user corr, SEL/EDT SEL

New lines are added just above the highlighted line. Use the front-panel knob or arrow keys to highlight any field of the line which is to be below the new inserted line.

- 2 Insert the line by pressing:

INSERT LINE

To Edit a Line of Data

- 1 To edit a line of data, press:

MENU, page 1 of 2, Calib, user corr, SEL/EDT EDT

Use the front-panel knob, step keys, or numeric keypad to change the displayed value.

- 2 If you are editing the path to next **FREQ** field, change the value by pressing:

SLOPE/ FLAT

To Delete a Line of Data

- 1 Select the line of data to be deleted by pressing:

MENU, page 1 of 2, Calib, user corr, SEL/EDT **SEL**

Use the front-panel knob or arrow keys to highlight any field in the line you wish to delete.

- 2 Delete the highlighted text by pressing:

other, **DELETE LINE**

To Select Flat-Line Interpolation

- 1 Highlight the desired field by pressing:

MENU, page 1 of 2, Calib, user corr, SEL/EDT SEL

Use the front-panel knob or arrow keys to highlight the desired path to next **FREQ** field.

- 2 Select flat-line interpolation by pressing:

SLOPE/ FLAT FLAT

To Select Logarithmic Slope Interpolation

Select logarithmic slope interpolation by pressing:

MENU, page 1 of 2, Calib, user corr, other, slope **LOG/LIN** LOG

For logarithmic interpolation to take effect, the path to next **FREQ** field in the lines of data must be set to slope.

To Copy User-Correction to Alternate Channel

Copy user correction to an alternate channel by pressing:

MENU, *page 1 of 2, Calib, user corr, other, copy to CH2*

If channel 2 data is selected, the softkey reads *copy to CH1*.

Viewing User-Correction Data

This section explains how to assign user-correction data to a trace. This allows you to view the data graphically. Graphically displaying the data is especially helpful when you are designing a custom filter. When a trace is assigned to user correction data, the display's horizontal axis automatically changes to frequency. The technique used to control the frequency scale depends on the microwave transition analyzer's sweep mode.

Set the Frequency Scale for Frequency Sweeps

When using a frequency sweep, the frequency scales of the microwave transition analyzer and the user-correction trace are identical. The start and stop frequencies are the same. This includes any frequency offset.

Set the Frequency Scale for Time Sweeps

When the microwave transition analyzer is performing time sweeps, the frequency scale of any user-correction trace is related to the sweep time. The start frequency is set to 0 Hz. The stop frequency is determined by the seconds-per-division setting. To set the stop frequency, use the following formula to determine the seconds-per-division setting, then set the sweep time using the Main menu's SEC/DIV softkey.

$$\text{seconds/division} = \frac{\text{trace length}}{20 F_{\text{stop}}}$$

where:

trace length is determined by pressing TRACE POINTS in the Configuration menu.

F_{stop} equals the desired stop frequency in hertz.

For example, to set the stop frequency to 5 GHz with 512 trace points, set the time scale to 5.12 ns per division.

This formula also determines the frequency scale of any time domain trace that has been formatted to the frequency domain using an FFT. The advantage of using a trace formatted using an FFT is that the displayed upper frequency limit can be higher than the available range of many RF sources.

To View User-Corrections

- 1 To view user-corrections, press:

MENU

- 2 To enter the Traces menu, press:

Traces

- 3 Select a trace, and then press:

input:

- 4 Use the front-panel knob to scroll the menu bar to *UCORR1*, as shown in the following figure.

UCORR1 sets the trace to user-correction data for channel 1.

UCORR2 sets the trace to user-correction data for channel 2.

Main	TR1 = UCORR1	CH1
Trigger	CH1 2 = CH2 3,4 = CH1/CH2	CH2
<u>Traces</u>	CH2/CH1 CH1/MEM1 CH2/MEM2 TABLE	CH1/CH2
Scale	1 = UCORR1 UCORR2 (CH1/CH2)/MEM1 -(CH1/CH2)/MEM3	CH2/CH1
Markers	2*MAGN(CH1/CH2)/(MAGN(MEM2)+MAGN(MEM3))	MEMx
Config		build eqn
page 1 of 2		RETURN

- 5 Press the *RETURN* softkey.
- 6 To enter the Main menu, press:

Main

7 Set the frequency scale of the user-correction trace:

- If the microwave transition analyzer is set for a frequency sweep, use the Main menu's *START* and *STOP* softkeys.
- If the microwave transition analyzer is set for a time sweep, press the Main menu's *SEC/DIV* softkey, and enter the sweep time to set the stop frequency. The formula to determine the sweep time is provided at the beginning of this section.

8 To enter the Scale menu, press:

Scale

9 Press the **REF LEV|POS** softkey, and set the reference level to correctly position the trace on screen.

10 Change the vertical amplitude scale, if needed, by pressing:

SCALE, Calib, user corr

The user correction data is now displayed graphically above the data.

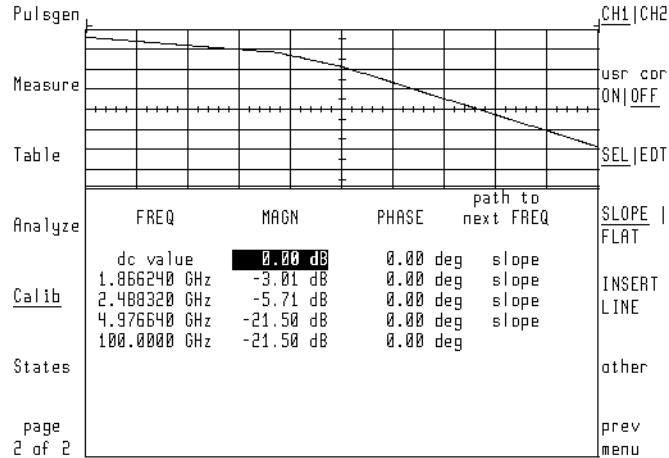

Saving, Recalling, and Cataloging User-Correction Files

User-correction data can be saved in files and recalled for later use. This section shows you how to accomplish this task using the 70820A module's *mass storage* menu. (You can also save, recall, and erase user-correction files using the eye-diagram analyzer's *Mass Storage* menu.)

The files are saved to default memory. To select default memory, refer to [“Selecting and Formatting Memory” on page 3-34](#). Each file has a file name that consists of the prefix *a_* followed by a custom name that you enter. The prefix identifies the file as user-correction data.

Entering file names is made much easier if you have an 46021A keyboard and keyboard cable.

To Save a User-Correction File

- 1 Display the Mass Storage menu by pressing:

MENU, page 1 of 2, States, more 1 of 2, mass storage

If the mass-storage device needs to be selected, refer to [“Selecting and Formatting Memory” on page 3-34](#).

- 2 Save the user-correction file by pressing:

save, *SAVE USR COR*

Entering a File Name without a Keyboard

- a Turn the front-panel knob to move the character-select cursor.
- b Press *SELECT CHAR* to enter a character at the character-select cursor.
- c Press the numeric keypad to enter numbers or a minus sign.
- d The *INSERT* or ... softkey determines the action of the *SELECT CHAR* softkey. Choices are *INSERT* a character, *REPLACE* an existing character, or *DELETE* a character.
- e Press the ↓ and ↑ keys (beneath the front-panel knob) to move the command-entry cursor.
- f Use the *CLEAR TO END* softkey to remove characters from the command-entry cursor to the end of the command.

To Recall a User-Correction File

- 1 To recall a user-correction file, press:

MENU, *page 1 of 2, States, more 1 of 2, mass storage*

If the mass-storage device needs to be selected, refer to [“Selecting and Formatting Memory” on page 3-34](#).

- 2 Rotate the front-panel knob to select (highlight) the desired file.
- 3 Load the file by pressing:

LOAD FILE

To Erase a User-Correction File

- 1 To erase a mask/limit line file, press:

MENU, *page 1 of 2, States, more 1 of 2, mass storage*

If the mass-storage device needs to be selected, refer to [“Selecting and Formatting Memory” on page 3-34](#).

- 2 Rotate the front-panel knob to select (highlight) the desired file.
- 3 Erase the file by pressing:

more, PURGE FILE

Agilent 70820A Calibration

Use the Calibration menu to perform the following tasks:

- Match delay between channels.
- Initiate an instrument self-test routine.
- Turn off RF correction.
- Calibrate the IF.
- Verify the calibrator signal.

The Calibration Menu

The automatic IF calibrations documented in this section ensure accurate measurements using the eye-diagram analyzer. RF correction data resides in nonvolatile instrument memory and does not need to be changed unless repairs have been made. The Calibration Menu's user corr softkey features are documented in [“Agilent 70820A User-Corrections”](#) on page 3-49.

Agilent 70820A Calibration

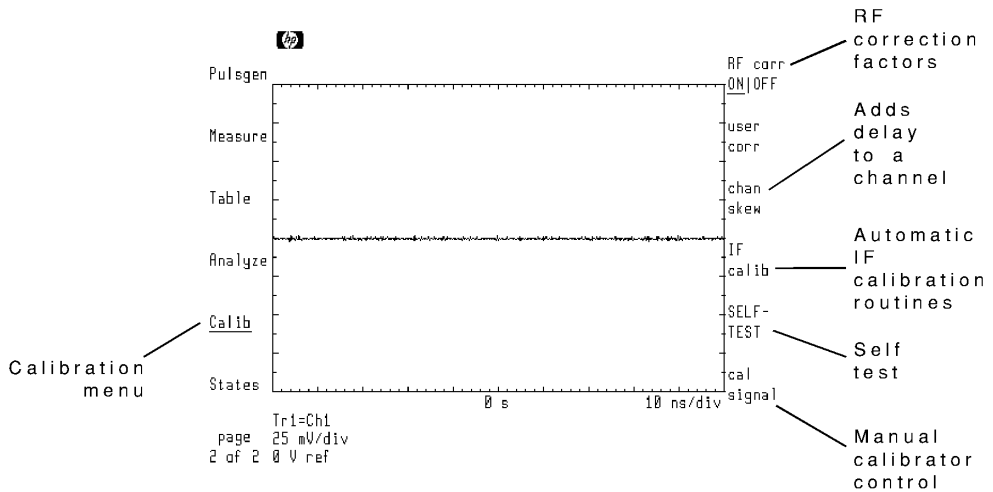

The Calibration Menu

Turning Off RF Correction

The microwave transition analyzer module applies RF correction factors to all measurements. These correction factors are loaded into nonvolatile memory at the factory . You can prevent the use of RF correction factors during measurements.

Note Eyeline and pattern modes are required. RF corrections can only be applied in eyeline and pattern modes. RF corrections must be off in eye mode.

To Turn Off RF Correction

Turn off RF correction by pressing:
MENU, page 1 of 2, Calib, RF corr ON/OFF OFF

Matching Delay Between Channels

Significant delays can occur between the signals on channel 1 and channel 2 when the electrical lengths of external cabling varies. This results in a phase offset between the two channels. The microwave transition analyzer module offers the capability to add delay to either channel 1 or channel 2.

The following figure shows added delay on channel 2.

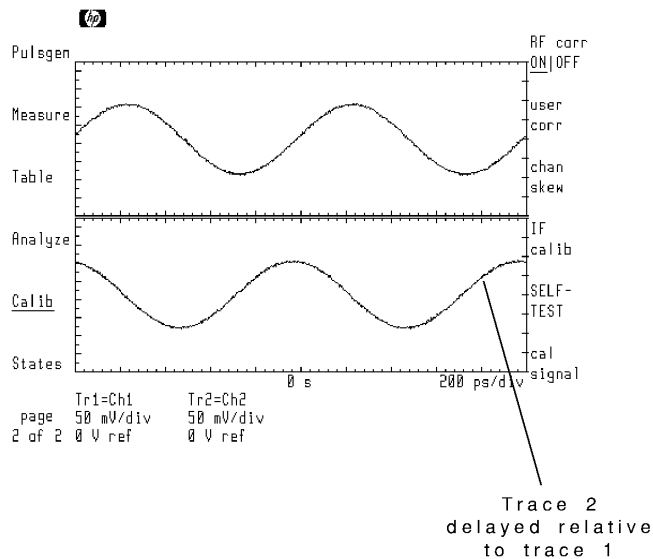

Use the AUTO SKEW softkey to automatically compensate the delay on channel 2. Automatic skewing assumes two equal phase signals input to channels 1 and 2. If measurements are to be performed at multiple frequencies, it is recommended that the AUTO SKEW function be performed first at a low frequency and then at higher frequencies to ensure better resolution.

Delay can be manually compensated using the CHAN2 SKEW softkey. For convenience, the SEC/DIV softkey is provided so that the time scale can be changed.

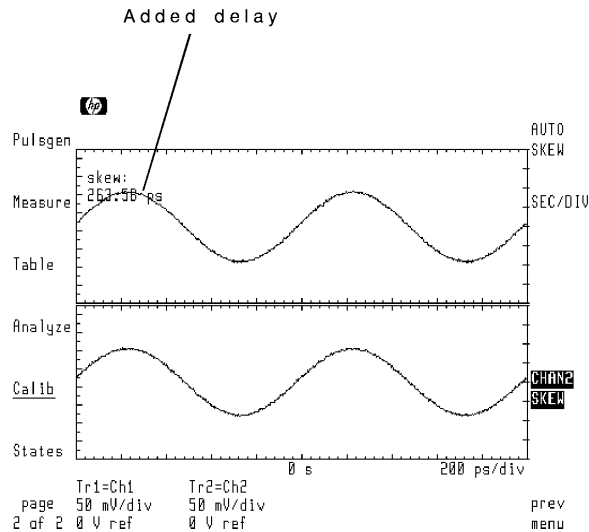

Trace 2 Delay Compensated

To Delay a Channel

Automatically compensate channel 2 by pressing:

MENU, *page 1 of 2, Calib, chan skew, AUTO SKEW*

Calibrating the IF

The microwave transition analyzer module provides separate automatic IF calibration routines for channel 1 and channel 2. Each requires approximately 30 minutes to run. For optimum performance, you should perform the calibrations when at least one of the following is true:

- The temperature has changed $\pm 5^\circ$ Centigrade since the last calibration was performed.
 - More than one week has passed since the last calibration.
 - Before any critical measurement.
-

Note Warm up time Allow the microwave transition analyzer module to warm up for at least one hour before performing a calibration.

To Calibrate the IF

- 1 Connect a low-loss cable between the front-panel CALIBRATOR OUTPUT and channel 1 connectors.
- 2 To calibrate the IF, press:
MENU, *page 1 of 2, Calib, IF calib, CAL CH1, CAL CH1*
The calibration routine takes about 30 minutes to complete.
- 3 Disconnect the cable from channel 1, and connect it to the channel 2 connector.
- 4 Repeat the above procedure for channel 2.

To View the Last Calibration Date

- 1 Turn any displayed traces off to make viewing the calibration date easier.
- 2 Continue by pressing:
MENU, *page 1 of 2, Calib, IF calib, cal debug, show*
- 3 To view when channel 1 was last calibrated, press:
CH1 CAL INFO
- 4 To view when channel 2 was last calibrated, press:
CH2 CAL INFO

Viewing the Calibration Data

The ability to view the IF calibration data is mainly intended for service purposes. However, the procedures in this section show you how to view the data.

To View IF Correction Data Traces

- 1 Display the Traces menu by pressing:
MENU, Traces
 - 2 Turn on both trace 1 and trace 2. Set the input to trace 1 as channel 1. Set the input to trace 2 to channel 2.
 - 3 Display the IF correction data for each channel by pressing:
*page 1 of 2, Calib, IF calib, cal debug, show ,
SHOW COR FFT or SHOW COR FIR*
 - 4 Scale the traces by pressing:
page 2 of 2, Scale
 - 5 Select trace 1, and press:
AUTOSCALE
 - 6 Select trace 2, and press:
AUTOSCALE
-

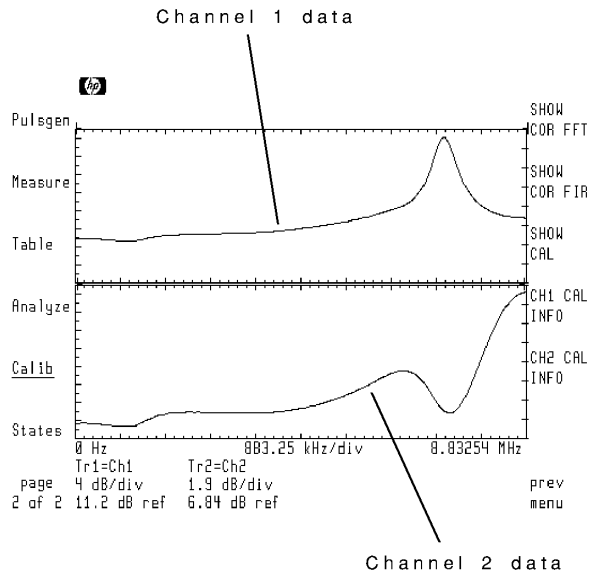

To View Hardware Response Traces

- 1 Display the traces menu by pressing:
MENU, Traces
- 2 Turn on both trace 1 and trace 2. Set the input to trace 1 as channel 1. Set the input to trace 2 to channel 2.
- 3 Display the 100 kHz filter response of stage 0 by pressing:
page 1 of 2, Calib, IF calib, cal debug, show, SHOW CAL
- 4 Scale the traces by pressing:
page 2 of 2, Scale
- 5 Select trace 1, and press:
AUTOSCALE
- 6 Select trace 2, and press:
AUTOSCALE

- 7 To display the various hardware responses, press:

page 1 of 2, SHOW CAL

Use the front-panel step keys to scroll through the various hardware responses.

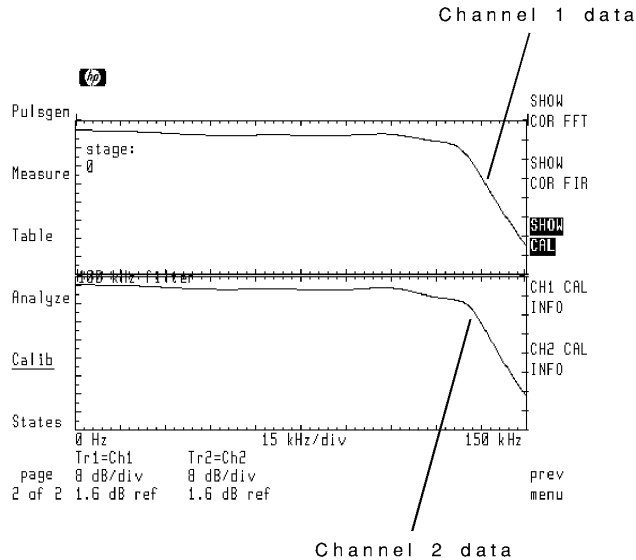

To View Calibration Data

- 1 Display the Traces menu by pressing:
MENU, Traces
 - 2 To make viewing the calibration date easier, turn all displayed traces off by pressing:
select: , display ON OFF OFF
 - 3 Display the Calibration menu by pressing:
page 1 of 2, Calib
 - 4 To view the data, press:
IF calib, cal debug, show
-

- 5 To view the data for channel 1, press:
CH1 CAL INFO
- 6 To view the data for channel 2, press:
CH2 CAL INFO
- 7 To view additional pages of information, continue pressing:
CH1 CAL INFO or *CH2 CAL INFO*

Performing a Self-Test

You can initiate an automatic self-test routine that checks the internal condition of all major circuits. The self-test takes approximately 30 seconds to run. (This routine automatically runs whenever the microwave transition analyzer is turned on.)

Perform the self-test by pressing:

MENU, *page 1 of 2, Calib, SELF-TEST*

Controlling the Calibrator Signal

For verification purposes, the Calibrator Output signal can be manually controlled. This includes changing its amplitude and frequency. The signal has the following characteristics:

Shape	square wave
Frequency	153 Hz to 5 MHz
Amplitude	5 positions

The signal's amplitude can be set to one of five positions: 0 through 4. Zero represents the smallest available amplitude. Four represents the largest amplitude. These settings do not correlate to any specific amplitude and may vary between instruments.

Agilent 70820A Calibration

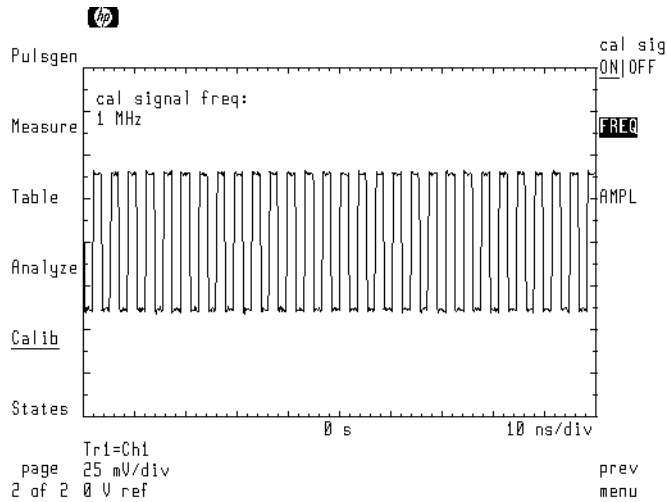

**To Turn the
Calibrator Signal
On**

To turn the calibrator signal on, press:

MENU, *page 1 of 2*, *Calib*, *cal signal*, *cal sig ON/OFF* ON

**To Change the
Calibrator
Frequency and
Amplitude**

To change the calibrator frequency and amplitude, press:

MENU, *Calib*, *cal signal*, *FREQ*, (156 Hz–5 MHz), *AMPL*, (0–4)

Programming Commands

Programming Commands

This chapter documents programming the eye-diagram analyzer.

Note

You will find the preview feature discussed in this chapter very useful. It displays the programming command corresponding to the response received when most softkeys are pressed.

You will find information on the following commands in this chapter.

- [ALIGN](#) 4-4
 - [BIT](#) 4-5
 - [CLEAR](#) 4-5
 - [DEFAULT](#) 4-6
 - [DELAY](#) 4-7
 - [DIAGRAM](#) 4-7
 - [EXTIN](#) 4-8
 - [MARGIN](#) 4-9
 - [MARMSK](#) 4-9
 - [MEAS](#) 4-10
 - [PERSIST](#) 4-11
 - [QUIT](#) 4-12
-

Introduction

Before communicating with the eye-diagram analyzer application, the Instrument BASIC system must be queried for the name of the program and told we wish to communicate with this program. The following example shows how to do this.

```
OUTPUT Mta;"PROG:CAT?"           !Request list of currently loaded programs
ENTER Mta;Name$                 !There can only be one at present
OUTPUT Mta;"PROG:NAME ";Name$   !Send program name
```

Use Variables to Pass Commands and Data

Because the 70874A is an Instrument BASIC program, normal programming techniques are not employed. Instead, program control is achieved through manipulating three 70874C program variables: Command, Param, and Response. Strings and numbers are passed to these variables via two microwave transition analyzer commands:

```
PROG:STRing
PROG:NUMBer
```

The Command string variable directs the 70874C to perform an action. Twelve possible command strings are documented in this chapter: ALIGN, BIT, CLEAR, DEFAULT, DELAY, DIAGRAM, EXTIN, MARGIN, MARMSK, MEAS, PERSIST, QUIT.

Load the Param variable with a parameter for the selected Command variable string. Because execution begins immediately after Command is loaded, load Param before Command. Param is actually two variables with the same name; one is a string variable, the other is a numeric variable.

After execution of a command, the Response string variable contains any resulting query data. The following program shows how to turn on infinite persistence. Notice how the Param variable is loaded before the Command variable.

```
OUTPUT Mta;"PROG:STR 'Param','INF"
OUTPUT Mta;"PROG:STR 'Command','PERSIST"
```

Use PROG:STR? to Read Response

The 70874A pauses execution after completion of each command. This provides a mechanism for synchronization between the issuance of a command and the retrieval of a response. In your controlling program, use the

Introduction

PROG:WAIT? query to indicate when the 70874C has paused. Then, retrieve the response using the PROG:STR? query. Use PROG:STATE to continue program execution. (Notice the lower case letter e in PROG:STATE. This indicates the this letter can be entered in either upper or lower case.)

The following example shows how to return the results of eye measurement. Notice that the MEAS command does not use the Param variable.

```
OUTPUT Mta;"PROG:STR 'Command';MEAS"
OUTPUT Mta;"PROG:WAIT?"
ENTER Mta;A$
OUTPUT Mta;"PROG:STR? 'Response'"
ENTER Mta;Response$
OUTPUT Mta;"PROG:STAT CONT"
```

ALIGN

The ALIGN command string automatically aligns a mask to the eye.

Values of Program Variables

Variable	Data Type	Value
Command	string	ALIGN
Param	<i>There are no parameters for this command.</i>	
Response	string	DONE

Example

```
OUTPUT Mta;"PROG:STR 'Command';ALIGN"
OUTPUT Mta;"PROG:WAIT?"
ENTER Mta;A$
OUTPUT Mta;"PROG:STR? 'Response'"
ENTER Mta;Response$
OUTPUT Mta;"PROG:STAT CONT"
```

BIT

The BIT command string sets the instrument's time scale (seconds-per-division) to a value which corresponds to the number of bits specified in the Param variable.

Values of Program Variables

Variable	Data Type	Value
Command	string	BIT
Param	floating-point number	example: 3.5
Response	string	DONE

Example

```
OUTPUT Mta;"PROG:NUMB 'Param',3.5"
OUTPUT Mta;"PROG:STR 'Command','BIT'"
OUTPUT Mta;"PROG:WAIT?"
ENTER Mta:A$
OUTPUT Mta;"PROG:STR? 'Response'"
ENTER Mta:Response$
OUTPUT Mta;"PROG:STAT CONT"
```

CLEAR

The CLEAR command string clears the display for persistence mode or error-trace mode. CLEAR also restarts any trace averaging.

Values of Program Variables

Variable	Data Type	Value
Command	string	CLEAR
Param	<i>There are no parameters for this command.</i>	
Response	string	DONE

Introduction

Example

```
OUTPUT Mta;"PROG:STR 'Command','CLEAR'"
OUTPUT Mta;"PROG:WAIT?"
ENTER Mta:A$
OUTPUT Mta;"PROG:STR? 'Response'"
ENTER Mta:Response$
OUTPUT Mta;"PROG:STAT CONT"
```

DEFAULT

The DEFAULT command string copies the default masks specified in the Param variable. Select a mask from the following types:

- STM-1:** default mask for STM-1
- STM-4:** default mask for STM-4
- STM-16:** default mask for STM-16
- OC-3:** default mask for OC-3
- OC-12:** default mask for OC-12
- OC-48:** default mask for OC-48

Values of Program Variables

Variable	Data Type	Value
Command	string	DEFAULT
	string	STM-1 STM-4 STM-16
Param		OC-3
		OC-12
		OC-48
Response	string	DONE

Example

```
OUTPUT Mta;"PROG:STR 'Param','STM-4'"
OUTPUT Mta;"PROG:STR 'Command','DEFAULT'"
OUTPUT Mta;"PROG:WAIT?"
ENTER Mta:A$
OUTPUT Mta;"PROG:STR? 'Response'"
ENTER Mta:Response$
OUTPUT Mta;"PROG:STAT CONT"
```

DELAY

The DELAY command string sets the displayed delay value to the number of bits specified in the Param variable.

Values of Program Variables

Variable	Data Type	Value
Command	string	DELAY
Param	floating-point number	example: 2.75
Response	string	DONE

Example

```
OUTPUT Mta;"PROG:NUMB 'Param',2.75"
OUTPUT Mta;"PROG:STR 'Command','DELAY'"
OUTPUT Mta;"PROG:WAIT?"
ENTER Mta:A$
OUTPUT Mta;"PROG:STR? 'Response'"
ENTER Mta:Response$
OUTPUT Mta;"PROG:STAT CONT"
```

DIAGRAM

The DIAGRAM command string sets the diagram display to one of the following types specified in the Param variable:

EYE: displays eye pattern. This is the standard display shown on digitizing oscilloscopes.

EYELINE: displays a continuous line which shows the actual data value for the bit period.

PATTERN: displays a continuous line like EYELINE, but for pattern trigger mode.

Introduction**Values of Program Variables**

Variable	Data Type	Value
Command	string	DIAGRAM
Param	string	EYE EYELINE PATTERN
Response	string	DONE

Example

```

OUTPUT Mta;"PROG:STR 'Param','EYELINE"
OUTPUT Mta;"PROG:STR 'Command','DIAGRAM"
OUTPUT Mta;"PROG:WAIT?"
ENTER Mta;A$
OUTPUT Mta;"PROG:STR? 'Response'"
ENTER Mta;Response$
OUTPUT Mta;"PROG:STAT CONT"

```

EXTIN

The EXTIN command string performs an extinction ratio measurement. The Response variable is loaded with two floating-point numbers. The first number is the linear ratio. The second number is the logarithmic value.

Values of Program Variables

Variable	Data Type	Value
Command	string	EXTIN
Param	<i>There are no parameters for this command.</i>	
Response	string	<i>Two floating-point numbers.</i>

Example

```

OUTPUT Mta;"PROG:STR 'Command';'EXTIN'"
OUTPUT Mta;"PROG:WAIT?"
ENTER Mta:A$
OUTPUT Mta;"PROG:STR? 'Response'"
ENTER Mta:Response$
OUTPUT Mta;"PROG:STAT CONT"

```

MARGIN

The MARGIN command string sets the margin percentage limit for margin mask testing. Load the Param variable with a floating-point number that specifies the percentage over standard mask to test. The range of margin is 0 to 100 percent.

Values of Program Variables

Variable	Data Type	Value
Command	string	MARGIN
Param	floating-point number	0 to 100% (example: 25.6)
Response	string	DONE

Example

```

OUTPUT Mta;"PROG:NUMB 'Param',25.6"
OUTPUT Mta;"PROG:STR 'Command';'MARGIN'"
OUTPUT Mta;"PROG:WAIT?"
ENTER Mta:A$
OUTPUT Mta;"PROG:STR? 'Response'"
ENTER Mta:Response$
OUTPUT Mta;"PROG:STAT CONT"

```

MARMSK

The MARMSK command string turns on or off margin mask testing.

Introduction**Values of Program Variables**

Variable	Data Type	Value
Command	string	MARMSK
Param	string	ON OFF
Response	string	DONE

Example

```

OUTPUT Mta;"PROG:STR 'Param','ON"
OUTPUT Mta;"PROG:STR 'Command','MARMSK"
OUTPUT Mta;"PROG:WAIT?"
ENTER Mta:A$
OUTPUT Mta;"PROG:STR? 'Response'"
ENTER Mta:Response$
OUTPUT Mta;"PROG:STAT CONT"

```

MEAS

The MEAS command string performs the following eight measurements on the eye:

- 1** mean 1 level
- 2** mean 0 level
- 3** eye height
- 4** crossing level
- 5** eye width
- 6** eye jitter
- 7** mean rise time
- 8** mean fall time

The Response variable is loaded with eight floating-point numbers. Each number is the result of one of the eight measurements. The numbers are ordered according to the list shown above.

Values of Program Variables

Variable	Data Type	Value
Command	string	MEAS
Param	<i>There are no parameters for this command.</i>	
Response	string	example: 25.1 14.2 9.67 2.23 8.91 4.5 2.11 6.7

Example

```

OUTPUT Mta;"PROG:STR 'Command','MEAS'"
OUTPUT Mta;"PROG:WAIT?"
ENTER Mta:A$
OUTPUT Mta;"PROG:STR? 'Response'"
ENTER Mta:Response$
OUTPUT Mta;"PROG:STAT CONT"

```

PERSIST

The PERSIST command string controls persistence displays. Persistence modes are available through the standard microwave transition analyzer remote commands, however, special color maps are necessary for proper display and are available only with Instrument BASIC.

Command parameters include INF, VAR, COLGRAD, MONOGRAD, and OFF. Each parameter has the following action:

- INF turns on infinite persistence mode.
- VAR turns on variable persistence mode.
- COLGRAD turns color graded persistence mode.
- MONOGRAD turns monochrome graded persistence mode.
- OFF turns persistence mode off.

Introduction**Values of Program Variables**

Variable	Data Type	Value
Command	string	PRESIST
	string	INF VAR COLGRAD MONOGRAD OFF
Param		
Response	string	DONE

Example

```

OUTPUT Mta;"PROG:STR 'Param','COLGRAD"
OUTPUT Mta;"PROG:STR 'Command','PERSIST"
OUTPUT Mta;"PROG:WAIT?"
ENTER Mta:A$
OUTPUT Mta;"PROG:STR? 'Response'"
ENTER Mta;Response$
OUTPUT Mta;"PROG:STAT CONT"

```

QUIT

The QUIT command string causes the eye-diagram personality to terminate. This command does not pause upon completion.

Values of Program Variables

Variable	Data Type	Value
Command	string	QUIT
Param	<i>There are no parameters for this command.</i>	
Response	<i>There is no response from this command.</i>	

Example

```

OUTPUT Mta;"PROG:STR 'Command','QUIT"

```

Specifications and Characteristics

Specifications and Characteristics

This chapter contains specifications and characteristics for the 71501C and 70874C Jitter and Eye Diagram Analyzer.

Definitions of Terms

The distinction between specifications, *characteristics*, typical performance, and nominal values is described as follows:

- Specifications describe warranted performance over the temperature range 0°C to +55°C (unless otherwise noted). All specifications apply after the instrument's temperature has been stabilized after 1 hour continuous operation and self-calibration routines have been run. Unless otherwise noted, corrected limits are given when specifications are subject to minimization with error-correction routines.
 - *Characteristics* provide useful, but nonwarranted information about the functions and performance of the instrument. *Characteristics are printed in italics.*
 - Typical Performance, where listed, is not *warranted*, but indicates performance which most units will exhibit.
 - Nominal Value indicates the expected, but not *warranted*, value of the parameter.
-

Vertical Specifications

Table 5-1. Vertical Specifications

Bandwidth (–3 dB):	20 GHz (extended BW off) 40 GHz (extended BW on)
dc accuracy ($\pm 5^\circ$ C from cal):	The larger of $\pm 2\%$ of signal amplitude or 500 μ V The larger of $\pm 1\%$ of signal amplitude or 500 μ V (typical)
Noise floor (at 1 GHz):	<1.4 mV _{rms}

Input Channel Specifications

CAUTION

Input channels RF INPUT 1 and RF INPUT 2 are dc coupled.

Table 5-2. Input Channel Specifications

Operation input range: (including dc offset)	< ± 320 mB
Maximum safe input voltage without damage:	± 2 V _{pk-pk}
Number of input channels:	2
Input connectors ^a	2.4 mm (male)
Nominal input impedance:	50 Ω
Programmable dc offset:	± 320 mV

a. Includes two 2.4 mm (f) to 3.5 mm (f) adapters.

Trigger Specifications

Table 5-3. Trigger Specifications

Operation input range: (including dc offset)	$<\pm 320$ mV
Maximum safe input voltage without damage	$\pm 2 V_{\text{pk-pk}}$
Number of input channels:	2
Input connectors: ^a	2.4 mm (male)
Nominal input impedance:	50 Ω
Programmable dc offset:	± 320 mV

a. Includes two 2.4 mm (f) to 3.5 mm (f) adapters.

Trigger Specifications

Table 5-4. Trigger Specifications

Trigger sensitivity (dc - 40 GHz):	65 mV _{pk-pk} (typical)
Jitter:	<2.5 ps _{rms}

Horizontal Specifications

These specifications are for the eye diagram analyzer only.

Table 5-5. Horizontal Specifications

Time scale range: (full scale is 10 divisions)	5 ps/div–100 s/div
Delta time measurement accuracy:	$1 \text{ ps or } < \frac{\textit{time span}}{\textit{number of trace points}}$ (whichever is larger)
Time delay in eye mode: (clock frequencies > 10 MHz)	$\frac{-\textit{timespan}}{2}$ to (1000) (time span)
Time delay in eyeline and pattern modes: Pattern repetition frequency > 10 MHz	$\frac{-\textit{timespan}}{2}$ to (1000) (time span)
Pattern repetition frequency ≤ 10 MHz	±2 pattern repetition lengths
Time delay between channels: ^a	<10 ps

a. Time delay between channels (up to ±20% of the time span) is correctable in software.

Declaration of Conformity

Declaration of Conformity

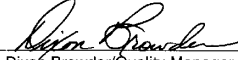
DECLARATION OF CONFORMITY <small>according to ISO/IEC Guide 22 and EN 45014</small>	
Manufacturer's Name:	Hewlett-Packard Co.
Manufacturer's Address:	Microwave Instruments Division 1400 Fountaingrove Parkway Santa Rosa, CA 95403-1799 USA
declares that the product	
Product Name:	Microwave Transition Analyzer
Model Number:	HP 71500A, HP 70820A
Product Options:	This declaration covers all options of the above products.
conforms to the following Product specifications:	
Safety: IEC 348:1978/HD 401 S1:1981 CAN/CSA-C22.2 No. 231 (Series M-89)	
EMC: CISPR 11:1990/EN 55011:1991 Group 1, Class A IEC 801-2:1984/EN 50082-1:1992 4 kV CD, 8 kV AD IEC 801-3:1984/EN 50082-1:1992 3 V/m, 27-500 MHz IEC 801-4:1988/EN 50082-1:1992 0.5 kV Sig. Lines, 1 kV Power Lines IEC 555-2:1982 +A1:1985 / EN 60555-2:1987 IEC 555-3:1982 + A1:1990 / EN 60555-3:1987 + A1:1991	
Supplementary Information: The product herewith complies with the requirements of the Low Voltage Directive 73/23/EEC and the EMC Directive 89/336/EEC. The HP 70820A Microwave Transition Analyzer was tested in HP 70004A Color Displays. Safety qualification tests for these products were performed prior to 1 December 1993.	
Santa Rosa, California, USA	28 Dec. 1995  Dixon Browder/Quality Manager
<small>European Contact: Your local Hewlett-Packard Sales and Service Office or Hewlett-Packard GmbH, Department HQ-TRE, Herrenberger Strasse 130, D-71034 Böblingen, Germany (FAX +49-7031-14-3143)</small>	

Numerics

- 0 level description, 3-4
- 1 Level description, 3-4
- 10 MHz reference, 1-11
- 70820A calibration, 3-61
- 70820A clock control, 3-21
- 70820A connections, 1-13
- 70820A menus, 3-14
- 70820A user-corrections, 3-49
- 70841A/B pattern generator, 1-24

A

- accessories, 1-15
- accessories required, 1-14
- add time delay, 2-28
- additional margin testing, 2-20
- Agilent 70820A menus, 3-14
- ALIGN command, 4-4
- align mask, 3-32
- amplitude and phase transitions, 3-5
- analysis, eye-diagram, 1-2
- application tutorials, 2-2
- apply user-corrections, 3-17
- attenuator, 1-15
- attenuator required, 1-14
- automatic measurements, 3-3
- automatically load the personality, 1-16
- autoranging, 1-11
- AUTOST file, 1-18
- average trace, 3-26
- averaging submenu, 3-27

B

- bandwidth to 40 GHz, 3-17
- battery, memory card, 3-39
- BIT command, 4-5
- bits displayed, 3-16

C

- cables, 1-14, 1-15
- calibrate IF for accuracy, 3-23
- calibrating IF, 3-64
- calibrating the eye-diagram analyzer, 3-23
- calibration
 - 70820A, 3-61

- data, 3-66
- date, 3-65
- IF, 3-64
 - menu, 3-62
 - offset, 2-5
- calibration, menus, 3-12
- calibrator frequency amplitude, 3-70
- calibrator signal control, 3-69
- calibrator signal on, 3-70
- care of fiber optics, 1-iv
- catalog files, 3-42
- channel, user-correction, 3-51
- channels versus traces, 3-6
- CLEAR command, 4-5
- clock control, 3-21
- color grading persistence, 3-28
- command
 - ALIGN, 4-4
 - BIT, 4-5
 - CLEAR, 4-5
 - DEFAULT, 4-6
 - DELAY, 4-7
 - DIAGRAM, 4-7
 - EXTIN, 4-8
 - MARGIN, 4-9
 - MARMSK, 4-9
 - MEAS, 4-10
 - PERSIST, 4-11
 - QUIT, 4-12
- commands, preview, 3-20
- compensate for dc offsets, 3-23
- configure data signal, 2-2
- connect the equipment, 1-12
- connections front panel, 1-14
- connections without a laser source and converter, 1-16
- constructing a low-pass filter from a transfer function, 2-30
- control the 70820A clock, 3-21
- controlling an 70841A/B pattern generator, 1-24
- controlling calibrator signal, 3-69
- controlling the display, 3-16
- Converter, laser and optical-to-electrical, 1-15
- copy of display, 3-47
- create a horizontal histogram, 2-41
- create a vertical histogram, 2-36
- create mask or limit line, 2-24

Index

- create print, 3-47
- crossing level description, 3-5
- custom keypad, 1-3
- custom mask or limit line testing, 2-23
- custom prefix, 3-45

D

- data pattern display, 2-27
- data signal configuration, 2-2
- data, user-corrections, 3-20
- date and time viewing, 3-21
- date code of firmware, 3-20
- dc offset compensation, 3-23
- default and custom mask or limit line testing, 2-23
- DEFAULT command, 4-6
- definition
 - INSTR PRESET key, 1-11
- definitions
 - 0 level, 3-4
 - 1 level, 3-4
 - crossing level, 3-5
 - extinction ratio, 3-4
 - eye height, 3-4
 - eye jitter, 3-5
 - eye width, 3-5
 - mean fall time, 3-5
 - mean rise time, 3-5
 - measurements, 3-4
- delay a channel, 3-64
- delay addition, 2-28
- delay between channels, matching, 3-63
- DELAY command, 4-7
- delete a line of data, 3-55
- description
 - eye-diagram measurements, 3-3
 - masks and limit lines, 3-9
 - setup and trg, cal menu, 3-12
- DIAGRAM command, 4-7
- disk
 - GPIB, 3-37
 - internal RAM, 3-37
- display
 - copy, 3-47
 - traces, 3-25
- display control, 3-16
- display the data pattern, 2-27

- display trace errors, 2-21
- display traces, 3-25
- display, number of bits, 3-16
- display, plot, 3-48
- displaying traces, 3-25
- duplicate, memory card, 3-41

E

- edit a line of data, 3-55
- edit mask or limit line, 2-24
- enter a line of data, 3-54
- entering and editing user-corrections, 3-52
- erase files, 3-43
- erase mask or limit line, 3-46
- erase user-correction file, 3-60
- errors, stop on and display trace, 2-21
- example
 - 70841A/B status screen, 1-24
 - autoscaled display of low-level signal, 2-11
 - display of user error in pattern mode, 2-29
 - extinction ratio measurement, 2-7
 - extinction ratio measurement on low-level signal with eye filtering, 2-12
 - eye measurements, 2-6
 - eyeline display showing laser overshoot, 2-17
 - filtered laser overshoot, 2-18
 - large overshoot resulting from laser bias, 2-5
 - laser overshoot and turn-on delay, 2-14
 - limit line displayed on screen, 3-10
 - pattern mode display, 2-28
 - two masks displayed on screen, 3-9
 - user-corrections applied to the data, 2-16
 - user-created mask, 2-23
- extend the bandwidth to 40 GHz, 3-17
- EXTIN command, 4-8
- extinction ratio description, 3-4
- extinction ratio measurement, 2-6
 - modes available, 1-5
- extinction ratios on low-level signals, 2-10
- eye filtering, 2-12
- eye height description, 3-4
- eye jitter description, 3-5
- eye measurements, example, 2-6
- eye mode, 1-5, 1-6
- eye width description, 3-5
- eye-diagram analysis, 1-2

eye-diagram analyzer reference, 3-2
 eye-diagram analyzer, calibrating, 3-23
 eye-diagram menus, 3-12
 eyeline
 software filters, 1-9
 eyeline mode, 1-5, 1-7, 2-13

F

fails, program loading, 1-17
 fast amplitude and phase transitions, 3-5
 features of modes, 1-5
 fiber optics
 care of, 1-iv
 file prefixes, 3-40
 files
 user-correction, 1-9, 3-18
 files, catalog, 3-42
 files, change prefix, 3-44
 files, custom prefix, 3-45
 files, erase, 3-43
 files, recall, 3-43
 filter, from a transfer function, 2-30
 filter, laser overshoot, 2-18
 filter, software, 2-17
 filters, software, 2-15
 firmware date code, 3-20
 flat-line interpolation, 3-55
 formatting a memory card, 3-37
 formatting memory, 3-34
 four traces can be displayed, 3-25
 front-panel connections, 1-14

G

generating histograms, 3-7
 getting started with the eye-diagram analyzer,
 1-2
 GPIB disk, 3-37
 GPIB, disk drives, 3-36
 guided instructions, 1-20

H

histogram menu, 3-7
 histogram type selection, 2-36
 histogram, horizontal creation, 2-41
 histogram, selection, 2-36

histogram, vertical creation, 2-36
 histograms, generating, 3-7
 horizontal histogram creation, 2-41

I

IF calibration, 3-64
 improve the sensitivity in eyeline mode, 3-17
 industry standards testing, 2-19
 infinite monochrome persistence, 3-28
 initializing a memory card, 3-37
 input connector, 1-iv
 INSTR PRESET key definition, 1-11
 instructions on the screen, 1-19
 internal RAM disk, 3-37
 interpolation, flatline, 3-55
 interpolation, logarithmic slope, 3-55

K

keypad, custom, 1-3

L

laser and optical-to-electrical converter, 1-15
 laser bias affects overshoot, 2-5
 laser overshoot and turn-on delay, 2-14
 laser overshoot filtered, 2-18
 left-side menu keys, 3-15
 limit line displayed on screen, 3-10
 limit line or mask creation, 2-24
 limit line or mask editing, 2-24
 limit line or mask testing, 2-23
 limit lines and mask, 1-8
 load state or mask or limit line, 3-45
 load the personality, 1-16
 loading software filter, 2-17
 logarithmic slope interpolation, 3-55
 low-level signals, extinction ratios, 2-10
 low-pass filter from a transfer function, 2-30

M

manually load the personality, 1-17
 manually set the trigger level, 1-25
 MARGIN command, 4-9
 markers
 using, 3-30

Index

- markers turned on, 2-13
 - markers, menus, 3-13
 - MARMSK command, 4-9
 - mask align, 3-32
 - mask and limit lines, 1-8
 - mask margins, 3-32
 - mask or limit line creation, 2-24
 - mask or limit line editing, 2-24
 - mask setup menu, 3-33
 - mask testing
 - applying, 3-31
 - modes available, 1-5
 - masks and limit lines, 3-9
 - masks and limit lines description, 3-9
 - masks displayed on screen, 3-9
 - masks, menus, 3-13
 - mass storage, 3-34
 - mass storage, menus, 3-13
 - matching delay between channels, 3-63
 - mean fall time description, 3-5
 - mean rise time description, 3-5
 - MEAS command, 4-10
 - measure in optical power units, 3-16
 - measure, menus, 3-13
 - Measurement Conditions, 1-22
 - measurement plane, 1-10, 1-26
 - measurements
 - definitions, 3-4
 - extinction ratio, 2-6, 2-12
 - fast amplitude and phase transitions, 3-5
 - in optical power units, 3-16
 - laser turn-on delay, 2-13
 - optical power units, 2-8
 - memory
 - selecting and formatting, 3-34
 - memory card
 - battery, 3-39
 - duplicate, 3-41
 - loading personality, 1-18
 - memory card, formatting, 3-37
 - memory cards, 3-34
 - menus
 - 70820A, 3-14
 - Agilent 70820A, 3-14
 - averaging, 3-27
 - calibration, 3-62
 - eye-diagram, 3-12
 - histogram, 3-7
 - left-side, 3-15
 - maps, 3-12
 - mask setup, 3-33
 - module main, 1-17
 - persistence, 3-28
 - setup and trg and cal, 3-12
 - setup and trg, cal, 3-12
 - traces, measure, markers, masks, and mass storage menus, 3-13
 - traces, measure, markers, masks, storage, 3-13
 - user-correction, 3-51
 - mode selection, 1-22
 - modes, features, 1-5
 - monochrome grading persistence, 3-29
 - monochrome persistence, 3-28
 - move the measurement plane, 1-26
- ## N
- number of bits displayed, 3-16
- ## O
- offset calibration, 2-5
 - optical power units, 3-16
 - optical power units display, 3-16
 - optical power units measurement, 2-8
 - optimum performance, 3-6
 - outline, setting up eye-diagram, 1-4
 - overshoot resulting from laser bias, 2-5
- ## P
- pass/fail testing, 1-8
 - pattern display, 2-27
 - pattern generator settings, 1-23
 - pattern generator, 70841A/B, 1-24
 - pattern mode, 1-8
 - pattern modes, 1-5
 - performing self-test, 3-69
 - PERSIST command, 4-11
 - persistence modes, 3-27
 - personality loading, 1-16
 - plotting, 3-48
 - position and scale each trace, 3-26
 - preset state, 1-26
 - preview programming commands, 3-20

printing, 3-47
 PROG
 STR? to read response, 4-3
 program failed to load, 1-17
 program variables, values, 4-5
 programming commands, 4-2
 programming commands, preview, 3-20

Q

QUIT command, 4-12

R

RAM disks, 3-35
 read response, PROG
 STR?, 4-3
 rear-panel connections, 1-13
 recall files, 3-43
 recall, mask or limit line, 3-46
 recall, user-correction file, 3-60
 reference, 10 MHz, 1-11
 reference, eye-diagram analyzer, 3-2
 repetitive and non-repetitive signals, 3-5
 restore the factory instrument preset, 1-27
 return to the jitter analyzer (or eye-diagram analyzer), 3-20
 RF correction, on off, 3-62

S

safety information, 1-iii
 save
 instrument state as preset state, 1-26
 save, files, 3-42
 save, instrument state, 3-45
 save, mask or limit line, 3-46
 saving
 mass storage, 3-34
 user-correction file, 3-59
 saving, recalling, cataloging user-correction files, 3-59
 scale and position each trace, 3-26
 scale trace, 3-26
 screen instructions, 1-19
 select single or continuous sweeps, 1-22
 select the mode, 1-22
 select the pattern generator settings, 1-23

select trigger source, 1-22
 selecting memory, 3-34
 self-guided screen, 1-20
 self-test, 3-69
 sensitivity in eyeline mode, 3-17
 set up measurement conditions, 1-22
 setting up eye-diagram analysis, 1-4
 setup and trg, cal, 3-12
 signals, repetitive and non-repetitive, 3-5
 softkeys, left-side menu, 3-15
 software filter loading, 2-17
 software filters, 1-9
 software filters, using, 2-15
 standards, testing, 2-19
 statistical analysis, 2-38, 2-43
 stop on and display trace errors, 2-21
 storage, GPIB disk, 3-37
 storage, internal RAM, 3-37
 sweep selection, 1-22
 sweeps available, 1-10

T

test to industry standards, 2-19
 testing responses, 3-11
 testing, mask or limit line, 2-23
 testing, with additional margin, 2-20
 time and date viewing, 3-21
 time delay addition, 2-28
 trace
 average, 3-26
 trace 2 delay compensated, 3-64
 trace averaging, 3-26
 trace errors, 2-21
 trace, error, 3-32
 trace, persistence, 3-27
 trace, position, 3-26
 trace, scale, 3-26
 traces
 display, 3-25
 displayed, 3-25
 persistence modes, 3-27
 position and scale, 3-26
 traces, displaying, 3-25
 traces, measure, markers, masks, and mass storage menus, 3-13
 transfer function, constructing a low-pass filter, 2-30

Index

- trigger level, manually set, 1-25
- trigger source, 1-22
- trigger, menus, 3-12
- turn calibrator signal on, 3-70
- turning off RF correction, 3-62
- tutorials
 - application, 2-2
 - constructing a low-pass filter from a transfer function, 2-30
 - create a horizontal histogram, 2-41
 - create a vertical histogram, 2-36
 - default and custom mask or limit line testing, 2-23
 - display the data pattern, 2-27
 - extinction ratios on low-level signals, 2-10
 - eye-parameters, 2-4
 - measure laser turn-on delay, 2-13
 - measurement in optical power units, 2-8
 - test to industry standards, 2-19
 - use software filters, 2-15
- two masks displayed on screen, 3-9

U

- user correction files, supplied, 2-15
- user-correction
 - applied to data example, 2-16
 - files, 1-9
 - modes available, 1-5
- user-correction file
 - erase, 3-60
 - recalling, 3-60
 - saving, 3-59
- user-correction files, 3-18
- user-correction, files, 3-18
- user-corrections
 - 70820A, 3-49
 - applying, 3-17
 - channel selection, 3-51
 - copy to alternate channel, 3-56
 - delete a channel, 3-52
 - displayed, 3-20
 - entering and editing, 3-52
 - example, 3-50
 - menu, 3-51
 - on off, 3-51
- user-corrections applied to the data, 3-20
- user-error in pattern mode, 2-29

V

- values of program variables, 4-5
- variable monochrome persistence, 3-28
- variables to pass commands and data, 4-3
- vertical histogram, 2-36
- viewing
 - 70820A menus, 3-20
 - calibration data, 3-66, 3-68
 - date and time, 3-21
 - error trace, 3-32
 - hardware response traces, 3-67
 - IF correction data traces, 3-66
 - last calibration date, 3-65
 - repetitive and non-repetitive signals, 3-5
 - signal in optical units, 2-12
 - the firmware date code, 3-20
 - user-correction data, 3-56