

# **Read This First**

**HP 70620B and HP 70621A Preamplifier  
Installation and Verification Manual  
HP Part Number: 70620-90022**

**This manual was designed to be inserted into and used with your existing HP 70000 Modular Measurement System documentation. Use the following instructions to insert this manual into the system master's installation and verification manual.**

- 1. Remove the shrink wrap covering this manual.**
- 2. Remove the tab provided and place it at the end of the system master's installation and verification manual.**
- 3. Place this manual behind the tab that was added in step 2.**



**Printed in USA**

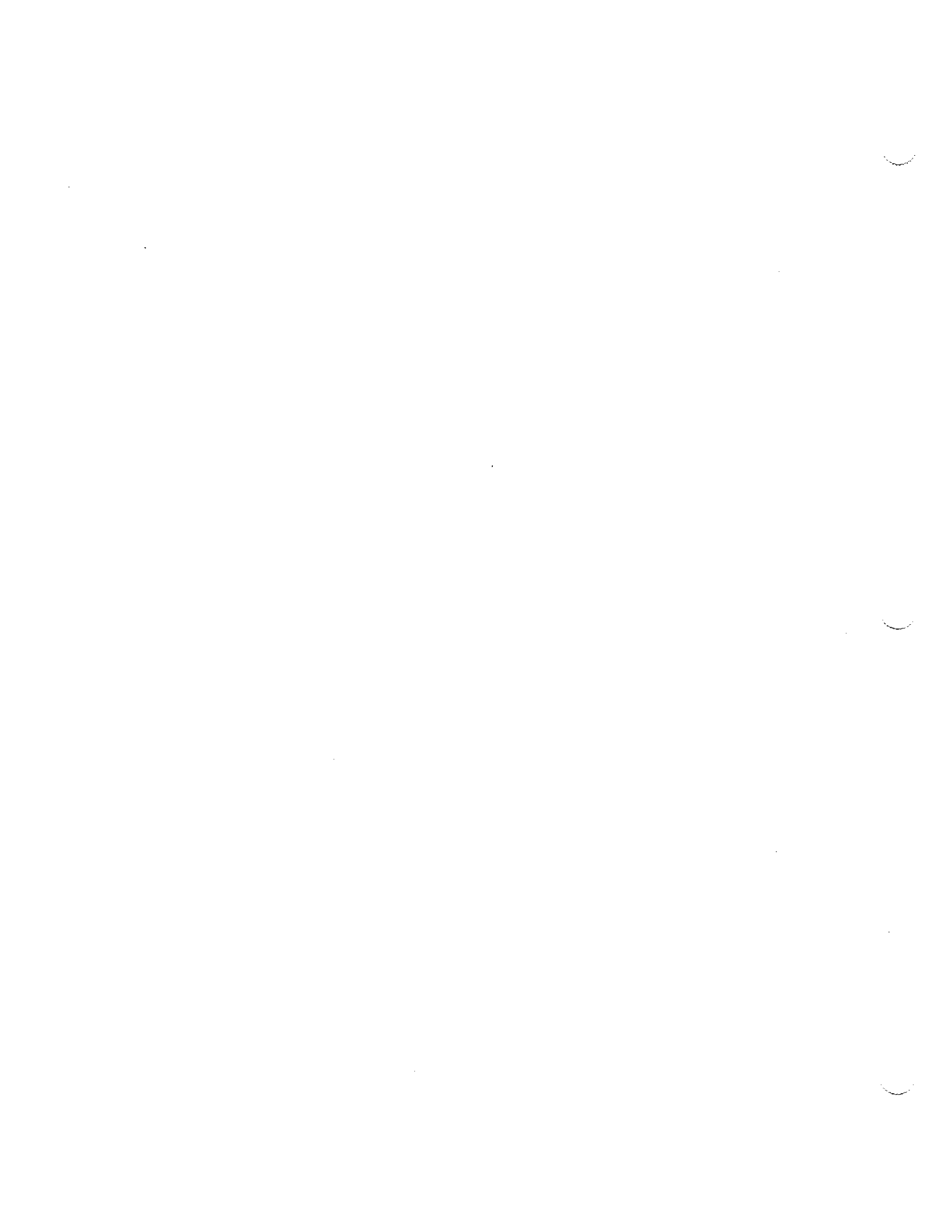

# **Installation and Verification Manual**

## **HP 70620B and HP 70621A Preamplifier**



**HP Part No. 70620-90022    Microfiche Part No. 70620-90023**  
**Printed in USA    June 1990**

©Copyright Hewlett-Packard Company 1990

All Rights Reserved. Reproduction, adaptation, or translation without prior written permission is prohibited, except as allowed under the copyright laws.

1212 Valley House Drive, Rohnert Park, CA 94928-4999, USA

---

## Certification

Hewlett-Packard Company certifies that this product met its published specifications at the time of shipment from the factory. Hewlett-Packard further certifies that its calibration measurements are traceable to the United States National Institute of Standards and Technology, to the extent allowed by the Institute's calibration facility, and to the calibration facilities of other International Standards Organization members.

---

## Warranty

This Hewlett-Packard instrument product is warranted against defects in material and workmanship for a period of one year from date of shipment. During the warranty period, Hewlett-Packard Company will, at its option, either repair or replace products which prove to be defective.

For warranty service or repair, this product must be returned to a service facility designated by Hewlett-Packard. Buyer shall prepay shipping charges to Hewlett-Packard and Hewlett-Packard shall pay shipping charges to return the product to Buyer. However, Buyer shall pay all shipping charges, duties, and taxes for products returned to Hewlett-Packard from another country.

Hewlett-Packard warrants that its software and firmware designated by Hewlett-Packard for use with an instrument will execute its programming instructions when properly installed on that instrument. Hewlett-Packard does not warrant that the operation of the instrument, or software, or firmware will be uninterrupted or error-free.

### LIMITATION OF WARRANTY

The foregoing warranty shall not apply to defects resulting from improper or inadequate maintenance by Buyer, Buyer-supplied software or interfacing, unauthorized modification or misuse, operation outside of the environmental specifications for the product, or improper site preparation or maintenance.

NO OTHER WARRANTY IS EXPRESSED OR IMPLIED. HEWLETT-PACKARD SPECIFICALLY DISCLAIMS THE IMPLIED WARRANTIES OF MERCHANTABILITY AND FITNESS FOR A PARTICULAR PURPOSE.

### EXCLUSIVE REMEDIES

THE REMEDIES PROVIDED HEREIN ARE BUYER'S SOLE AND EXCLUSIVE REMEDIES. HEWLETT-PACKARD SHALL NOT BE LIABLE FOR ANY DIRECT, INDIRECT, SPECIAL, INCIDENTAL, OR CONSEQUENTIAL DAMAGES, WHETHER BASED ON CONTRACT, TORT, OR ANY OTHER LEGAL THEORY.

---

## Assistance

*Product maintenance agreements and other customer assistance agreements are available for Hewlett-Packard products.*

*For any assistance, contact your nearest Hewlett-Packard Sales and Service Office.*

---

## Safety Symbols

The following safety symbols are used throughout this manual. Familiarize yourself with each of the symbols and its meaning before operating this instrument.

---

### Caution



The *caution* sign denotes a hazard. It calls attention to a procedure which, if not correctly performed or adhered to, could result in damage to or destruction of the instrument. Do not proceed beyond a *caution* sign until the indicated conditions are fully understood and met.

---

### Warning



The *warning* sign denotes a hazard. It calls attention to a procedure which, if not correctly performed or adhered to, could result in injury or loss of life. Do not proceed beyond a *warning* sign until the indicated conditions are fully understood and met.

---

## General Safety Considerations

---

### Warning



*Before this instrument is switched on, make sure it has been properly grounded through the protective conductor of the ac power cable to a socket outlet provided with protective earth contact.*

**Any interruption of the protective (grounding) conductor, inside or outside the instrument, or disconnection of the protective earth terminal can result in personal injury.**

---

### Warning



**There are many points in the instrument which can, if contacted, cause personal injury. Be extremely careful.**

**Any adjustments or service procedures that require operation of the instrument with protective covers removed should be performed only by trained service personnel.**

---

### Caution



*Before this instrument is switched on, make sure its primary power circuitry has been adapted to the voltage of the ac power source.*

**Failure to set the ac power input to the correct voltage could cause damage to the instrument when the ac power cable is plugged in.**

---

## HP 70000 Modular Measurement System Documentation Outline

Instruments and modules of the HP 70000 Modular Measurement System are documented to varying levels of detail. Modules that serve as masters of an instrument require operation information in addition to installation and verification instructions. Modules that function as slaves in a system require only a subset of installation and verification information.

---

### Manuals Supplied with Module

#### Installation and Verification Manual

Topics covered by this manual include installation, specifications, verification of module operation, and some troubleshooting techniques. Manuals for modules that serve as instrument masters will supply information in all these areas; manuals for slave modules will contain only information needed for slave module installation and verification. Master module documentation may also include some system-level information.

#### Operation Manual

Operation Manuals usually pertain to multiple- and single-module instrument systems. Topics include preparation for module use, module functions, and softkey definitions.

#### Programming Manual

Programming Manuals also pertain to multiple- and single-module instrument systems. Programming Manual topics include programming fundamentals and definitions for remote programming commands.

---

### Service Manual, Available Separately

This manual provides service information for a module, including module verification tests, adjustments, troubleshooting, replaceable parts lists, and replacement procedures. For ordering information, contact a Hewlett-Packard Sales and Service Office. This manual is not always immediately available for new products.

---

#### Note

Some earlier service manuals are titled *Technical Reference*.



31

10  
11  
12

13

14

15

16

17

18

19

20

21

22

23

24

25





## General Information

---

### Introduction

The *HP 70620B/HP 70621A Preamplifier Installation and Verification Manual* contains information needed to install the preamplifiers in an HP 70000 Modular Measurement System. For system-level information, refer to the Installation and Verification Manual for the system's master (for example, HP 70900B).

This manual contains the following chapters:

- Chapter 1, "General Information," describes the modules and their accessories, gives electrostatic discharge and packaging information, and lists Hewlett-Packard Sales and Service Offices.
- Chapter 2, "Installation," provides information for configuring and installing the modules in HP 70000 Modular Measurement Systems.
- Chapter 3, "Specifications," lists module specifications and characteristics. The Installation and Verification Manual for the system's master contains any system specifications that will be modified when the HP 70620B or HP 70621A are added to a system.
- Chapter 4, "Verification," contains information about the tests needed to verify the specifications given in Chapter 3.
- Chapter 5, "Troubleshooting," explains the most probable causes of the front-panel status and error LEDs' lighting, and lists the error codes that can be generated by the HP 70620B or HP 70621A modules.

---

### Manual Conventions

The following descriptions are used throughout this manual:

Keys physically on an instrument are represented in the following way:

Key ..... **KEY**

Softkeys, keys defined by software or firmware, are represented in the following way:

Softkey ..... **softkey**

Text that appears on the display screen is represented in the following way:

Screen text ..... **screen text**

---

## Safety Considerations

Before operating this module, familiarize yourself with any safety markings on the module and the safety instructions in this manual. This module has been manufactured and tested according to international safety standards. However, to ensure safe operation of the module and personal safety of the user and service personnel, the cautions and warnings in this manual must be followed. Refer to the summary of safety considerations at the front of this manual.

---

## Serial Numbers

Attached to the front frame of the module is a serial-number label. The serial number is in two parts. The first four digits and letter are the serial number prefix; the last five digits are the suffix. See Figure 1-1. The prefix is the same for all identical modules; it only changes when a change is made to the module. The suffix, however, is assigned sequentially and is different for each module.

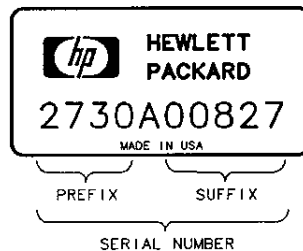

**Figure 1-1. Typical Serial Number Label**

---

## Initial Inspection

Inspect the shipping container for damage. If the shipping container or cushioning material is damaged, it should be kept until the contents of the shipment have been checked for completeness and the module has been checked mechanically and electrically. Refer to the accessory information on the following pages to find out what is shipped with the module.

If the shipping contents are not complete, or the module does not pass the procedures in Chapter 4, notify the nearest Hewlett-Packard office. If the shipping container is damaged, or the cushioning material shows signs of stress, notify the carrier as well as the Hewlett-Packard office. Keep the shipping materials for the carrier's inspection. The Hewlett-Packard office will arrange for repair or replacement without waiting for claim settlement.

---

## Module Description

The HP 70620B and HP 70621A Preamplifiers are 1/8-width modules designed to plug into an HP 70000 series mainframe. The preamplifiers are low-noise, high-gain amplification stages to use in front of the RF section of any HP 70000 series RF or microwave spectrum analyzer. Refer to Table 1-1 for information about preamplifier frequency ranges.

**Table 1-1. Frequency Ranges**

Preamplifier	Frequency Range
HP 70620B	1 GHz to 26.5 GHz
HP 70620B Option 001	100 kHz to 26.5 GHz
HP 70621A	100 kHz to 2.9 GHz

The front-panel +28 V dc output provides a noise-source drive voltage. This allows the spectrum analyzer system to be used to make noise-figure measurements. Refer to Application Note 57-1, *Fundamentals of RF and Microwave Noise Figure Measurements*.

Adding a preamplifier to a system greatly reduces the system noise figure, resulting in an improvement in sensitivity. For example, when a preamplifier is added to an HP 71210C system, the resulting system noise figure is typically 6 or 11 dB. This corresponds to an improvement in sensitivity of approximately 20 dB. The improved sensitivity allows the use of wider bandwidths and shorter sweep times, resulting in faster measurement time.

The modular preamplifiers automatically calibrate the display of the spectrum analyzer, correcting for preamplifier gain and flatness. Gain and flatness correction data in the preamplifier's ROM is sent to the spectrum analyzer ensuring an adjusted and properly positioned display. Flatness data for the bypass mode is also corrected by the analyzer.

To compensate for the preamplifier's gain, the spectrum analyzer's IF step-gains may change when the preamplifier is switched on. This maintains a constant reference level. To ensure a safe level at the mixer input, the RF attenuation may even be changed if the maximum mixer level is exceeded.

## Preamplifier Modes

The preamplifiers have two modes: preamplifier and bypass. (See Figure 1-2, Figure 1-3, and Figure 1-4.) When used with the HP 70000 spectrum analyzer, the mode is "bypass." When the preamplifier is used without the 70900 LO master module, its default mode is preamplifier on.

Modes can be selected using either a softkey or a remote command. Information about using the softkey to select the mode is given below. Refer to the system master's Programming Manual for remote-operation information.

**Preamplifier** The preamplifier mode is selected by toggling the **PREAMP1/On Off** softkey to On. Press **State**, **MORE**, **preamp control**, then **PREAMP1/On Off**.

**Bypass** The bypass mode is selected by toggling the **PREAMP1/On Off** softkey to Off.

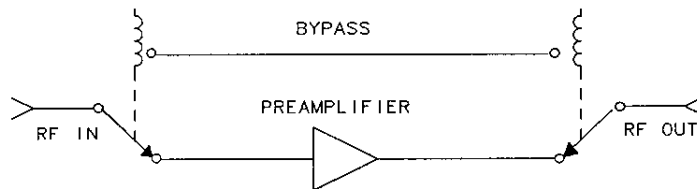

Figure 1-2. Paths for Bypass and Preamplifier Modes: HP 70620B (1 GHz to 26.5 GHz)

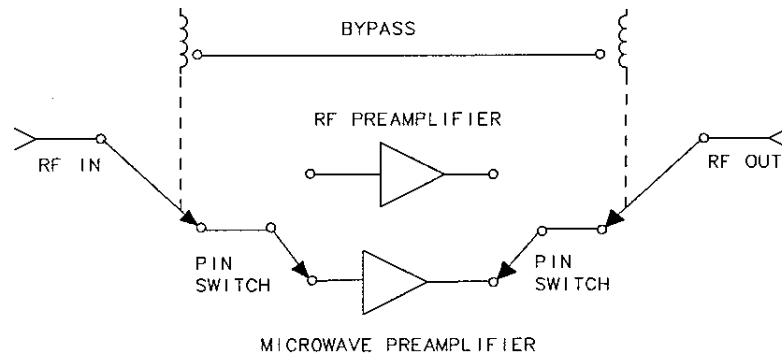

Figure 1-3.

Paths for Bypass and Preamplifier Modes: HP 70620B Option 001 (100 kHz to 26.5 GHz)

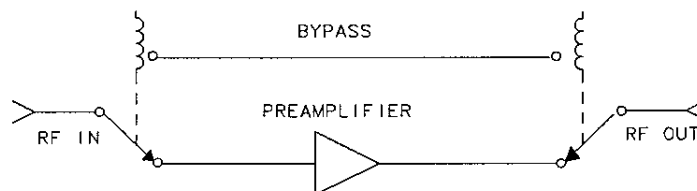

Figure 1-4. Paths for Bypass and Preamplifier Modes: HP 70621A (100 kHz to 2.9 GHz)

---

## Module Options

The HP 70620B and HP 70621A modules have the following module options available.

- Option 001** This option is available only for the HP 70620B. This option combines the HP 70621A capabilities with the HP 70620B capabilities, extending the module's low-end frequency range to 100 kHz. This results in a total frequency range of 100 kHz to 26.5 GHz. PIN diode switches allow full-band sweep.
- Option 098** This option adds the latest controller-board/firmware upgrade kit for the HP 70900A Local Oscillator. This option is required if the existing system HP 70900A contains firmware version 850730 or 860203.
- Option 099** This option adds the latest RAM/ROM upgrade kit for the HP 70900 local oscillator. This option is required if the existing system HP 70900 contains a firmware version earlier than 900314. (Option 099 is not necessary if Option 098 is ordered.)
- Option 910** This option adds another set of the manuals that normally ship with the module. The preamplifiers are shipped with this Installation and Verification Manual.
- Option 915** This option adds the module service documentation and module verification software.

---

## Firmware Compatibility

For the HP 70620B or HP 70621A to function properly in an HP 70000 Modular Measurement System, the HP 70900 local oscillator must have a firmware version of 900314 or later. A firmware-upgrade kit is included when either module option 098 or 099 is ordered. Refer to "Module Options" for more information.

---



## Examples of Configurations Using Preamplifiers

The HP 70620B and HP 70621A preamplifiers can be used in a variety of configurations depending on your application needs. If overload or multiple responses are a concern, an HP 70600A or HP 70601A preselector can also be added to the system. Spur searching that involves a carrier signal requires a preselector to eliminate analyzer image and multiple responses. See Table 1-2 for examples of configurations for the following applications:

- A system with a preamplifier provides the highest sensitivity for testing low-level signals. (See Table 1-2, example A.)
- The preamplifier precedes a preselector for best sensitivity. (See Table 1-2, example B.)
- A preselector precedes the preamplifier to minimize chances of the preamplifier being overloaded. The preamplifier can be overloaded if the spur searching involves many high-level signals or if a low-level signal of interest is in an environment containing high-power signals. Because there is some insertion loss through the preselector, optimum sensitivity is not achieved in this configuration. (See Table 1-2, example C.)
- Bracketing a preselector with preamplifiers allows a large amount of gain for maximum improvement in noise figure in a preselected receiver. (See Table 1-2, example D.)

Refer to the “Accessories” section later in this chapter for information about cables.

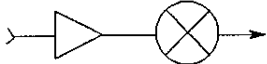
**Table 1-2. Configurations with Preamplifiers**

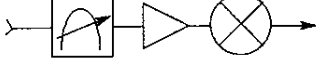
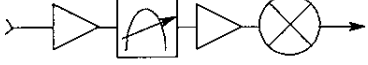
Example	Configuration	Application	Advantage
A		Low-level signals in a known signal environment	Highest sensitivity
B		Spur searching	Preselector eliminates images High sensitivity
C		Identifying a low-power signal in an environment with high-power signals or a dense signal environment	Preselector minimizes overload Better sensitivity
D		Very low-level signals in a multilevel environment	Large amount of gain for maximum improvement in noise figure in a preselected receiver. Flexibility of adding gain where most appropriate. This configuration has all of the advantages of the examples above.

---

## Front- and Rear-Panel Features

Figure 1-5 shows the HP 70620B and HP 70621A front and rear panels.

### Status and Error LEDs

Both of the front-panel LEDs flash on, then off again, during the module's self-test. Listed below are the other reasons for each LED to light. For troubleshooting information, refer to Chapter 5.

- ACT** The ACT (active) LED lights when the module is being activated by an HP 70000 Modular System master that has an active keyboard link. If there is no display in the system, the ACT LED will not light.
- ERR** The ERR LED turns on when there is a problem (an error) related to the module. If the ERR LED blinks at a 1-Hz rate, there may be a problem with communication over the Hewlett-Packard Modular System Interface Bus (HP-MSIB). Refer to the system master's Installation and Verification Manual for an explanation of error reporting.

### Front-Panel Inputs and Outputs

- +28 VDC OUT** This BNC (f) connector provides a +28 V dc output for a noise-source drive. The signal is turned on and off to activate the noise source.
- RF OUTPUT** HP 70620B modules have an APC-3.5 (m) connector; HP 70621A modules have an SMA (f) connector. The RF OUTPUT connector presents a 50 $\Omega$  nominal output impedance and is normally connected to the RF section's RF input.
- RF INPUT** HP 70620B modules have a APC-3.5 (m) connector; HP 70621A modules have a Type N (f) connector. This connector provides a 50 $\Omega$  nominal input impedance.

### Module Latch

The module hex-nut latch secures the module in the mainframe. The latch requires an 8 mm hex-ball driver (supplied with the HP 70001A Mainframe). Refer to Chapter 2 for module-installation instructions.

### Rear-Panel Mainframe/Module Interconnect

This multiple-pin connector plugs into the mainframe and provides the power supplies and HP-MSIB for the module.



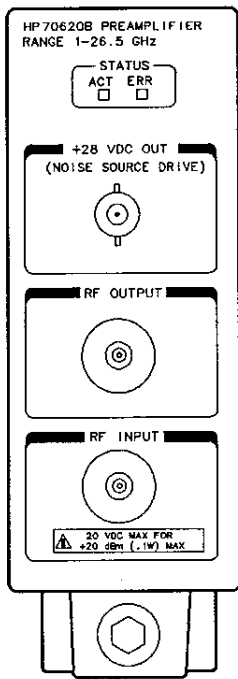

HP 70620B

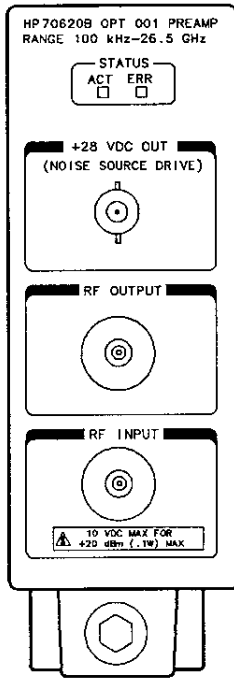

HP 70620B OPTION 001

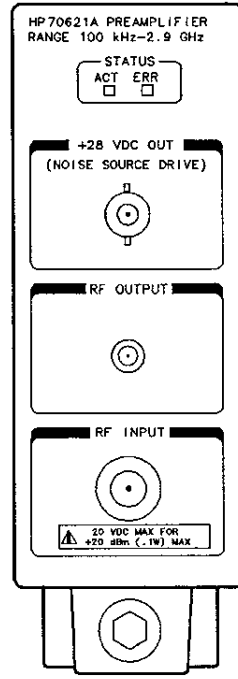

HP 70621A

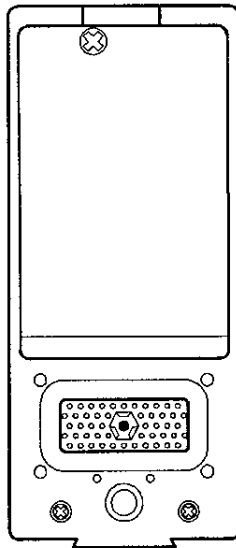

HP 70620B/HP 70621A

**Figure 1-5. HP 70620B and 70621A Front- and Rear-Panel Features**

## Accessories

The HP 70620B and HP 70621A preamplifiers are available separately or as part of a preconfigured system (which is assembled in a specific configuration in the factory). Preamplifiers in preconfigured systems come with the RF cables that are needed for that specific configuration. For a list of available system cables, refer to the Installation and Verification Manual for the system master.

When a preamplifier is ordered separately, it is shipped with a group of accessories that allow the most common system configurations. Table 1-3 lists the accessories shipped with preamplifiers when they are ordered separately. Table 1-4 lists accessories that are available, but are not shipped with the preamplifier. The accessories in these tables are those available at the print date of this manual.

In Table 1-3 and Table 1-4 below, the information in the “L/R” columns refers to signal flow “out” to “in” as viewed from the front panel. For example, if the signal source is to the left of the signal destination when viewed from the front panel, a “L to R” cable is needed. Bends in the semirigid cables make this distinction necessary.

**Table 1-3. Accessories Shipped when the Preamplifier is Ordered Separately**

Module	Accessory	Spans	L/R	Quantity Shipped	HP Part Number
HP 70620B	Cable, Semirigid, SMA (f) to Type N (m)	1	R to L	1	5022-0003
	Cable, Semirigid, SMA (f) to Type N (m)	2	R to L	1	5021-9952
	Cable, Semirigid, SMA (f) to SMA (f)	1	R to L	1	5021-9931
HP 70621A	Cable, Semirigid, SMA (m) to Type N (m)	1	R to L	1	5021-7402

**Table 1-4. Other Available Accessories**

Accessory	Spans	L/R	HP Model or Part Number
Noise Source	n/a	n/a	HP 346C
Adapter, SMA (f) to SMA (f)	n/a	n/a	1250-1158
Cable, Semirigid, Type N (m) to SMA (m)	1	R to L	5021-7402
Cable, Semirigid, Type N (m) to SMA (m)	2	R to L	5021-8636
Cable, Semirigid, SMA (m) to SMA (m)	1	R to L	5021-7403
Cable, Semirigid, SMA (m) to APC-3.5 (f)	1	n/a	5022-0064

## Electrostatic Discharge Information

Electrostatic discharge (ESD) can damage or destroy electronic components. Therefore, all work performed on assemblies consisting of electronic components should be done at a static-safe work station.

Figure 1-6 shows an example of a static-safe work station. Two types of ESD protection are shown: (a) conductive table mat and wrist strap combination, and (b) conductive floor mat and heel strap combination. The two types must be used together to ensure adequate ESD protection. Refer to Table 1-5 for a list of static-safe accessories and their part numbers.

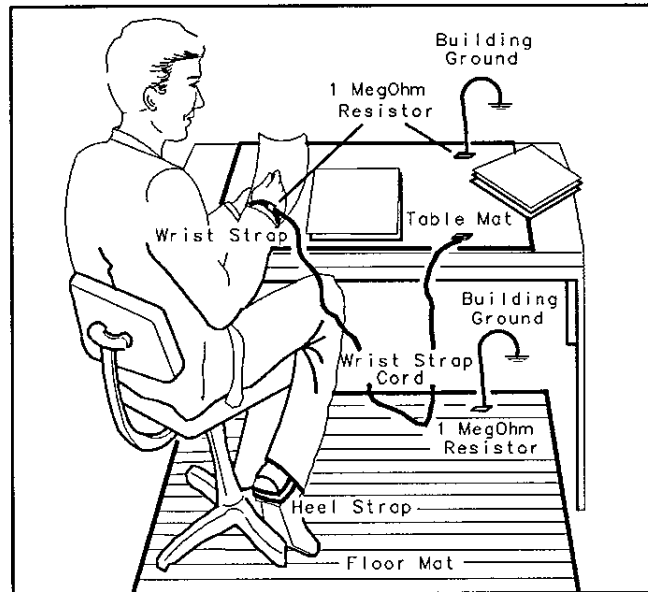

Figure 1-6. Static-Safe Work Station

### Reducing ESD Damage

Below are suggestions that may help reduce the amount of ESD damage that occurs during testing and servicing instruments.

#### PC Board Assemblies and Electronic Components

- Handle these items at a static-safe work station.
- Store or transport these items in static-shielding containers.

---

**Caution**

Do not use erasers to clean the edge-connector contacts. Erasers generate static electricity and degrade the electrical quality of the contacts by removing the thin gold plating.

Do not use paper of any kind to clean the edge-connector contacts. Paper or lint particles left on the contact surface can cause intermittent electrical connections.

Do not touch the edge-connector contacts or trace surfaces with bare hands. Always handle board assemblies by the edges.

---

PC board assembly edge-connector contacts may be cleaned by using a lint-free cloth with a solution of 80% electronics-grade isopropyl alcohol and 20% deionized water. This procedure should be performed at a static-safe work station.

**Test Equipment**

- Before connecting any coaxial cable to an instrument connector for the first time each day, *momentarily* short the center and outer conductors of the cable together.
- Personnel should be grounded with a resistor-isolated wrist strap before touching the center pin of any connector and before removing any assembly from the instrument.
- Be sure that all instruments are properly earth-grounded to prevent buildup of static charge.

## Static-Safe Accessories

**Table 1-5. Static-Safe Accessories**

Accessory	Description	HP Part Number
Static-control mat and ground wire	Set includes:  3M static-control mat, 0.6m × 1.2m (2 ft × 4 ft)  ground wire, 4.6m (15 ft) (The wrist strap and wrist-strap cord are <i>not</i> included. They must be ordered separately.)	9300-0797
Wrist-strap cord	1.5m (5 ft)	9300-0980
Wrist strap	Black, stainless steel with four adjustable links and 7-mm post-type connector (The wrist-strap cord is <i>not</i> included.)	9300-1383
ESD heel strap	Reusable 6 to 12 months	9300-1169
Hard-surface static-control mat*	Large, black, 1.2m × 1.5m (4 ft × 5 ft) Small, black, 0.9m × 1.2m (3 ft × 4 ft)	92175A 92175C
Soft-surface static-control mat*	Brown, 1.2m × 2.4m (4 ft × 8 ft)	92175B
Tabletop static-control mat*	58 cm × 76 cm (23 in. × 30 in.)	92175T
Antistatic carpet*	Small, 1.2m × 1.8m (4 ft × 6 ft) natural color russet color  Large, 1.2m × 2.4m (4 ft × 8 ft) natural color russet color	92176A 92176C  92176B 92176D
*These accessories can be ordered either through a Hewlett-Packard Sales Office or through HP DIRECT Phone Order Service. In the USA, the HP DIRECT phone number is (800) 538-8787. Contact your nearest Hewlett-Packard Sales Office for more information about HP DIRECT availability in other countries.		

---

## Returning Instruments for Service

The original shipping containers and materials, or the equivalent, must be used when repackaging the mainframe with modules, or modules alone. Packaging materials identical to the original factory packaging (see Figure 1-7) can be purchased through any Hewlett-Packard office. However, if these shipping materials are not available, instruments can be repackaged for shipment using the information below.

---

### Caution



Instrument damage can result from using packaging materials other than the original shipping materials or equivalent. Never use styrene pellets as packaging materials. They do not adequately cushion the instrument or prevent it from shifting in the carton. They cause instrument damage by generating static electricity.

---

Use the following procedure to prepare the instrument for shipment:

1. Fill out a blue repair card (located at the end of this manual) and attach it to the instrument. Also send copies of any error messages and performance data recorded for the instrument. If a blue repair card is not available, send the following information with the returned instrument:
  - a. Type of service required.
  - b. Description of the problem; state if the problem is constant or intermittent.
  - c. Name and phone number of technical contact person.
  - d. Return address.
  - e. Model number of returned instrument.
  - f. Full serial number of returned instrument.
  - g. List of any accessories returned with instrument.
2. Pack the instrument in the original shipping materials (or the equivalent). However, if these are not available, instruments can be repackaged for shipment using the following instructions.
  - a. Wrap the instrument in antistatic plastic to reduce the possibility of ESD-caused damage.
  - b. For instruments that weigh less than 54 kg (120 lb), use a double-walled, corrugated cardboard carton of 159 kg (350 lb) test strength. The carton must be large enough and strong enough to accommodate the instrument. Allow at least 3 to 4 inches on all sides of the instrument for packing material.
  - c. Surround the equipment with 3 to 4 inches of packing material to protect the instrument and prevent it from moving in the carton. If packing foam is not available, the best alternative is S.D.-240 Air Cap™ from Sealed Air Corporation (Commerce, California 90001). Air Cap is a plastic sheet filled with 1-1/4 inch air bubbles. Use the pink (antistatic) Air Cap to reduce static electricity. Wrapping the instrument several times in this material should both protect the instrument and prevent it from moving in the carton.
3. Seal the carton with strong nylon adhesive tape.
4. Mark the carton "FRAGILE, HANDLE WITH CARE."
5. Keep copies of all shipping papers.

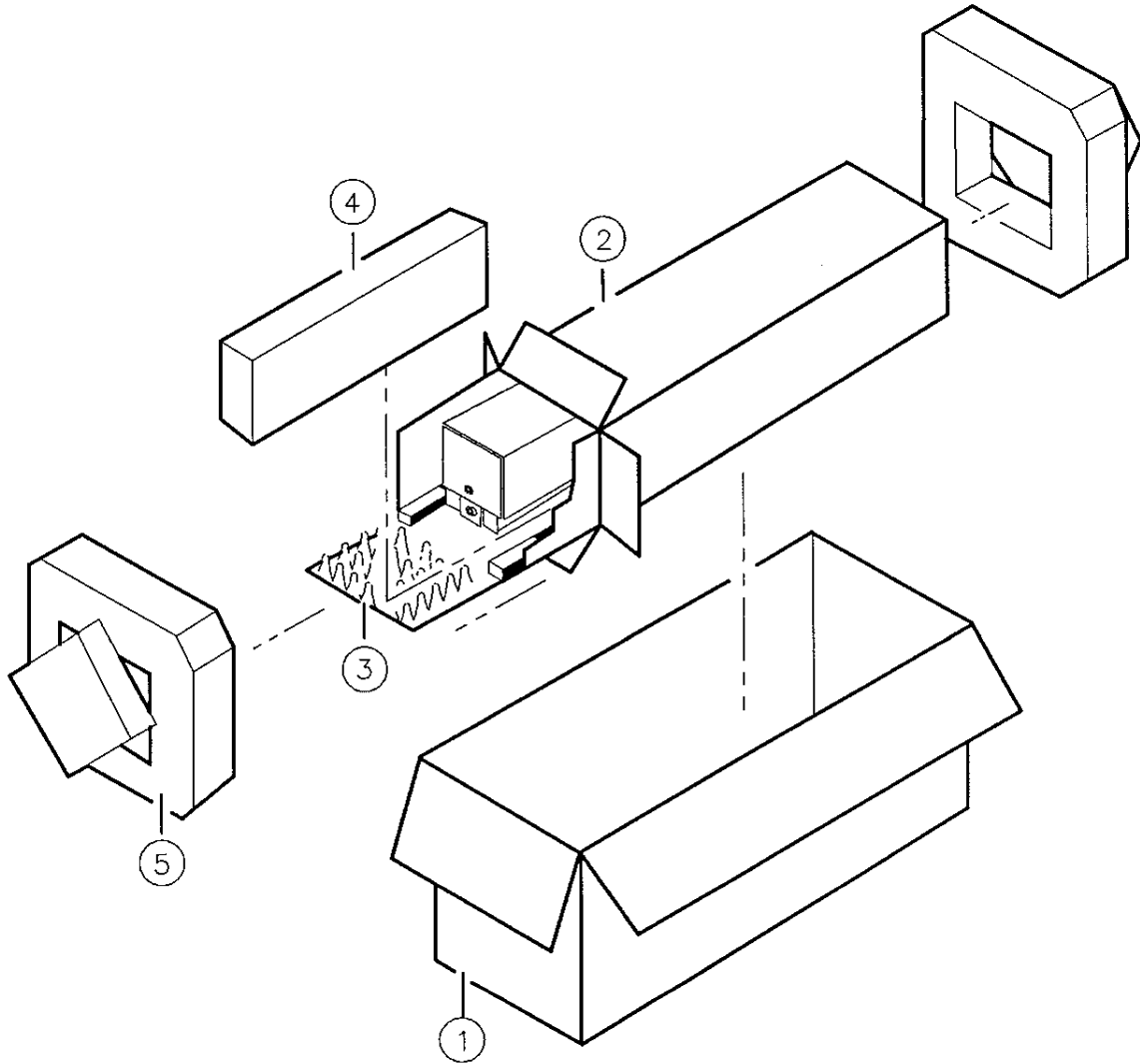

Item	HP Part Number	Qty	Description
1	9211-5118	1	Carton-Outer
2	9211-5119	1	Carton-Inner
3	5180-2369	1	Carton-Slider
4	4208-0493	2	Foam Insert
5	5180-2370	2	Foam Pad

**Figure 1-7. Packaging Materials for Modules**

---

## **Sales and Service Offices**

Hewlett-Packard Sales and Service Offices provide complete support for Hewlett-Packard products. To obtain servicing information, or to order replacement parts, contact the nearest Hewlett-Packard Sales and Service Office listed in Table 1-6.

In any correspondence, be sure to include the pertinent information about model numbers, serial numbers, or assembly part numbers.



**Table 1-6. Hewlett-Packard Sales and Service Offices**

<p><b>IN THE UNITED STATES</b></p> <p><b>California</b> Hewlett-Packard Co. 1421 South Manhattan Ave. P.O. Box 4230 Fullerton, CA 92631 (714) 999-6700</p> <p>Hewlett-Packard Co. 301 E. Evelyn Mountain View, CA 94039 (415) 694-2000</p> <p><b>Colorado</b> Hewlett-Packard Co. 24 Inverness Place, East Englewood, CO 80112 (303) 649-5000</p> <p><b>Georgia</b> Hewlett-Packard Co. 2000 South Park Place P.O. Box 105005 Atlanta, GA 30339 (404) 955-1500</p> <p><b>Illinois</b> Hewlett-Packard Co. 5201 Tollview Drive Rolling Meadows, IL 60008 (312) 255-9800</p> <p><b>New Jersey</b> Hewlett-Packard Co. 120 W. Century Road Paramus, NJ 07653 (201) 265-5000</p> <p><b>Texas</b> Hewlett-Packard Co. 930 E. Campbell Rd. Richardson, TX 75081 (214) 231-6101</p>	<p><b>IN AUSTRALIA</b> Hewlett-Packard Australia Ltd. 31-41 Joseph Street Blackburn, Victoria 3130 895-2895</p> <p><b>IN CANADA</b> Hewlett-Packard (Canada) Ltd. 17500 South Service Road Trans-Canada Highway Kirkland, Quebec H9J 2X8 (514) 697-4232</p> <p><b>IN FRANCE</b> Hewlett-Packard France F-91947 Les Ulis Cedex Orsay (6) 907-78-25</p> <p><b>IN GERMAN FEDERAL REPUBLIC</b> Hewlett-Packard GmbH Vertriebszentrale Frankfurt Berner Strasse 117 Postfach 560 140 D-6000 Frankfurt 56 (0611) 50-04-1</p> <p><b>IN GREAT BRITAIN</b> Hewlett-Packard Ltd. King Street Lane Winnersh, Wokingham Berkshire RG11 5AR 0734 784774</p> <p><b>IN OTHER EUROPEAN COUNTRIES</b> Hewlett-Packard (Schweiz) AG Allmend 2 CH-8967 Widen (Zurich) (0041) 57 31 21 11</p>	<p><b>IN JAPAN</b> Yokogawa-Hewlett-Packard Ltd. 29-21 Takaido-Higashi, 3 Chome Suginami-ku Tokyo 168 (03) 331-6111</p> <p><b>IN PEOPLE'S REPUBLIC OF CHINA</b> China Hewlett-Packard, Ltd. P.O. Box 9610, Beijing 4th Floor, 2nd Watch Factory Main Bldg. Shuang Yu Shu, Bei San Huan Rd. Beijing, PRC 256-6888</p> <p><b>IN SINGAPORE</b> Hewlett-Packard Singapore Pte. Ltd. 1150 Depot Road Singapore 0410 273 7388 Telex HPSGSO RS34209 Fax (65) 2788990</p> <p><b>IN TAIWAN</b> Hewlett-Packard Taiwan 8th Floor, Hewlett-Packard Building 337 Fu Hsing North Road Taipei (02) 712-0404</p> <p><b>IN ALL OTHER LOCATIONS</b> Hewlett-Packard Inter-Americas 3495 Deer Creek Rd. Palo Alto, California 94304</p>
--	---	---



## Installation

---

### Introduction

This chapter contains information needed to configure an HP 70620B or HP 70621A preamplifier in an HP 70000 Modular Measurement System and then check basic module operation. Although the examples in this chapter show an HP 70620B, the same sequence can be used to configure an HP 70621A in an HP 71100C system. For more detailed information about system configuration and addressing, refer to the Installation and Verification Manual for the system master (for example, HP 70900B).

Installing a preamplifier in an HP 70000 Modular Measurement System requires the following steps:

1. Addressing the module.
2. Installing the module into the mainframe.
3. Connecting the front-panel cable.

The configuration examples given in this chapter show address maps and front-panel cable connections for the following configurations:

- HP 70620B configured in front of the RF section in an HP 71200C system. (Refer to Table 1-2, example A, for a simplified block diagram of this configuration.)
- HP 70620B configured in front of the preselected RF section in an HP 71210C system. (Refer to Table 1-2, example B, for a simplified block diagram of this configuration.)
- HP 70620B configured between the preselector and the RF section in an HP 71200C Option 002 system. (Refer to Table 1-2, example C, for a simplified block diagram of this configuration.)

Neither the HP 70620B nor the HP 70621A have rear-panel connections other than the mainframe/module interconnect. When properly installed, modules obtain both power and interface-bus control through the module's rear-panel mainframe/module interconnect.

After the module is installed, use the "Checking Module Operation" section of this chapter to make sure that the module has been properly installed and is not faulty.

Refer to "Accessories" in Chapter 1 for information about cables needed for systems not shown in the configuration examples.

---

**Caution**

To prevent connector damage, and ensure proper electrical connection, all APC-3.5 and SMA connectors must be torqued 7 to 10 inch-pounds. Do not exceed 10 inch-pounds.

---

## Addressing the Module

Modules need an appropriate Hewlett-Packard Modular System Interface Bus (HP-MSIB) address to be able to communicate with the master of the HP 70000 Modular Measurement System. The HP-MSIB address is set using the module's ROW and COLUMN address switches.

**Note** The module can be used in most system configurations without changing the factory-preset address.



### Determining the HP-MSIB Address

Both the HP 70620B and HP 70621A preamplifiers have a factory-preset HP-MSIB address of 3, 19 (row 3, column 19). Figure 2-1 shows the address map for a preamplifier configured in front of the preselected RF section in an HP 71210C system. The addresses in this figure are the factory-preset addresses for the modules. If the preamplifier is going to be used in an HP 70000 Modular Spectrum Analyzer System where the modules all have their factory-preset addresses, the preamplifier probably will not need to have its factory-preset address changed.

However, the preamplifier's factory-preset address may need to be changed if the preamplifier is used between a preselector and the RF section (see Figure 2-8), if the factory-preset addresses of the modules in the system have been changed, or if the preamplifier is being used in another type of HP 70000 Modular Measurement System. For addressing requirements, refer to the Installation and Verification Manual for the system's master.

7			70310A FREQ REF	
6		70908A RF SECT		
5				
4		70903A IF SECT		
3			70620B PREAMP	
2		70902A IF SECT		
1				
0		70900B LO/CTLR HP-1B18		
	17	18	19	20

COLUMN

Figure 2-1. Example of an Address Map

## Setting the HP-MSIB Address Switches

The preamplifier's address switches are located on the left side of the module. Table 2-1 gives the decimal value for each address switch when the switch is set to binary 1 (on).

**Table 2-1. Decimal Equivalents of Row and Column Address Switches**

Address Switch	Decimal Value
<b>Row</b>	
3	4
2*	2
1*	1
<b>Column</b>	
5*	16
4	8
3	4
2*	2
1*	1
*These switches are factory-preset to binary 1 (on), resulting in an HP-MSIB address of 3, 19 (row 3, column 19).	

Use the procedure below to change the address switches:

1. Set the three ROW switches to the binary value of the module's HP-MSIB row number. For example, if the row number is 3, change the switches to binary 011 as shown in Figure 2-2.
2. Set the five COLUMN switches to the binary value of the module's HP-MSIB column number. For example, if the column number is 19, change the switches to binary 10011 as shown in Figure 2-2.

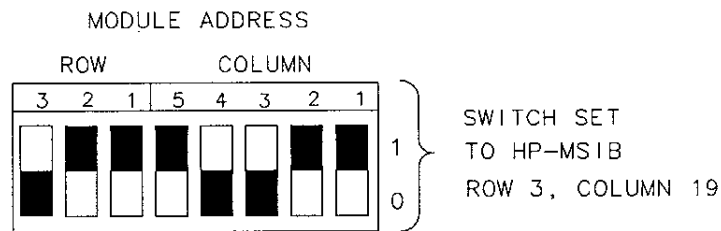

**Figure 2-2. Address Switches**

---

## Installing the Module in the Mainframe

The preamplifier module needs to be installed in an HP 70000 Modular Measurement System mainframe before it will operate. Follow the procedure below to install a module into the mainframe. See Figure 2-3 for identification of the module and mainframe parts called out in the procedure.

1. Turn the mainframe LINE switch off.
2. Open the mainframe front-panel door.
3. Slide the module into the mainframe.
4. Press against the module front panel while tightening the module latch with an 8 mm hex-ball driver.
5. Close the mainframe front-panel door.
6. Turn the mainframe LINE switch on.

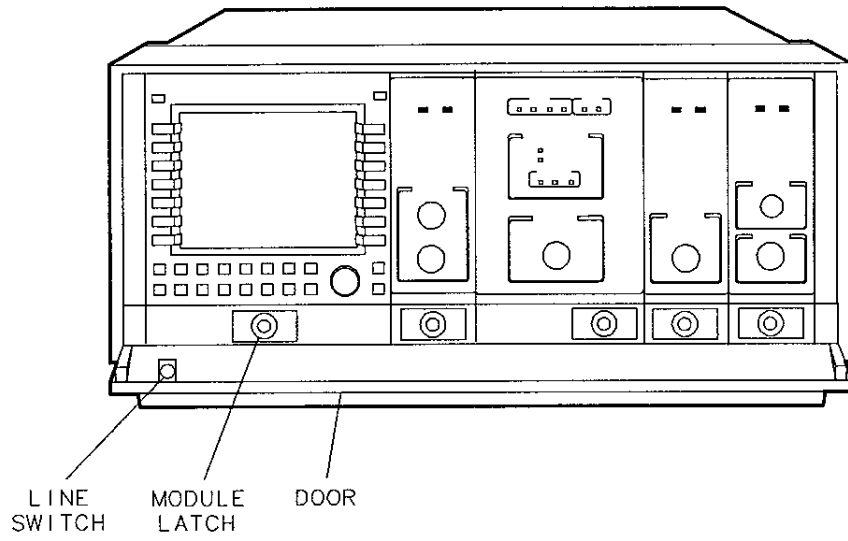

**Figure 2-3. Module Installation in Mainframe**

## Configuring an HP 70620B in an HP 71200C System

The system shown in Figures 2-4 and 2-5 contains the following equipment. The preamplifier is configured in front of the RF section, as shown in Table 1-2, example A.

HP 70620B Preamplifier

HP 71200C Microwave Spectrum Analyzer, which consists of the following:

HP 70001A Mainframe

HP 70004A Display

HP 70310A Precision Frequency Reference

HP 70900B Local Oscillator

HP 70902A IF Section

HP 70905A RF Section

R O W	7			70310A FREQ REF	
	6		70905A RF SECT		
	5				
	4				
	3			70620B PREAMP	
	2		70902A IF SECT		
	1				
	0		70900B LO/CTLR HP-1B18		
		17	18	19	20
		COLUMN			

Figure 2-4. Address Map Showing HP 70620B in HP 71200C System



Connect the HP 70620B RF OUTPUT to the HP 70905A RF INPUT using an SMA (f) to Type N (m) cable (HP part number 5022-0003). Figure 2-5 illustrates the cable connection.

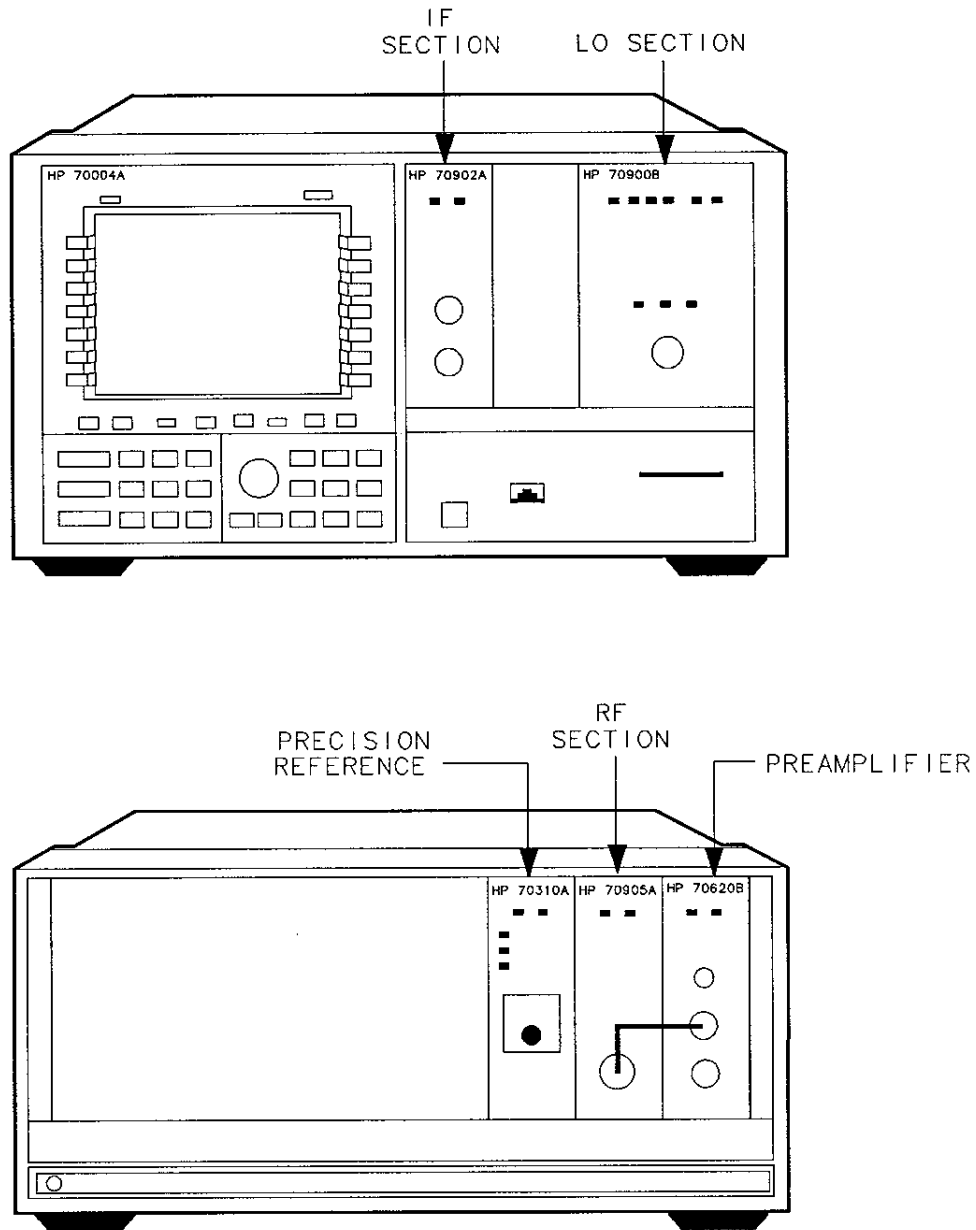

Figure 2-5. Front-Panel Cabling for HP 70620B in HP 71200C System

## Configuring an HP 70620B in an HP 71210C System

The system shown in Figures 2-6 and 2-7 contains the following equipment. The preamplifier is configured in front of a preselector (the HP 70908A is a preselected RF section), as shown in Table 1-2, example B.

HP 70620B Preamplifier

HP 71210C High Sensitivity Microwave Spectrum Analyzer, which consists of the following:

HP 70001A Mainframe

HP 70004A Display

HP 70310A Precision Frequency Reference

HP 70900B Local Oscillator

HP 70902A IF Section

HP 70903A IF Section

HP 70908A RF Section

R O W	7			70310A FREQ REF	
	6		70908A RF SECT		
	5				
	4		70903A IF SECT		
	3			70620B PREAMP	
	2		70902A IF SECT		
	1				
	0		70900A LO/CTLR HP-1B18		
		17	18	19	20
		COLUMN			

Figure 2-6. Address Map Showing HP 70620B in HP 71210C System

Connect the HP 70620B RF OUTPUT to the HP 70908A RF INPUT using a SMA (f) to Type N (m) cable (HP part number 5021-9952). Figure 2-7 illustrates the cable connection.

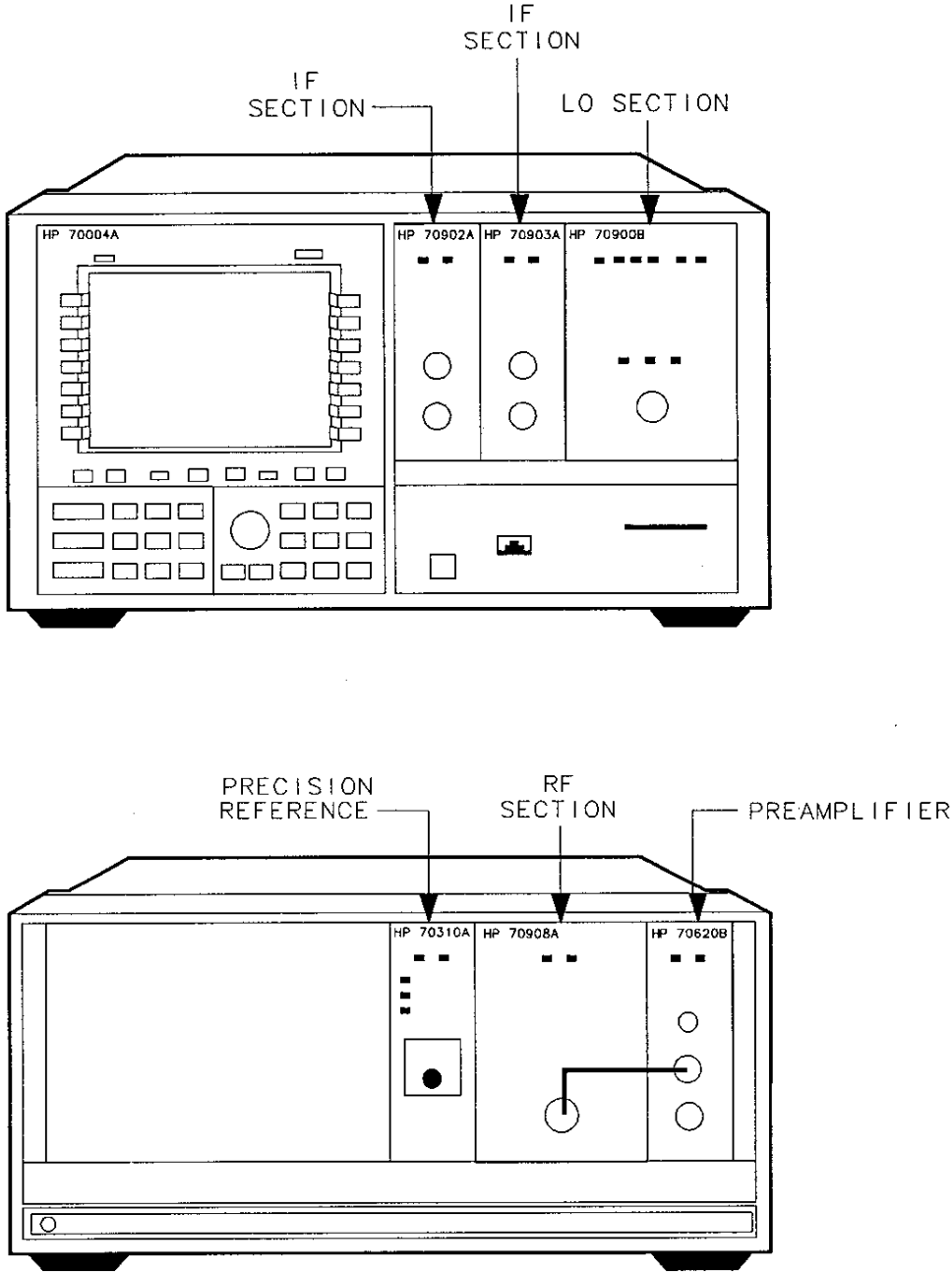

Figure 2-7. Front-Panel Cabling for HP 70620B in HP 71210C System

## Configuring an HP 70620B in an HP 71200C Option 002 System

The system shown in Figures 2-8 and 2-9 contains the following equipment. The preamplifier is configured between the preselector and the RF section, as shown in Table 1-2, example C.

HP 70620B Preamplifier

HP 71210C Option 002 Microwave Spectrum Analyzer, which consists of the following:

HP 70001A Mainframe

HP 70004A Display

HP 70310A Precision Frequency Reference

HP 70900B Local Oscillator

HP 70902A IF Section

HP 70905B RF Section

HP 70600A Preselector

### Note



Because the preamplifier is configured between the preselector and the RF section, the preamplifier's factory-preset HP-MSIB address must be changed. The example below uses a preamplifier HP-MSIB address of 1, 19 (row 1, column 19).

A system with an additional preamplifier in front of the HP 70600 would be at address 3, 19. For an explanation of HP-MSIB addressing requirements, refer to the Installation and Verification Manual for the system's master.

R O W	7		70310A FREQ REF		
	6		70905B RF SECT		
	5				
	4				
	3				
	2		70902A IF SECT	70600A PRE SEL	
	1			70620B PREAMP	
	0		70900B LO/CTLR HP-1B18		
		17	18	19	20
		COLUMN			

Figure 2-8. Address Map Showing HP 70620B in HP 71200C Option 002 System

Figure 2-9 illustrates the cable connections. Use the following steps to connect the preamplifier:

- Connect the HP 70620B RF OUTPUT to the HP 70905B RF INPUT using an APC-3.5 (f) to SMA (m) cable (HP part number 5022-0064).
- Connect the HP 70620B RF INPUT to the HP 70600A RF OUTPUT using an APC-3.5 (f) to SMA (m) cable (HP part number 5022-0064).

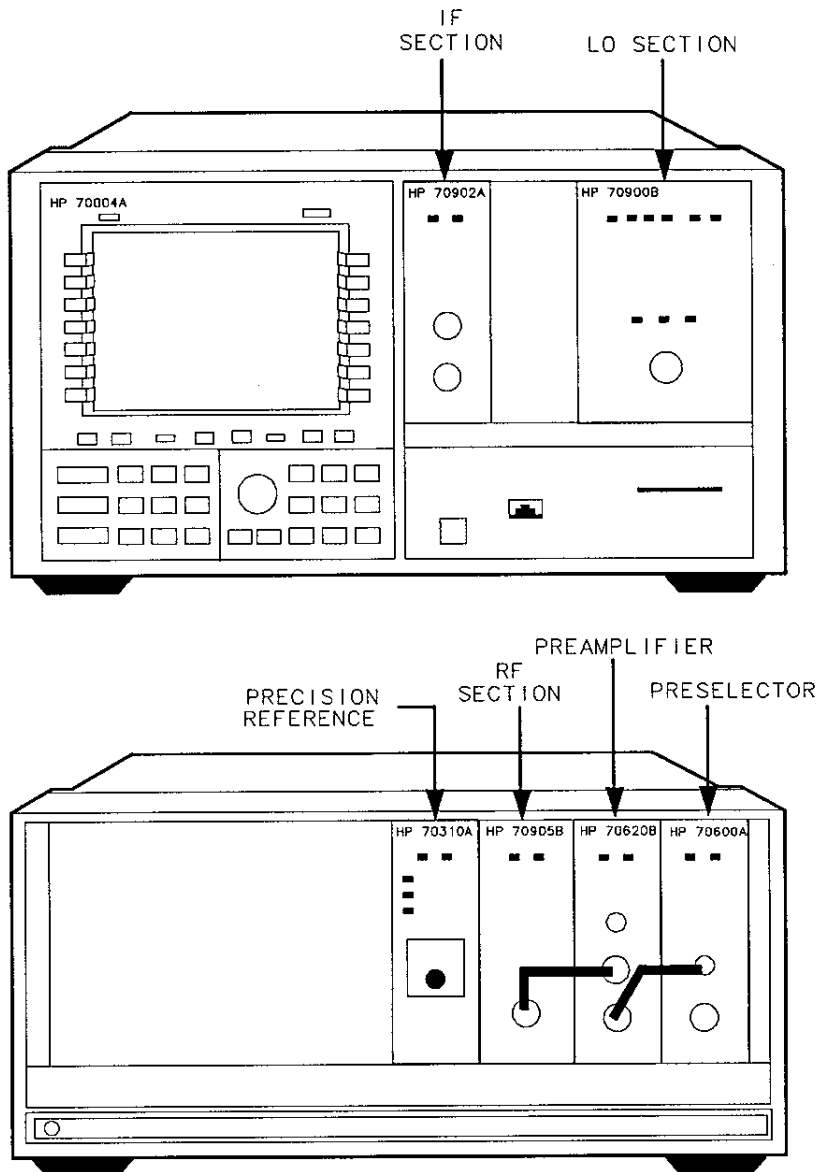

Figure 2-9. Front-Panel Cabling for HP 70620B in HP 71200C Option 002 System

---

## Checking Module Operation

The operation of the preamplifier in an HP 70000 Modular Spectrum Analyzer system is checked by examining the front-panel LEDs, checking for error messages after the module's power-on self-test has run, and measuring the +28 VDC OUT voltage.

### Examining the Front-Panel LEDs

The power-on self-test runs automatically when power is first applied to the module. The front-panel LEDs flash on and then off during the self-test. Immediately after the self-test has run, the ERR LED should be *off*. Refer to Chapter 5, "Troubleshooting," if the ERR LED is on.

### Checking for Error Messages

Perform this procedure to display any error messages present for the system.

1. Press **DISPLAY**, then **REPORT ERRORS**.
2. The error messages for the system will be visible on the display screen. The error message consists of the module model number, the error code, and the module's HP-MSIB address. Note any error messages that have 70620B or 70621A as part of the error message. The last two numbers of the error message are the module's HP-MSIB address (3, 19) and will be different if the factory-preset address has been changed.
3. If any error messages are displayed, refer to Chapter 5 for troubleshooting information. If no error messages are present, and the +28 VDC OUT voltage is correct, the preamplifier is operating properly.

### Measuring the +28 VDC OUT Voltage

Use the test given in Chapter 4, "Verification," to check the +28 VDC OUT voltage. If the voltage is incorrect refer to Chapter 5, "Troubleshooting."

## Specifications

---

### Introduction

This chapter contains module specifications and characteristics for the HP 70620B and HP 70621A preamplifiers. For system specifications, refer to the system master's Installation and Verification Manual.

This chapter contains both specifications and characteristics. Characteristics are in *italics* and are identified with the word *characteristic*. The terms "specifications" and "characteristics" are defined below:

**Specifications** describe warranted performance over the temperature range of 0°C to +55°C (unless otherwise noted) after 1 hour of continuous operation. Specifications apply after system temperatures have stabilized and self-calibration routines have run.

Unless otherwise noted, corrected limits are given when a specification range is improved with error-correction routines. All specifications that are qualified by an output-power setting refer to that setting.

**Typical performance**, where listed, is *not warranted*, but indicates performance which most units will meet.

**Characteristics** provide useful, but *nonwarranted*, functional and performance information.

**Nominal values** indicate the expected, but *nonwarranted*, value of the denoted parameter.

---

## Module Specifications and Characteristics

### +28 VDC OUT

The +28 VDC OUT connector is a BNC (f) in both HP 70620B and HP 70621A modules.

#### Output Voltage

while in "On" state, $\leq 60$ mA	.....+28 V dc $\pm 0.1$ V dc
while in "Off" state	..... <1 V

### RF OUTPUT

The RF OUTPUT connector is an APC-3.5 (m) in the HP 70620B and an SMA (f) in the HP 70621A.

#### Reverse isolation (characteristic)

reduces spectrum analyzer LO emissions

HP 70620B	..... > 75 dB
HP 70620B Option 001	
100 kHz to 2.9 GHz	..... > 50 dB
2.7 GHz to 26.5 GHz	..... > 75 dB
HP 70621A	..... > 50 dB

#### Gain compression (characteristic)

<1 dB for the following preamplifier output signals:

HP 70620B output signal	..... $\leq +7$ dBm
HP 70620B Option 001 output signal	
100 kHz to 2.9 GHz	..... $\leq 0$ dBm
2.7 GHz to 26.5 GHz	..... $\leq +7$ dBm
HP 70621A output signal	..... $\leq 0$ dBm

Second Harmonic Distortion Intercept (characteristic) .....  $\geq +30$  dBm

#### Third-Order Intercept (characteristic)

HP 70620B	..... $\geq +15$ dBm
HP 70620B Option 001	
100 kHz to 2.9 GHz	..... $\geq 0$ dBm
2.7 GHz to 26.5 GHz	..... $\geq +15$ dBm
HP 70621A	..... $\geq 0$ dBm

Impedance .....  $50\Omega$  nominal

#### Gain (characteristic)

Applies only when module is in preamplifier mode and temperature is 20°C to 30°C.

HP 70620B	
1 GHz to 12.7 GHz	..... $\geq 26$ dB
12.7 GHz to 26.5 GHz	..... $\geq 24$ dB
HP 70620B Option 001	
100 kHz to 2.9 GHz	..... $\geq 22$ dB
2.7 GHz to 12.7 GHz	..... $\geq 25$ dB
12.7 GHz to 22 GHz	..... $\geq 23$ dB
22 GHz to 26.5 GHz	..... $\geq 20$ dB
HP 70621A	
100 kHz to 2.9 GHz	..... $\geq 24$ dB



*Bypass Insertion Loss (characteristic)*

Applies only when module is in bypass mode.

**HP 70620B**

0 Hz to 2.9 GHz	≤ 1 dB
2.9 GHz to 12.7 GHz	≤ 1.8 dB
12.7 GHz to 26.5 GHz	≤ 2.5 dB

**HP 70620B Option 001**

0 Hz to 2.9 GHz	≤ 1 dB
2.7 GHz to 12.7 GHz	≤ 1.8 dB
12.7 GHz to 26.5 GHz	≤ 2.5 dB

**HP 70621A**

0 Hz to 2.9 GHz	≤ 1 dB
0 Hz to 26.5 GHz	≤ 6 dB

*Noise Figure (characteristic)*

(20°C to 30°C)

**HP 70620B**

1 GHz to 12.7 GHz	≤ 9.0 dB
12.7 GHz to 22.0 GHz	≤ 13.0 dB
22 GHz to 26.5 GHz	≤ 15.0 dB

**HP 70620B Option 001**

100 kHz to 2.9 GHz	≤ 7.5 dB
2.7 GHz to 12.7 GHz	≤ 9.5 dB
12.7 GHz to 22.0 GHz	≤ 14.0 dB
22 GHz to 26.5 GHz	≤ 16.0 dB

**HP 70621A**

100 kHz to 2.9 GHz	≤ 6.0 dB
--------------------	----------

*VSWR (characteristic)*

**HP 70620B**

**Preamplifier Mode**

1 GHz to 12.7 GHz	2.0:1
12.7 to 26.5 GHz	2.2:1

**Bypass Mode**

0 Hz to 2.7 GHz	1.3:1
2.7 to 12.7 GHz	1.7:1
12.7 to 26.5 GHz	2.4:1

**HP 70620B Option 001**

**Preamplifier Mode**

100 kHz to 2.9 GHz	2.4:1
2.7 to 12.7 GHz	2.2:1
12.7 to 26.5 GHz	3.0:1

**Bypass Mode**

0 Hz to 2.9 GHz	1.3:1
2.7 to 12.7 GHz	1.7:1
12.7 to 26.5 GHz	2.4:1

**HP 70621A**

<b>Preamplifier Mode (100 kHz to 2.9 GHz)</b>	1.9:1
<b>Bypass Mode (0 Hz to 2.9 GHz)</b>	1.3:1

## RF INPUT

The RF INPUT connector is an APC-3.5 (m) in an HP 70620B and a Type N (f) in an HP 70621A.

### Maximum safe input power (characteristic)

Preamplifier mode	+20 dBm (100 mW)
Bypass mode	This is specific to the RF section in the system. Refer to the appropriate RF section Installation and Verification Manual.

### Maximum dc input

HP 70620B	±20 V dc
HP 70620B Option 001	±10 V dc
HP 70621A	±20 V dc

Impedance ..... 50Ω nominal

### VSWR (characteristic)

#### HP 70620B

##### Preamplifier Mode

1 GHz to 2.7 GHz	2.2:1
2.7 to 12.7 GHz	1.6:1
12.7 to 26.5 GHz	2.8:1

##### Bypass Mode

0 Hz to 2.7 GHz	1.3:1
2.7 to 12.7 GHz	1.7:1
12.7 to 26.5 GHz	2.4:1

#### HP 70620B Option 001

##### Preamplifier Mode

100 kHz to 2.9 GHz	2.4:1
2.7 to 12.7 GHz	2.2:1
12.7 to 26.5 GHz	3.0:1

##### Bypass Mode

0 Hz to 2.9 GHz	1.3:1
2.7 to 12.7 GHz	1.7:1
12.7 to 26.5 GHz	2.4:1

#### HP 70621A

Preamplifier Mode (100 kHz to 2.9 GHz)	2.0:1
Bypass Mode (0 Hz to 2.9 GHz)	1.3:1

---

## General Specifications and Characteristics

### Temperature

Operation ..... 0°C to +55°C

Storage ..... -40°C to +75°C

### Weight (characteristic)

HP 70620B ..... 1.8 kg (4 lb)

HP 70620B Option 001 ..... 2.5 kg (5.5 lb)

HP 70621A ..... 1.8 kg (4 lb)

Dimensions (characteristic) ..... 1/8-width module

12

## Verification

---

### Introduction

This chapter contains the test necessary to verify the +28 VDC OUT voltage specifications. The system-level performance specifications for the preamplifier are in the Installation and Verification Manual for the system master (for example, HP 70900B Local Oscillator). System-level testing of systems controlled by an HP 70900 local oscillator can be accomplished in two ways:

- Run the system operation-verification tests, using revision C.00.01 or greater. (For system operation verification, refer to the Installation and Verification Manual for the system's master.)
- Run the HP 11990A system tests, using revision C.00.01 or greater. The HP 11990A software and documentation are available through Hewlett-Packard Sales Offices.

System-level testing of systems controlled by other system masters can be accomplished by using the system operation-verification tests given in the Installation and Verification Manual for that system master. HP 11990 Series system tests can also be used, if they are available for that system master.

---

---

## +28 VDC OUT Test

Use either the manual or remote test to verify that the preamplifier's +28 V dc noise-source drive voltage meets specifications. Refer to Table 4-1 for equipment requirements.

**Table 4-1. Equipment Requirements for +28 VDC OUT Test**

Equipment	Requirements	HP Model or Part Number
Voltmeter	accuracy better than 0.1 V dc	HP 3456A
HP 70000 series system	system master is HP 70900 local oscillator	
Computer	HP-IB Control	HP 9000 Series 200/300
Cable	BNC (m) to BNC (m)	HP 10503A or equivalent
Adapter	BNC (f) to dual banana plug	1251-2277 or equivalent

---

### Note



The local oscillator will generate error messages if it cannot establish communications with the module. If this occurs, make sure that the following conditions exist:

- The address of the local oscillator controlling the system matches the address called out in the procedure below.
- The preamplifier module is correctly addressed in the system controlled by the local oscillator.

---

### Manual Test

Install the preamplifier in an appropriate HP 70000 series system. (Refer to "Firmware Compatibility" in Chapter 1.)

1. Set the voltmeter to measure dc volts.
2. Connect the voltmeter to +28 VDC OUT.
3. Press **State MORE preamp control NOISE On**.
4. The voltage should measure +28 V dc  $\pm 0.1$  V dc.
5. Press **NOISE Off**.
6. The voltage should measure less than 1 V dc.

### Remote Test

Install the preamplifier in an HP 70000 series system, and connect the HP 70000 series system to the computer via HP-IB. The procedure below assumes that the system master's HP-IB address is 18, and that the HP-IB interface select code is 7. This results in a remote address of 718. If either the system master's HP-IB address or the HP-IB interface select code are different than those listed, modify the following steps to reflect the actual address:

1. Set the voltmeter to measure dc volts.
2. Connect the voltmeter to +28 VDC OUT.
3. Execute the following command: `OUTPUT 718; "XNOISE ON;"`
4. The voltage should measure +28 V dc  $\pm 0.1$  V dc.
5. Execute the following command: `OUTPUT 718; "XNOISE OFF;"`
6. The voltage should measure less than 1 V dc.





## Troubleshooting

---

### Introduction

This chapter contains information about HP 70620B and HP 70621A front-panel LEDs and a listing of the error codes for the HP 70620B and HP 70621A. The information in this chapter is designed to help determine whether an error is being caused by the preamplifier (HP 70620B or HP 70621A). For more detailed preamplifier troubleshooting information, refer to the *HP 70620B/HP 70621A Preamplifier Service Manual*.

If the error is not caused by the preamplifier, refer to the Installation and Verification Manual for the system master (for example, HP 70900B) for more troubleshooting information.

---

### +28 VDC OUT Failure

Use the +28 VDC OUT test in Chapter 4 to measure the voltage. If the test fails, then the preamplifier module is faulty. Refer to the *HP 70620B/HP 70621A Preamplifier Service Manual* for more troubleshooting information.

---

### Front-Panel LEDs

The preamplifiers each have two front-panel LEDs. Both of the front-panel LEDs flash on, then off again, during the module's self-test. Listed below are the other reasons for each LED to light:

- The ACT (active) LED lights when the module has is being activated by an HP 70000 Modular System master that has an active keyboard link. If there is no display in the system, the ACT LED will not light.
- The ERR (error) LED lights when there is an error condition. If the ERR LED blinks at a 1-Hz rate, there is a problem with communication over the HP-MSIB. If the ERR LEDs of all the modules in a system are blinking at a 1-Hz rate, refer to the Installation and Verification Manual for the system master. It is possible for a module to disrupt the HP-MSIB and *not* have its ERR LED blink.

---

## Error Messages

An error message usually consists of the model number of the affected module, an error code, and the module HP-MSIB address. The error codes generated by the preamplifiers (HP 70620B and HP 70621A) are listed below in numerical order. For a complete list of all system error messages, refer to the Installation and Verification Manual for the system master.

Error Types	Error Numbers
Usage/Operating .....	2000 to 2999
Hardware Warning .....	6000 to 6999
Hardware Broken .....	7000 to 7999

### Usage/Operating Errors

These errors occur when the instrument is used incorrectly.

- 2001 **Illegal cmd** — This error usually occurs in response to a user-generated system protocol error: the module has encountered a command that it does not recognize. This can be caused by the system master's sending such a command; however, if the error is repeated when the module is moved to another mainframe, the most probable cause is faulty preamplifier hardware.
- 2002 **Illegal parameter** — Refer to 2001 Illegal Cmd.
- 2006 **Param out of range** — Refer to 2001 Illegal Cmd.
- 2009 **Protocol error** — Refer to 2001 Illegal Cmd.

### Hardware Warning Errors

These error codes report the status of the preamplifier hardware or indicate that some of the hardware may be broken. These error codes indicate that measurement accuracy may be impaired.

- 6000 **EAROM unprotected** — The module's write-protect switch is set to the write position. If this error occurs when the switch is in the protect position, the most probable cause is faulty preamplifier hardware.

### Hardware-Broken Messages

The following error codes are generated in response to hardware or firmware failures within the modules.

- 7000 **ROM Check error** — A test of the module ROM has failed. The most probable cause is faulty preamplifier hardware.

# Index

---

## A

- accessories
  - adapter, 1-10
  - cables, 1-10
  - electrostatic discharge, 1-13
  - noise source, 1-10
- ACT LED, 1-8
- address map, 2-2
- address switches
  - decimal value, 2-3
  - location, 2-3
  - setting, 2-3
- application examples, 1-6

## B

- bypass mode, 1-4

## C

- configuration examples, 1-6

## E

- ERR LED, 1-8
- error codes, 5-2
- error lights, 1-8, 5-1
- ESD (electrostatic discharge), 1-11–13

## F

- frequency range, 1-3

## H

- HP 70620B
  - frequency range, 1-3
  - inputs and outputs, 3-2
- HP 70621A
  - frequency range, 1-3
  - inputs and outputs, 3-2
- HP-MSIB, 1-8
  - address, 2-2

## I

- inputs and outputs, 1-8

## L

- LEDs, 1-8, 5-1
- LO firmware version, 1-5
  - module option 098, 1-5
  - module option 099, 1-5

## M

- module configuration, 2-1
- module errors, 5-2
- module-operation checks, 2-12

## N

- noise-figure measurement, 1-3
- noise-source drive
  - output voltage specification, 3-2
  - remote commands, 4-2
  - verification test, 4-2
  - voltage, 1-3

## P

- packaging, 1-14
- PC board connector cleaning, 1-12
- preamplifier
  - HP-MSIB address, 2-2
  - inputs and outputs, 1-8
  - installing in mainframe, 2-4
  - mode, 1-4
  - used with microwave preselector, 1-6
- preselector, 1-6, 2-8, 2-10

## S

- sales and service offices, 1-16
- serial-number label, 1-2
- shipping materials, 1-15
- static-safe work station, 1-11
- status and error LEDs, 1-8, 5-1
- system-level testing, 4-1

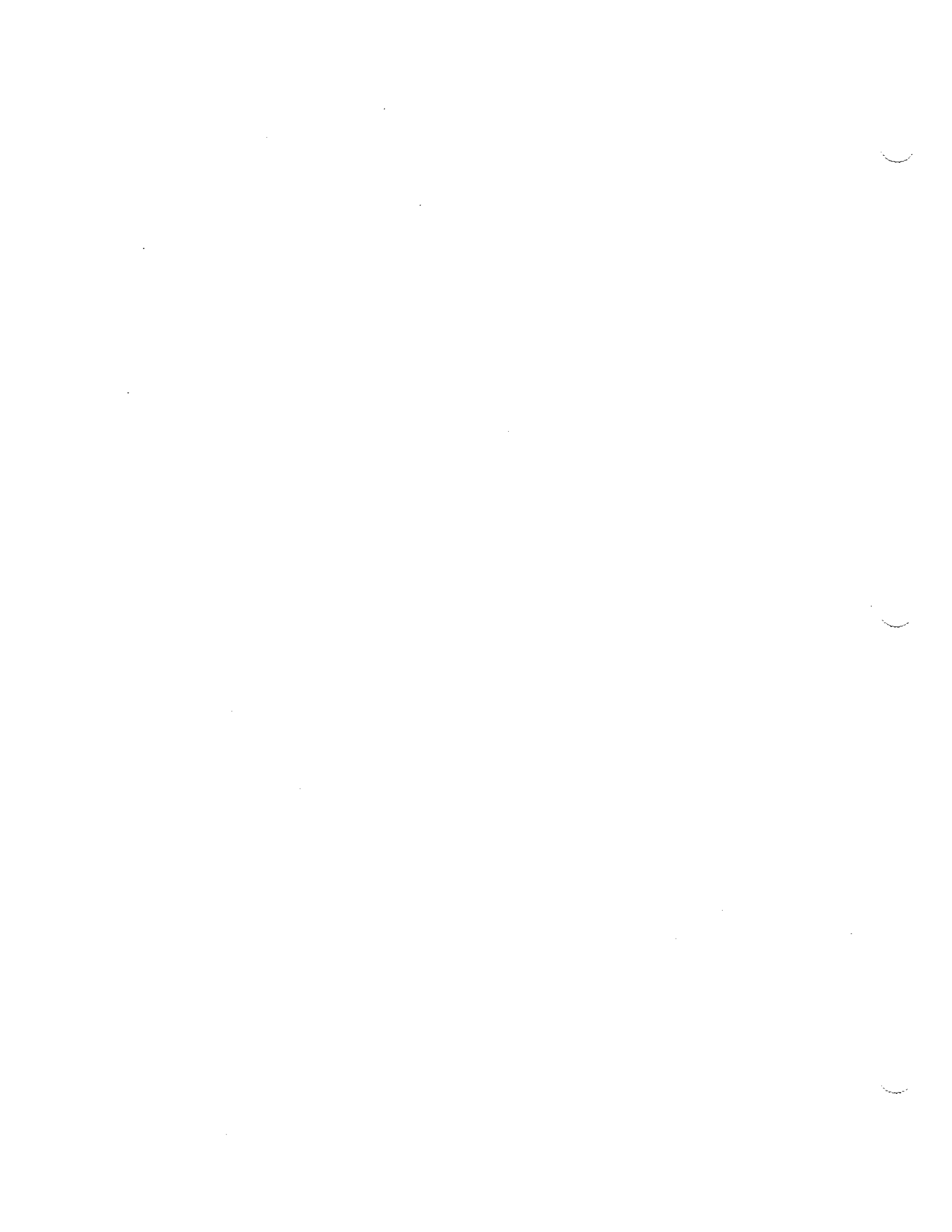

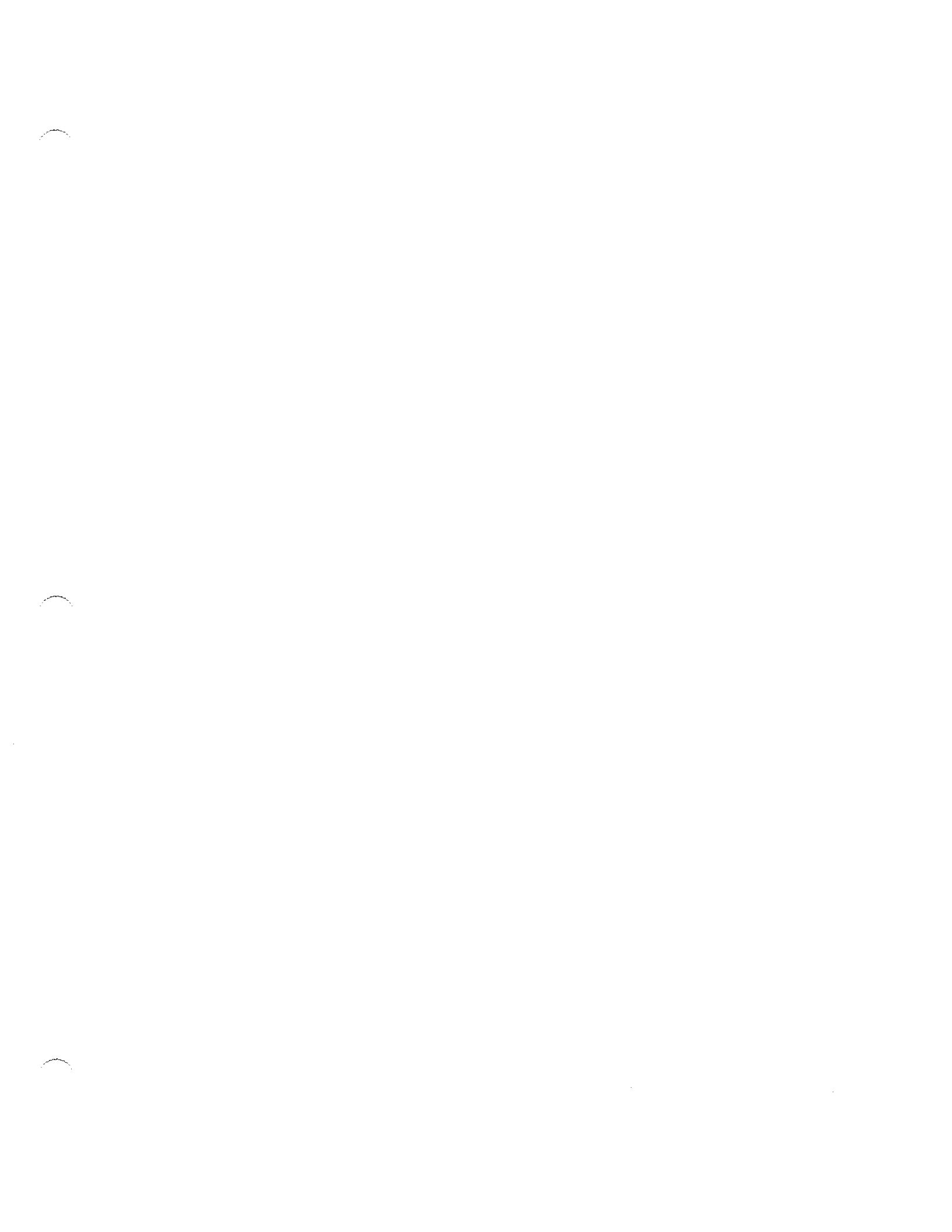



HP Part No. 70620-90022  
Printed in USA

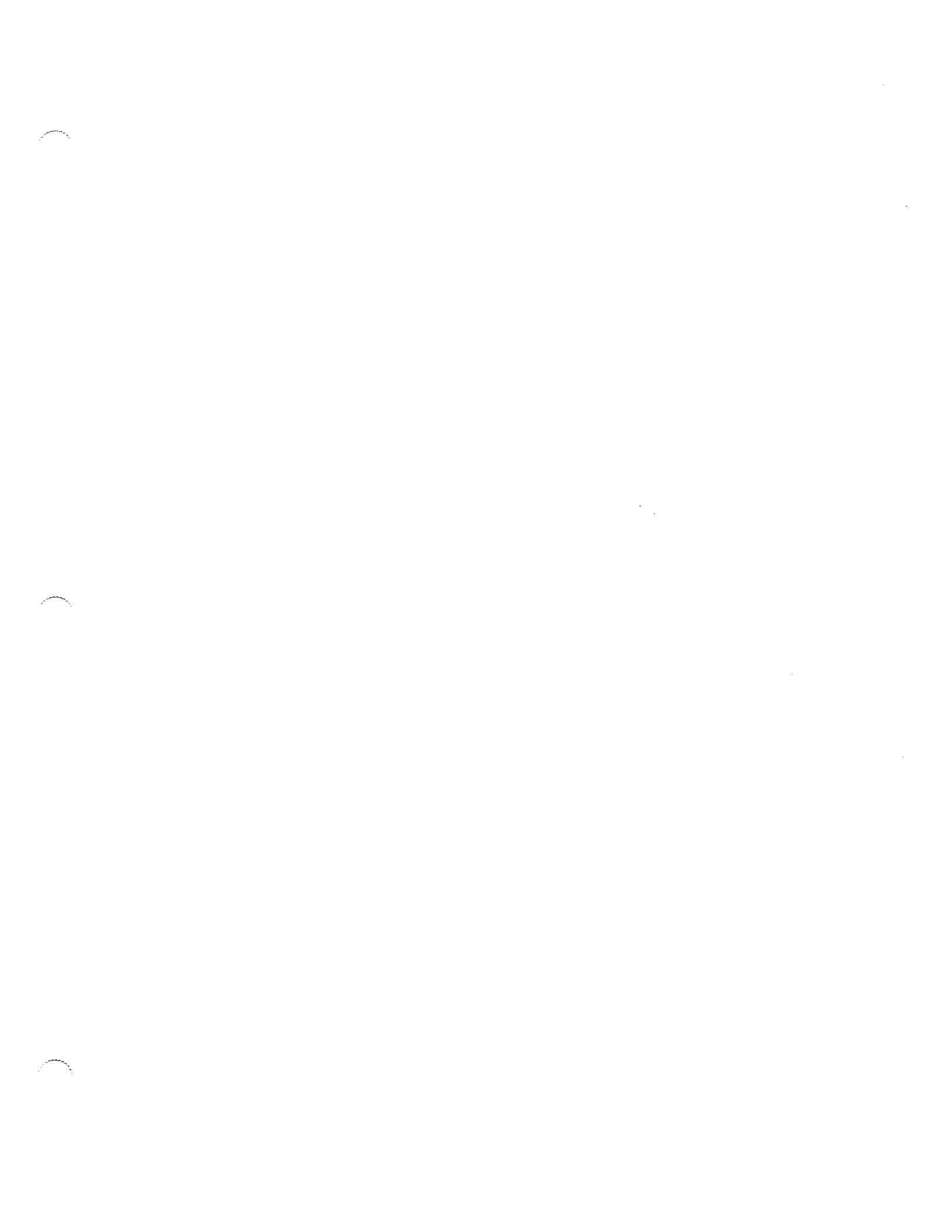

**MP MASTER**



MA27073

**\*\* For HP Internal Reference Only \*\***

Customer Order Number

Manufacturing Part Number

**70620-90022**



Printed in USA