

About this Manual

We've added this manual to the Agilent website in an effort to help you support your product. This manual is the best copy we could find; it may be incomplete or contain dated information. If we find a more recent copy in the future, we will add it to the Agilent website.

Support for Your Product

Agilent no longer sells or supports this product. Our service centers may be able to perform calibration if no repair parts are needed, but no other support from Agilent is available. You will find any other available product information on the Agilent Test & Measurement website, www.tm.agilent.com.

HP References in this Manual

This manual may contain references to HP or Hewlett-Packard. Please note that Hewlett-Packard's former test and measurement, semiconductor products and chemical analysis businesses are now part of Agilent Technologies. We have made no changes to this manual copy. In other documentation, to reduce potential confusion, the only change to product numbers and names has been in the company name prefix: where a product number/name was HP XXXX the current name/number is now Agilent XXXX. For example, model number HP8648A is now model number Agilent 8648A.

Installation and Verification Guide

HP 70300A

RF Tracking Generator



**HP Part No. 70300-90107
Printed in USA March 1995**

Edition A.0.0

Notice

The information contained in this document is subject to change without notice.

Hewlett-Packard makes no warranty of any kind with regard to this material, including, but not limited to, the implied warranties of merchantability and fitness for a particular purpose. Hewlett-Packard shall not be liable for errors contained herein or for incidental or consequential damages in connection with the furnishing, performance, or use of this material.

Restricted Rights Legend.

Use, duplication, or disclosure by the U.S. Government is subject to restrictions as set forth in subparagraph (c) (1) (ii) of the Rights in Technical Data and Computer Software clause at DFARS 252.227-7013 for DOD agencies, and subparagraphs (c) (1) and (c) (2) of the Commercial Computer Software Restricted Rights clause at FAR 52.227-19 for other agencies.

©Copyright Hewlett-Packard Company 1992, 1995

All Rights Reserved. Reproduction, adaptation, or translation without prior written permission is prohibited, except as allowed under the copyright laws.
1400 Fountaingrove Parkway, Santa Rosa, CA 95403-1799, USA

Certification

Hewlett-Packard Company certifies that this product met its published specifications at the time of shipment from the factory. Hewlett-Packard further certifies that its calibration measurements are traceable to the United States National Institute of Standards and Technology, to the extent allowed by the Institute's calibration facility, and to the calibration facilities of other International Standards Organization members.

Warranty

This Hewlett-Packard instrument product is warranted against defects in material and workmanship for a period of one year from date of shipment. During the warranty period, Hewlett-Packard Company will, at its option, either repair or replace products which prove to be defective.

For warranty service or repair, this product must be returned to a service facility designated by Hewlett-Packard. Buyer shall prepay shipping charges to Hewlett-Packard and Hewlett-Packard shall pay shipping charges to return the product to Buyer. However, Buyer shall pay all shipping charges, duties, and taxes for products returned to Hewlett-Packard from another country.

Hewlett-Packard warrants that its software and firmware designated by Hewlett-Packard for use with an instrument will execute its programming instructions when properly installed on that instrument. Hewlett-Packard does not warrant that the operation of the instrument, or software, or firmware will be uninterrupted or error-free.

LIMITATION OF WARRANTY

The foregoing warranty shall not apply to defects resulting from improper or inadequate maintenance by Buyer, Buyer-supplied software or interfacing, unauthorized modification or misuse, operation outside of the environmental specifications for the product, or improper site preparation or maintenance.

NO OTHER WARRANTY IS EXPRESSED OR IMPLIED. HEWLETT-PACKARD SPECIFICALLY DISCLAIMS THE IMPLIED WARRANTIES OF MERCHANTABILITY AND FITNESS FOR A PARTICULAR PURPOSE.

EXCLUSIVE REMEDIES

THE REMEDIES PROVIDED HEREIN ARE BUYER'S SOLE AND EXCLUSIVE REMEDIES. HEWLETT-PACKARD SHALL NOT BE LIABLE FOR ANY DIRECT, INDIRECT, SPECIAL, INCIDENTAL, OR CONSEQUENTIAL DAMAGES, WHETHER BASED ON CONTRACT, TORT, OR ANY OTHER LEGAL THEORY.

Assistance

Product maintenance agreements and other customer assistance agreements are available for Hewlett-Packard products.

For any assistance, contact your nearest Hewlett-Packard Sales and Service Office.

Safety Symbols

The following safety symbols are used throughout this manual. Familiarize yourself with each of the symbols and its meaning before operating this instrument.

CAUTION The *CAUTION* sign denotes a hazard. It calls attention to a procedure which, if not correctly performed or adhered to, could result in damage to or destruction of the product or the user's work. Do not proceed beyond a *CAUTION* sign until the indicated conditions are fully understood and met.

WARNING The *WARNING* sign denotes a hazard. It calls attention to a procedure which, if not correctly performed or adhered to, could result in injury to the user. Do not proceed beyond a *WARNING* sign until the indicated conditions are fully understood and met.

DANGER The *DANGER* sign denotes an imminent hazard to people. It warns the reader of a procedure which, if not correctly performed or adhered to, could result in injury or loss of life. Do not proceed beyond a *DANGER* sign until the indicated conditions are fully understood and met.

General Safety Considerations

- WARNING**
- The instructions in this document are for use by qualified personnel only. To avoid electrical shock, do not perform any servicing unless you are qualified to do so.
 - The opening of covers or removal of parts is likely to expose dangerous voltages. Disconnect the instrument from all voltage sources while it is being opened.
 - The power cord is connected to internal capacitors that may remain live for five seconds after disconnecting the plug from its power supply.
 - This is a Safety Class 1 Product (provided with a protective earthing ground incorporated in the power cord). The mains plug shall only be inserted in a socket outlet provided with a protective earth contact. Any interruption of the protective conductor inside or outside of the instrument is likely to make the instrument dangerous. Intentional interruption is prohibited.
 - For continued protection against fire hazard, replace fuse only with same type and ratings, (type nA/nV). The use of other fuses or materials is prohibited.
-

- WARNING**
- Before this instrument is switched on, make sure it has been properly grounded through the protective conductor of the ac power cable to a socket outlet provided with protective earth contact.

Any interruption of the protective (grounding) conductor, inside or outside the instrument, or disconnection of the protective earth terminal can result in personal injury.
 - Before this instrument is switched on, make sure its primary power circuitry has been adapted to the voltage of the ac power source.

Failure to set the ac power input to the correct voltage could cause damage to the instrument when the ac power cable is plugged in.
-

Installation at a Glance

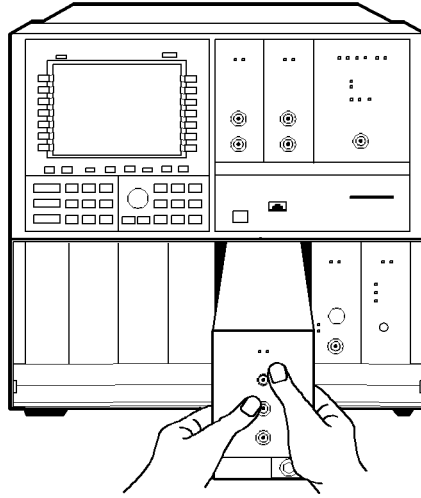

ACCESSORIES AND DOCUMENTATION SUPPLIED:

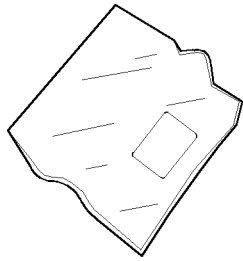

PACKAGE OF ACCESSORIES

TOOLS NEEDED:

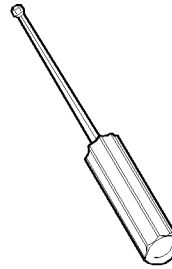

8 mm HEX-BALL DRIVER



NONCONDUCTIVE STYLUS (TOOTHPICK)

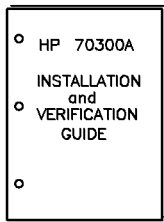

SUPPLEMENTAL DOCUMENT BEING ADDED

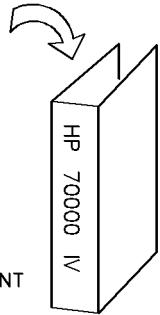

MAIN SYSTEM DOCUMENTATION

The HP 70300A RF tracking generator is a 2/8-width module designed to work in an HP 70000 Series modular measurement system. The HP 70300A RF tracking generator has a frequency range of 20 Hz to 2.9 GHz and is a slave module controlled by the HP 70900A/B local oscillator source. The output of the HP 70300A RF tracking generator tracks the tuned frequency of the spectrum analyzer (such as the HP 71210A microwave spectrum analyzer) with which it is used.

Early versions of the HP 70300A RF tracking generator had the output step attenuator available only as an option. Current versions of the module have the step attenuator as part of the standard module.

Documentation supplied

This installation guide is a supplemental document that should be added to the *HP 70000 Modular Spectrum Analyzer Installation and Verification Manual*.

In This Book

This book describes all of the installation procedures to properly install your tracking generator in an HP 70000 Series modular measurement system.

Each module in the HP 70000 Series modular measurement system has its own installation guide. For further information related to the installation of additional and alternate modules that can be used in this system, refer to that module's installation guide or refer to the *HP 70000 Modular Spectrum Analyzer Installation and Verification Manual*.

This installation guide consists of the following chapters.

Chapter 1, "General Information," describes conventions used in this manual, safety considerations, what to do at initial inspection. Also covered are issues of firmware compatibility, accessories, front-panel and rear-panel features, and a service kit that is available for your module.

Chapter 2, "Installation," provides information for configuring and installing the module in an HP 70000 Series modular measurement system.

Chapter 3, "Specifications," lists module specifications and characteristics.

Chapter 4, "Verification," contains information about the tests needed to verify module specifications.

Chapter 5, "Troubleshooting," explains the most probable causes of the front panel status/error LEDs' lighting, and lists the error codes that can be generated by the HP 70300A RF tracking generator.

An index is also added at the end of this installation guide to aid the user in finding key items of interest.

Before you begin installation, you must become familiar with the module address map. For information on the module address map, refer to Figure 2-1.

Contents

1. General Information	
Manual Conventions	1-1
Safety Considerations	1-1
Initial Inspection	1-1
Firmware Compatibility	1-2
Accessories	1-2
Front-Panel and Rear-Panel Features	1-3
Front-Panel Status/Error LEDs	1-3
Front-Panel Inputs and Outputs	1-4
Module Latch	1-4
Rear-Panel Inputs and Outputs	1-4
If You Need to Contact Hewlett-Packard	1-7
Determining Your Tracking Generator's Serial Number	1-7
Returning Your Tracking Generator to Hewlett-Packard	1-9
2. Installation	
Addressing the Module	2-2
Determining the HP-MSIB Address	2-2
Setting the HP-MSIB Address Switches	2-3
Installing the Module in the Mainframe	2-4
Connecting the Module-Interconnect Cables	2-5
HP 71100A Modular Spectrum Analyzer with an HP 70300A RF Tracking Generator	2-7
HP 71210A Microwave Spectrum Analyzer with an HP 70300A RF Tracking Generator and an HP 70301A Microwave Tracking Generator	2-9
Checking Module Operation	2-12
Observing the Front-Panel LEDs	2-12
Checking for Error Messages	2-12
3. Specifications	
4. Verification	
Explanation of Test Descriptions	4-1
TG Absolute Amplitude Accuracy	4-2
TG Vernier Accuracy	4-3
TG Frequency Response	4-4
TG Feedthru	4-5
5. Troubleshooting	
Status/Error LEDs	5-1
Error Messages	5-3
Usage/Operating Errors	5-3
Hardware Warning Errors	5-4
Hardware Broken Errors	5-4

Index

Figures

1-1. HP 70300A RF Tracking Generator's Front-Panel and Rear-Panel Features . . .	1-6
1-2. Typical Serial Number Label	1-7
2-1. Address Map	2-2
2-2. HP 70300A RF Tracking Generator Address Switches	2-3
2-3. Module Installation in Mainframe	2-4
2-4. HP 71100A Modular Spectrum Analyzer with an HP 70300A RF Tracking Generator	2-8
2-5. HP 71210A Microwave Spectrum Analyzer with an HP 70300A RF Tracking Generator and an HP 70301A Microwave Tracking Generator (1 of 2)	2-10
2-6. HP 71210A Microwave Spectrum Analyzer with an HP 70300A RF Tracking Generator and an HP 70301A Microwave Tracking Generator (2 of 2)	2-11

Tables

1-1. Accessories Shipped When Module is Ordered Separately	1-2
1-2. Hewlett-Packard Sales and Service Offices	1-8
1-3. Packaging for a 2/8 Module	1-10
2-1. Decimal Equivalents of Row and Column Address Switches	2-3
2-2. Module-Interconnect Cables for an HP 70000 Series Modular Measurement System	2-6
2-3. Cables for an HP 71100A Modular Spectrum Analyzer with an HP 70300A RF Tracking Generator	2-7
2-4. Cables and Adapters for an HP 71210A Microwave Spectrum Analyzer with HP 70300A RF Tracking Generator and HP 70301A Microwave Tracking Generator	2-10
3-1. System Specifications and Characteristics with HP 70300A RF Tracking Generator	3-2
3-2. System Specifications and Characteristics with HP 70300A RF Tracking Generator	3-3
3-3. System Specifications and Characteristics with HP 70300A RF Tracking Generator	3-4
3-4. General Specifications and Characteristics	3-4
3-5. HP 70300A RF Tracking Generator Input and Output Characteristics	3-5

General Information

Manual Conventions

The following descriptions are used throughout this manual:

Keys physically on an instrument are represented in the following way:

Key (KEY)

Softkeys, keys defined by software or firmware, are represented in the following way:

Softkey `softkey`

Text that appears on the display screen is represented in the following way:

Screen text `screen text`

Safety Considerations

Before operating this tracking generator, familiarize yourself with any safety markings on the tracking generator and the safety instructions in this manual. This tracking generator has been manufactured and tested according to international safety standards. However, to ensure safe operation of the tracking generator and personal safety of the user and service personnel, the cautions and warnings in this manual must be followed. Refer to the summary of safety considerations at the front of this manual.

Initial Inspection

Inspect the shipping container for damage. If the shipping container or cushioning material is damaged, it should be kept until the contents of the shipment have been checked for completeness and the tracking generator has been checked mechanically and electrically. Refer to “Accessories” to find out what is shipped with the HP 70300A RF tracking generator.

If the shipping contents are not complete, or the tracking generator does not pass the procedures in Chapter 4, notify the nearest Hewlett-Packard office. If the shipping container is damaged, or the cushioning material shows signs of stress, notify the carrier as well as the Hewlett-Packard office. Keep the shipping materials for the carrier’s inspection. The Hewlett-Packard office will arrange for repair or replacement without waiting for claim settlement.

Firmware Compatibility

For the HP 70300A RF tracking generator to function properly, the HP 70900A/B local oscillator source must have a firmware version *later* than 850730. A firmware-upgrade kit is included when HP 70300A RF tracking generator Option 099 is ordered.

Accessories

The HP 70300A RF tracking generator may be ordered separately or as part of a preconfigured HP 70000 Modular Measurement System. When the HP 70300A RF tracking generator is ordered separately, accessories are supplied for the most common system configurations. Table 1-1 lists the accessories shipping with the tracking generator at publication of this manual. When the HP 70300A RF tracking generator is ordered with a preconfigured HP 70000 Modular Measurement System, only the accessories required to configure the tracking generator in that specific configuration are included.

Table 1-1. Accessories Shipped When Module is Ordered Separately

Description	Qty	HP Part Number
Cables:		
Flexible, SMB (f) to SMB (f), 190 mm	4	5061-9017
Flexible, SMB (f) to SMB (f), 365 mm	4	8120-5022
Semi-rigid LO I/O, SMA (m) to SMA (m), 2/8-span, Left to Right*	1	5021-5449
Flexible LO I/O, SMA (m) to SMA (m), 52 cm (20 in.)	1	HP 5061-9038 SMA 0.5 meter flexible cable
Adapters:		
SMB tee (f)(m)(m)	1	HP 1250-1391 50Ω SMB tee(f) (m) (m)
*When connecting the cables, bends in the semi-rigid cable make it necessary to consider the relative positions of the signal source and destination. "Left to Right" refers to the signal flow OUT to IN as viewed from the <i>front</i> panel.		

Front-Panel and Rear-Panel Features

Figure 1-1 shows the HP 70300A RF tracking generator's front-panel and rear-panel features.

Front-Panel Status/Error LEDs

All of the front panel status/error LEDs flash on, then off again, during the tracking generator's self-test. Listed below are the other reasons for each LED to light. For troubleshooting information, refer to Chapter 5.

-
- CAUTION**
- When the AC COUPLED LED is lit, tracking generator damage may occur if the dc voltage level at the RF OUTPUT exceeds 25 V.
 - When the DC COUPLED LED is lit, tracking generator damage may occur if the dc voltage level at the RF OUTPUT exceeds 0 V.
 - The UNLEVELED LED will light when the reverse power at the RF OUTPUT is too high. Module damage may occur if the reverse power at the RF OUTPUT exceeds 1 W. Refer to UNLEVELED LED information below for the other conditions that will cause this LED to light.
-

- ACT** The ACT (active) LED lights when the tracking generator is activated by an HP 70000 Modular Measurement System master (for example, HP 70900A/B local oscillator source).
- ERR** The ERR (error) LED lights when an error condition exists.
- AC COUPLED** The AC COUPLED LED lights when the HP 70300A RF tracking generator input attenuator is ac-coupled with a blocking capacitor in-line. Switching to ac-coupled is accomplished by selecting the *normal* detector mode. When **PRESET** is pressed, the RF output is always set to ac-coupled.
- DC COUPLED** The DC COUPLED LED lights when the HP 70300A RF tracking generator input attenuator is dc-coupled (no blocking capacitor). Switching to dc-coupled is accomplished by selecting the *alternate* detector mode. The blocking capacitor can only be added or removed from the circuit by changing detectors.
- RF** The RF LED lights when the HP 70300A RF tracking generator RF OUTPUT power is on. The RF LED will be lit when **SRC PWR** is set to **ON**.
- UNLEVELED** The UNLEVELED LED lights when the RF OUTPUT power is unleveled. The following conditions can cause the RF OUTPUT power to be unleveled:
- The source power or power sweep levels are set too high.
 - The normal ALC detector is used at a frequency below the normal detector range.
 - A malfunction in the RF signal path results in the output power being too low.
 - The output is connected to a non-50Ω system.

Front-Panel Inputs and Outputs

Refer to Chapter 3, “Specifications,” for more information about the input and output characteristics.

AM INPUT/OUTPUT	This BNC (f) connector is the input and output for amplitude-modulating (AM) signals. <ul style="list-style-type: none">■ When used as an input, the port’s input impedance is 600Ω. An external source must be used to provide the AM input signal.■ When used as an output, the port’s output impedance is 20Ω. At 400 Hz or 1 kHz, the AM output signal amplitude is nominally 1 V peak.
EXT ALC INPUT	This BNC (f) connector is the input for external leveling. A negative diode detector, such as the HP 423B, should be used. The input voltage range is 0 to –100 mV.
RF OUTPUT	This type N (f) connector is the tracking generator’s RF output. Coupled mode: AC: 10 MHz to 2.9 GHz (normal detector) DC: 20 Hz to 10 MHz (alternate detector)

CAUTION	Module damage may result when <i>any</i> of the following conditions exist at the RF OUTPUT connector: <ul style="list-style-type: none">■ The reverse power exceeds 1 W.■ The voltage level exceeds 0 V dc when the tracking generator is dc-coupled (alternate detector mode).■ The voltage level exceeds 25 V dc when the tracking generator is ac-coupled (normal detector mode).
----------------	---

Module Latch

When the tracking generator is being installed in or removed from an HP 70000 Series modular measurement system mainframe, an 8 mm hex-ball driver is used to turn the tracking generator latch.

Rear-Panel Inputs and Outputs

Refer to Chapter 3, “Specifications,” for more information about the input and output characteristics.

LO IN 3.0—6.6 GHz	This SMA (f) connector is the input for the 1st LO OUT signal from the RF section.
LO OUT 3.0—6.6 GHz	This SMA (f) connector is only present on earlier versions of the HP 70300A RF tracking generator. When present, this connector is normally terminated in 50 Ω .
3.6214 GHz OUT	This SMA (f) connector is only present on earlier versions of the HP 70300A RF tracking generator. The 3.6214 GHz signal is the tracking generator’s 2nd-IF signal. When present, this connector normally connects to the 3.6214 GHz IN connector.
3.6214 GHz IN	This SMA (f) connector is only present on earlier versions of the HP 70300A RF tracking generator. When present, this connector normally connects to the 3.6214 GHz OUT connector.

0—2.9 GHz OUT	This SMA (f) connector normally connects to the 0—2.9 GHz IN connector. The 0-2.9 GHz OUT port is after the first converter, but before the output attenuator and the normal ALC detector.
0—2.9 GHz IN	This SMA (f) connector normally connects to the 0—2.9 GHz OUT connector.
300 MHz OUT	The signal available at this SMB (m) connector is the 300 MHz IN signal. This connector can be connected to a 300 MHz input on another tracking generator.
300 MHz IN	This SMB (m) connector is connected to the 300 MHz OUT connector on the HP 70900A/B local oscillator source.
21.4 MHz IN	This SMB (m) connector can be used as either an input or an output for the tracking generator 21.4 MHz reference IF signal. When this connector is used as an input, the 21.4 MHz reference IF signal must be provided by an external signal generator. When this connector is used as an output, the 21.4 MHz reference IF signal is derived from the tracking generator 21.4 MHz internal oscillator.
SWEEP IN	This SMB (m) connector normally connects to SWEEP on the HP 70900A/B local oscillator source. The SWEEP IN signal is used to drive the power sweep of the tracking generator.
TUNE + SPAN IN	This SMB (m) connector normally connects to TUNE SPAN on the HP 70900A/B local oscillator source. The TUNE+SPAN IN signal drives the dynamic leveling of the tracking generator's output signal.
HSWP IN	This SMB (m) connector normally connects to HSWP on the HP 70900A/B local oscillator source
Mainframe/Module Interconnect	This multiple-pin connector plugs into the mainframe and provides the power supplies and Hewlett-Packard Modular System Interface Bus (HP-MSIB) for the tracking generator.

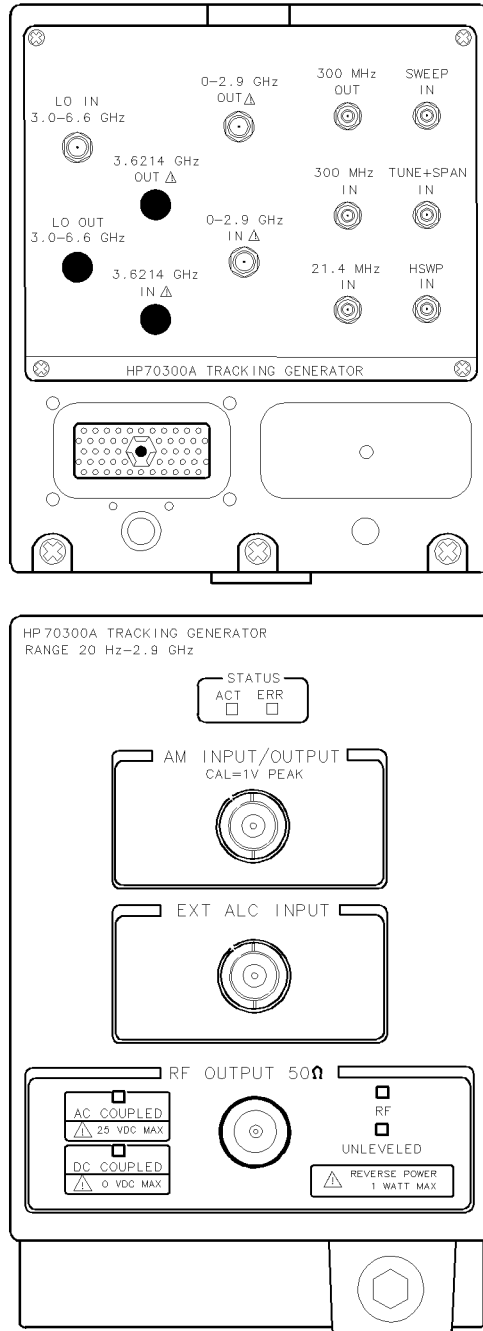

Figure 1-1. HP 70300A RF Tracking Generator's Front-Panel and Rear-Panel Features

If You Need to Contact Hewlett-Packard

Before calling Hewlett-Packard or returning your tracking generator, please read your warranty information. Warranty information is printed at the front of this document.

In any correspondence or telephone conversations, refer to the tracking generator by its full model number and full serial number. With this information, the Hewlett-Packard representative can determine whether your unit is still within its warranty period.

Determining Your Tracking Generator's Serial Number

When a module is manufactured by Hewlett-Packard, it is given a unique serial number. This serial number is attached to a label on the front frame or front panel of the module. A serial number label is in two parts. (Refer to Figure 1-2.) The first part makes up the serial number prefix and consists of four digits and a letter. The second part makes up the serial number suffix and consists of the last five digits on the serial number label. The serial number prefix is the same for all identical modules; it only changes when a change in the electrical or physical functionality is made. The serial number suffix, however, changes sequentially and is different for each module.



Figure 1-2. Typical Serial Number Label

Table 1-2. Hewlett-Packard Sales and Service Offices

US FIELD OPERATIONS HEADQUARTERS	EUROPEAN OPERATIONS HEADQUARTERS	INTERCON OPERATIONS HEADQUARTERS
Hewlett-Packard Company 19320 Pruneridge Avenue Cupertino, CA 95014, USA (800) 752-0900	Hewlett-Packard S.A. 150, Route du Nant-d'Avril 1217 Meyrin 2/Geneva Switzerland (41 22) 780.8111	Hewlett-Packard Company 3495 Deer Creek Rd. Palo Alto, California 94304-1316 (415) 857-5027
California Hewlett-Packard Co. 1421 South Manhattan Ave. Fullerton, CA 92631 (714) 999-6700 Hewlett-Packard Co. 301 E. Evelyn Mountain View, CA 94041 (415) 694-2000	France Hewlett-Packard France 1 Avenue Du Canada Zone D'Activite De Courtaboeuf F-91947 Les Ulis Cedex France (33 1) 69 82 60 60	Australia Hewlett-Packard Australia Ltd. 31-41 Joseph Street (P.O. Box 221) Blackburn, Victoria 3130 (61 3) 895-2895
Colorado Hewlett-Packard Co. 24 Inverness Place, East Englewood, CO 80112 (303) 649-5000	Germany Hewlett-Packard GmbH Hewlett-Packard-Strasse 61352 Bad Homburg Germany (+ 49 6172) 16-0	Canada Hewlett-Packard (Canada) Ltd. 17500 South Service Road Trans-Canada Highway Kirkland, Quebec H9J 2X8 Canada (514) 697-4232
Georgia Hewlett-Packard Co. 2000 South Park Place Atlanta, GA 30339 (404) 955-1500	Great Britain Hewlett-Packard Ltd. Eskdale Road, Winnersh Triangle Wokingham, Berkshire RG11 5DZ England (44 734) 696622	Japan Yokogawa-Hewlett-Packard Ltd. 1-27-15 Yabe, Sagamihara Kanagawa 229, Japan (81 427) 59-1311
Illinois Hewlett-Packard Co. 5201 Tollview Drive Rolling Meadows, IL 60008 (708) 342-2000		China China Hewlett-Packard, Co. 38 Bei San Huan X1 Road Shuang Yu Shu Hai Dian District Beijing, China (86 1) 256-6888
New Jersey Hewlett-Packard Co. 150 Green Pond Road Rockaway, NJ 07866 (201) 586-5400		Singapore Hewlett-Packard Singapore Pte. Ltd. Alexandra P.O. Box 87 Singapore 9115 (65) 271-9444
Texas Hewlett-Packard Co. 930 E. Campbell Rd. Richardson, TX 75081 (214) 231-6101		Taiwan Hewlett-Packard Taiwan 8th Floor, H-P Building 337 Fu Hsing North Road Taipei, Taiwan (886 2) 712-0404

Returning Your Tracking Generator to Hewlett-Packard

Hewlett-Packard has sales and service offices around the world to provide complete support for your tracking generator. To obtain servicing information or to order replacement parts, contact the nearest Hewlett-Packard sales and service office listed in Table 1-2.

Use the following procedure to return your tracking generator to Hewlett-Packard:

1. Fill out a service tag (available at the end of this service guide) and attach it to the instrument. Please be as specific as possible about the nature of the problem. Send a copy of any or all of the following information:
 - any error messages that appeared on the HP 70000 Series display
 - a completed Performance Test record
 - any other specific data on the performance of the tracking generator

CAUTION Damage can result if the original packaging materials are not used. Packaging materials should be anti-static and should cushion the tracking generator on all sides.

Never use styrene pellets in any shape as packaging materials. They do not adequately cushion the instrument or prevent it from moving in the shipping container. Styrene pellets can also cause equipment damage by generating static electricity or by lodging in fan motors.

2. Place the tracking generator in its original packaging materials.

If the original packaging materials are not available, you can contact a Hewlett-Packard sales and service office to obtain information on packaging materials or you may use an alternative packing material referred to as “bubble-pack”. One of the companies that makes bubble-pack is Sealed Air Corporation of Hayward, California, 94545.

3. Surround the tracking generator with at least 3 to 4 inches of its original packing material or bubble-pack to prevent the tracking generator from moving in its shipping container.
4. Place the tracking generator, after wrapping it with packing material, in its original shipping container or a strong shipping container that is made of double-walled corrugated cardboard with 159 kg (350 lb) bursting strength.

The shipping container must be both large enough and strong enough to accommodate your tracking generator and allow at least 3 to 4 inches on all sides for packing material.

5. Seal the shipping container securely with strong nylon adhesive tape.
6. Mark the shipping container “FRAGILE, HANDLE WITH CARE” to help ensure careful handling.
7. Retain copies of all shipping papers.

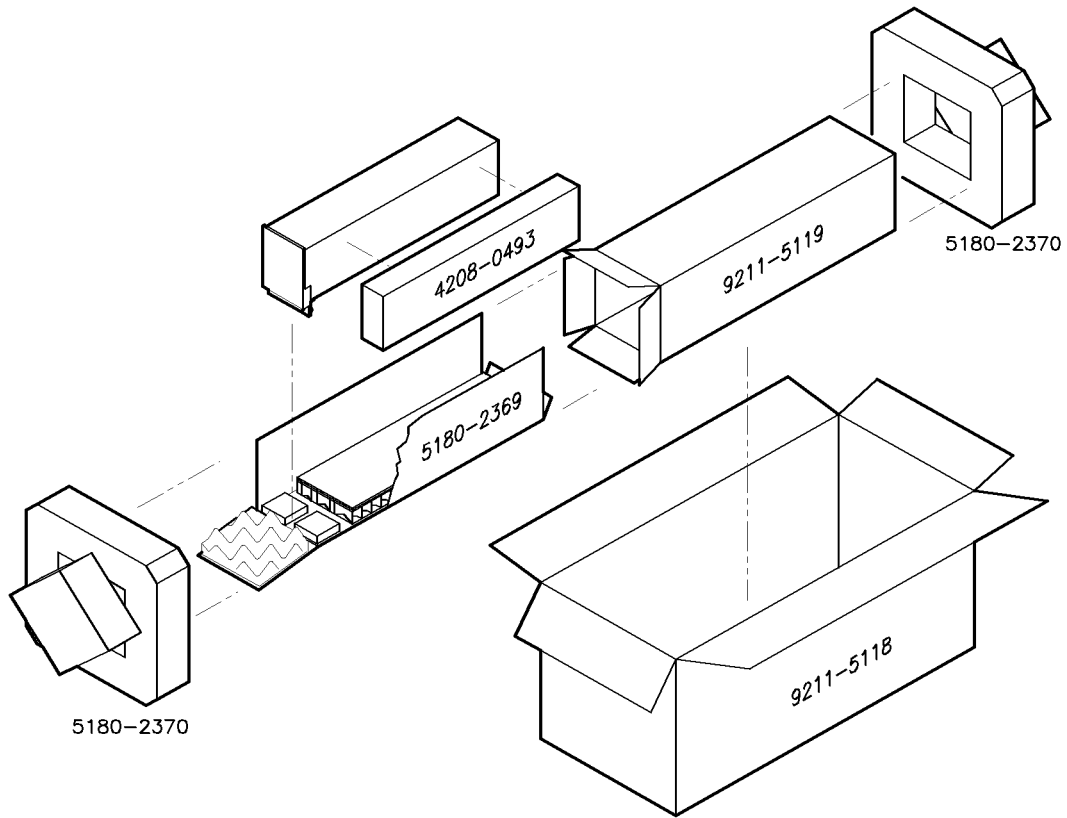

packing2

Table 1-3. Packaging for a 2/8 Module

Item	Description	HP Part Number	Qty
1	Carton-outer	5180-8479	1
2	Carton-inner	9211-4781	1
3	Carton-sliders	5180-2369	1
4	Foam inserts	4208-0493	1
5	Foam pads	5180-8469	2

Installation

This chapter contains information needed to install the HP 70300A RF tracking generator into an HP 70000 Series modular measurement system mainframe, and to check the basic operation of the tracking generator. Chapter 4 contains the tests needed to verify that the tracking generator meets its specifications. For more detailed information about HP 70000 Series modular measurement system configuration and addressing, refer to the *HP 70000 Modular Spectrum Analyzer Installation and Verification Manual*.

Examples of addressing and cable connections are given for the following configurations:

- HP 71100A modular spectrum analyzer with an HP 70300A RF tracking generator.
- HP 71210A microwave spectrum analyzer with both an HP 70300A RF tracking generator and an HP 70301A microwave tracking generator.

Installing the tracking generator in an HP 70000 Series modular measurement system requires the following steps:

1. Addressing the tracking generator.
2. Installing the tracking generator into the mainframe.
3. Connecting the tracking generator-interconnect cables.

When properly installed, the HP 70300A RF tracking generator obtains both power and interface-bus control through the tracking generator's rear panel mainframe/tracking generator interconnect. After the tracking generator is installed, use the information in "Checking Module Operation" to make sure that the tracking generator has been properly installed and is not faulty.

Addressing the Module

The HP 70300A RF tracking generator needs an appropriate Hewlett-Packard Modular System Interface Bus (HP-MSIB) address to be able to communicate with the master of the HP 70000 Series modular measurement system. The HP 70300A RF tracking generator's HP-MSIB address is set using the tracking generator's ROW and COLUMN address switches.

Determining the HP-MSIB Address

The HP 70300A RF tracking generator has a factory-preset HP-MSIB address of 6, 19 (row 6, column 19). Figure 2-1 shows the address map for an HP 70300A RF tracking generator configured with an HP 71100A modular spectrum analyzer. The addresses in this figure are the factory-preset addresses for the tracking generators.

			70310A FREQ REF		
		70904A RF SECT	70300A TRK GEN		
R O W	4	70903A IF SECT			
	3				
	2	70902A IF SECT			
	1				
	0	70900A/B LO/CTLR HP-1B18			
		17	18	19	20
		COLUMN			

dda211

Figure 2-1. Address Map

If the HP 70300A RF tracking generator is going to be used in an HP 70000 Modular Spectrum Analyzer System where the tracking generators all have their factory-preset addresses, the HP 70300A RF tracking generator probably will not need to have its factory-preset address changed. However, if the factory-preset addresses of the tracking generators in the system have been changed, or if the HP 70300A RF tracking generator is being used in another type of HP 70000 Series modular measurement system, the HP 70300A RF tracking generator's factory-preset address may need to be changed.

Changing HP-MSIB addresses requires an understanding of HP-MSIB addressing rules. For information on determining and assigning HP-MSIB addresses, refer to the *HP 70000 Modular Spectrum Analyzer Installation and Verification Manual*.

Setting the HP-MSIB Address Switches

The HP 70300A RF tracking generator's address switches are located on the top of the tracking generator. Table 2-1 gives the decimal value for each address switch when the switch is set to binary 1 (ON).

Table 2-1. Decimal Equivalents of Row and Column Address Switches

Address Switch	Decimal Value
Row	
3*	4
2*	2
1	1
Column	
5*	16
4	8
3	4
2*	2
1*	1
*These switches are factory-preset to binary 1 (ON), resulting in an HP-MSIB address of 6, 19 (row 6, column 19).	

Use the procedure below to change the address switches:

1. Set the three ROW switches to the binary value of the tracking generator's HP-MSIB row number. For example, if the row number is 6, change the switches to binary 110 as shown in Figure 2-2.
2. Set the five COLUMN switches to the binary value of the tracking generator's HP-MSIB column number. For example, if the column number is 19, change the switches to binary 10011 as shown in Figure 2-2.

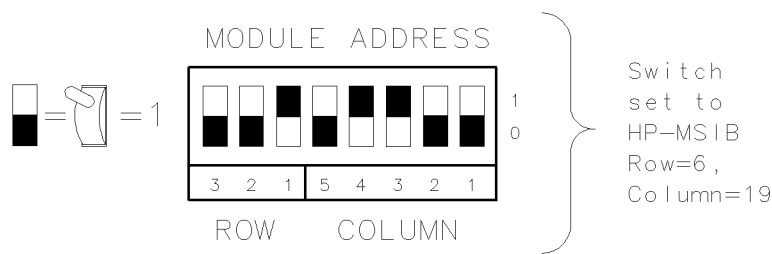
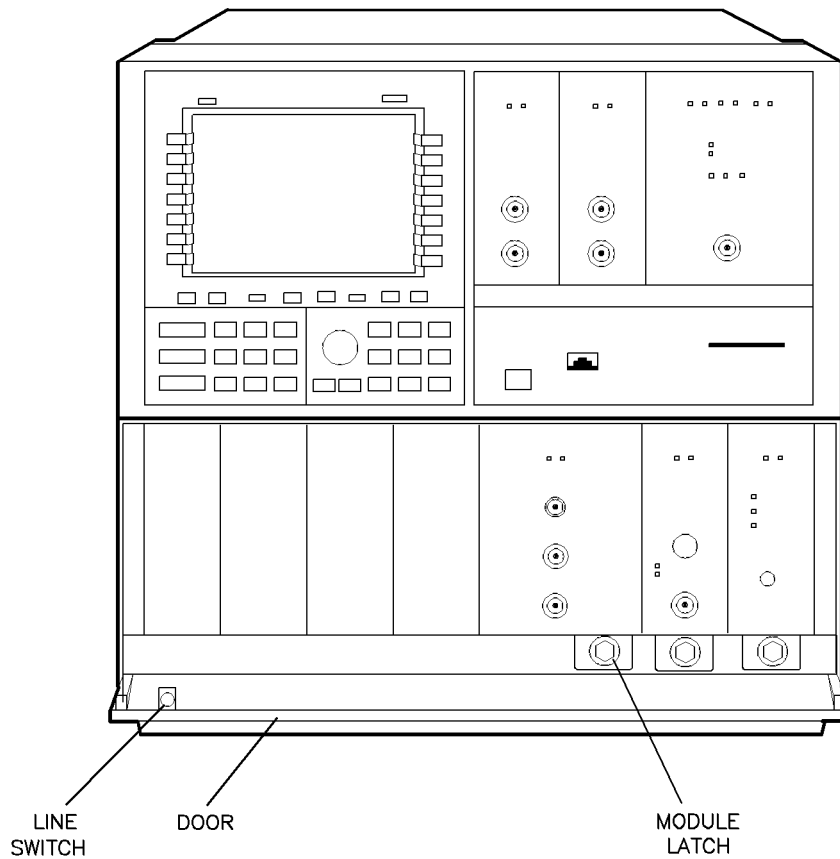

Figure 2-2. HP 70300A RF Tracking Generator Address Switches

Installing the Module in the Mainframe

The HP 70300A RF tracking generator needs to be installed in an HP 70000 Series modular measurement system mainframe before it will operate. Follow the procedure below to install the tracking generator into the mainframe. See Figure 2-3 for identification of the tracking generator and mainframe parts called out in the procedure.

1. Turn the mainframe LINE switch off.
2. Open the mainframe front panel door.
3. Slide the tracking generator into the mainframe.
4. Press against the tracking generator front panel while tightening the tracking generator latch with an 8 mm hex-ball driver.
5. Close the mainframe front panel door.



dda231

Figure 2-3. Module Installation in Mainframe

Connecting the Module-Interconnect Cables

This section contains addressing and tracking generator-interconnect cabling information for the following system configurations:

- HP 71100A modular spectrum analyzer with an HP 70300A RF tracking generator.
- HP 71210A microwave spectrum analyzer with both an HP 70300A RF tracking generator and an HP 70301A microwave tracking generator.

In addition to the module-interconnect cables listed, system HP-MSIB cables must be connected. Refer to the *HP 70000 Modular Spectrum Analyzer Installation and Verification Manual*.

Table 2-2 lists the module-interconnect cables available at the time this manual was published. The column labeled “L/R” refers to the signal flow OUT to IN as viewed from the *front* panel. When connecting the cables, bends in the semi-rigid cable make it necessary to consider the relative positions of the signal source and destination. For example, order a “L to R” cable if a given configuration, as viewed from the front, places a signal source to the left of the signal destination.

**Table 2-2.
Module-Interconnect Cables for an HP 70000 Series Modular
Measurement System**

Description	HP Part Number	Span	L/R
Semi-rigid Type N: Type N (m) to SMA (m)	5021-9319	n/a	n/a
Semi-rigid LO I/O Cables: SMA(m) to SMA(m)	5021-5448	1/8	L to R
SMA(m) to SMA(m)	5021-5449*	2/8	L to R
SMA(m) to SMA(m)	5021-5450	3/8	L to R
SMA(m) to SMA(m)	5021-5451	4/8	L to R
SMA(m) to SMA(m)	5021-5452	5/8	L to R
SMA(m) to SMA(m)	5021-5453	6/8	L to R
SMA(m) to SMA(m)	5021-5454	7/8	L to R
SMA(m) to SMA(m)	5021-5491	1/8	R to L
SMA(m) to SMA(m)	5021-5492	2/8	R to L
SMA(m) to SMA(m)	5021-5493	3/8	R to L
SMA(m) to SMA(m)	5021-5494	4/8	R to L
SMA(m) to SMA(m)	5021-5495	5/8	R to L
SMA(m) to SMA(m)	5021-5496	6/8	R to L
SMA(m) to SMA(m)	5021-5497	7/8	R to L
Flexible LO I/O Cables: SMA(m) to SMA(m), 52 cm (20 in.)	5061-9038*	n/a	n/a
SMA(m) to SMA(m), 74.5 cm (29 in.)	5061-9039	n/a	n/a
Flexible System Cables: SMB(f) to SMB(f), 100 mm	5061-9015	1/8	n/a
SMB(f) to SMB(f), 160 mm	5061-9016	2/8	n/a
SMB(f) to SMB(f), 190 mm	5061-9017*	3/8	n/a
SMB(f) to SMB(f), 240 mm	5061-9018	4/8	n/a
SMB(f) to SMB(f), 290 mm	5061-9019	5/8	n/a
SMB(f) to SMB(f), 365 mm	5061-9020*	6/8	n/a
SMB(f) to SMB(f), 390 mm	5061-9021	7/8	n/a
*These cables are shipped with the tracking generator when the tracking generator is ordered separately. Refer to "Accessories" in Chapter 1 for more information.			

Note Older HP 70300A RF tracking generators may have three additional connectors: 3.6214 GHz IN, 3.6214 GHz OUT, and LO OUT 3.0–6.6 GHz. When these connectors are present, use a jumper cable to connect 3.6214 GHz IN and 3.6214 GHz OUT together, and connect a 50Ω termination to LO OUT 3.0–6.6 GHz.

HP 71100A Modular Spectrum Analyzer with an HP 70300A RF Tracking Generator

To configure an HP 70300A RF tracking generator into an HP 71100A modular spectrum analyzer, connect the tracking generator-interconnect cables according to the following list. The number in parentheses is the HP part number of the cable used for the connection. Table 2-3 gives the total quantity of each cable required for the illustrated configuration. Figure 2-4 illustrates the address map and cable connections.

CAUTION Do not exceed 8 inch-pounds of torque when tightening APC 3.5 and SMA connectors. To ensure proper electrical connection and help prevent connector damage, torque all APC 3.5 and SMA connectors from 5 to 8 inch-pounds.

HP 70300A RF Tracking Generator Connections

- Tracking generator LO IN to RF section LO OUT. (5021-5449)
- Tracking generator 300 MHz IN to LO tracking generator 300 MHz OUT 2. (5061-9017)
- Tracking generator SWEEP IN to LO tracking generator SWEEP. (5061-9017)
- Tracking generator TUNE+SPAN IN to LO tracking generator TUNE SPAN. (5061-9017)
- Tracking generator HSWP IN to LO tracking generator HSWP IN/OUT. (5061-9017)
- Tracking generator 0–2.9 GHz OUT to tracking generator 0–2.9 GHz IN.

Other Connections

- LO tracking generator 300 MHz OUT 1 to RF section 300 MHz IN. (5061-9015)
- LO tracking generator VIDEO IN to IF section VIDEO OUT. (5061-9016)
- LO tracking generator LO OUT to RF section 1st LO IN. (5021-5449)
- RF section 21.4 MHz OUT to IF section 21.4 MHz IN. (5061-9016)

Table 2-3.
Cables for an HP 71100A Modular Spectrum Analyzer with an HP 70300A RF Tracking Generator

Description	HP Part Number	Quantity Required
Semi-rigid, LO I/O	5021-5449	2
Flexible, System	5061-9015	1
	5061-9016	2
	5061-9017	4

SYSTEM COMPONENTS:

- HP 70001A MAINFRAME
- HP 70205A GRAPHICS DISPLAY
or HP 70004A COLOR DISPLAY
- HP 70900A LOCAL OSCILLATOR
- HP 70902A IF SECTION
- HP 70904A RF SECTION
- HP 70300A TRACKING GENERATOR

THE HP 70001A MAINFRAME DOES NOT HAVE AN HP-MSIB ADDRESS. THE USUAL ADDRESS FOR THE HP 70205A OR HP 70206A DISPLAYS IS ROW 0, COLUMN 4.

ADDRESSING EXAMPLE

7				
6		70904A RF SECT	70300A TRK GEN	
5				
R O W 4				
3				
2		70902A IF SECT		
1				
0		70900A/B LO/CTLR HP-1B1B		
	17	18	19	20
	COLUMN			

CABLE CONNECTION EXAMPLE

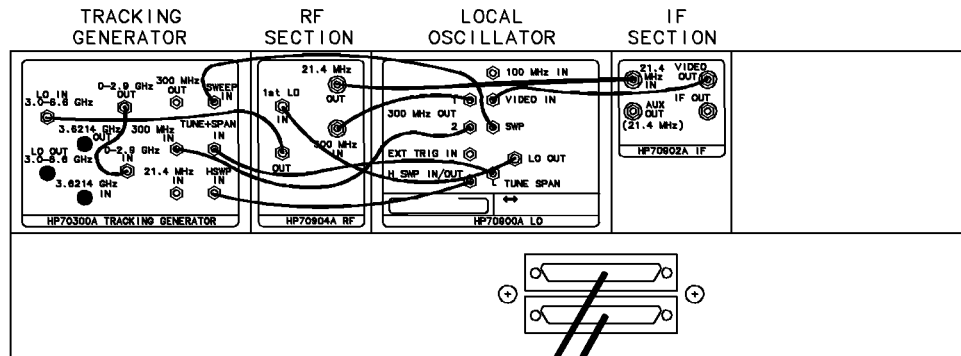

Connect HP-MSIB cables to HP 70206A, or a mainframe containing the HP 70205A or an HP 70004A color display.

dda24f

Figure 2-4.
HP 71100A Modular Spectrum Analyzer with an HP 70300A RF Tracking Generator

HP 71210A Microwave Spectrum Analyzer with an HP 70300A RF Tracking Generator and an HP 70301A Microwave Tracking Generator

To configure an HP 70300A RF tracking generator and an HP 70301A microwave tracking generator into an HP 71210A microwave spectrum analyzer, connect the tracking generator-interconnect cables according to the following list. The number in parentheses is the HP part number of the cable used for the connection. Table 2-4 gives the total quantity of each cable and adapter required for the illustrated configuration. Figure 2-5 illustrates the address map and cable connections.

CAUTION Do not exceed 8 inch-pounds of torque when tightening APC 3.5 and SMA connectors. To ensure proper electrical connection and help prevent connector damage, torque all APC 3.5 and SMA connectors from 5 to 8 inch-pounds.

HP 70300A RF Tracking Generator Connections

- HP 70300A RF tracking generator front panel RF OUTPUT to HP 70301A microwave tracking generator front panel LOW BAND INPUT. (5021-9319)
- HP 70300A RF tracking generator LO IN to HP 70301A microwave tracking generator LO OUT. (5021-5449)
- HP 70300A RF tracking generator 300 MHz OUT to HP 70301A microwave tracking generator 300 MHz IN. (5061-9016)
- HP 70300A RF tracking generator 300 MHz IN to LO tracking generator 300 MHz OUT 2. (5061-9020)
- HP 70300A RF tracking generator SWEEP IN to LO tracking generator SWEEP. (5061-9019)
- LO tracking generator TUNE SPAN to RF section TUNE SPAN, HP 70300A RF tracking generator TUNE SPAN, and HP 70301A microwave tracking generator TUNE SPAN. (5061-9018, 5061-9017, 5061-9016)
- HP 70300A RF tracking generator HSWP IN to LO tracking generator HSWP IN/OUT. (5061-9020)

Other Connections

- LO tracking generator 300 MHz OUT 1 to RF section 300 MHz IN. (5061-9019)
- LO tracking generator 100 MHz IN to HP 70310A precision frequency reference 100 MHz. (5061-9019)
- LO tracking generator VIDEO IN to HP 70903A IF section VIDEO OUT. (5061-9016)
- LO tracking generator LO OUT to RF section 1st LO IN. (HP 5061-9038 SMA 0.5 meter flexible cable)
- RF section LO OUT to HP 70301A microwave tracking generator LO IN. (5021-5495)
- RF section 21.4 MHz OUT to HP 70903A IF section 21.4 MHz IN. (5061-9019)
- HP 70902A IF section VIDEO OUT to HP 70903A IF section VIDEO IN. (5061-9015)
- HP 70902A IF section 21.4 MHz IN to HP 70903A IF section 21.4 MHz OUT. (5061-9015)
- External power pack to HP 70310A precision frequency reference EXT PWR.
- HP 70301A microwave tracking generator 21.4 MHz IN to HP 70301A microwave tracking generator 21.4 MHz OUT.

Table 2-4.
Cables and Adapters
for an HP 71210A Microwave Spectrum Analyzer with
HP 70300A RF Tracking Generator and HP 70301A Microwave Tracking
Generator

Description	HP Part Number	Quantity Required
Semi-rigid, Type N	5021-9319	1
Semi-rigid, LO I/O	5021-5449	1
	5021-5495	1
Flexible, LO I/O	HP 5061-9038 SMA 0.5 meter flexible cable	1
Flexible, System	5061-9015	2
	5061-9016	3
	5061-9017	1
	5061-9018	1
	5061-9019	4
	5061-9020	2
Adapter, SMB tee (f)(m)(m)	HP 1250-1391 50Ω SMB tee(f) (m) (m)	2

SYSTEM COMPONENTS:

HP 70001A MAINFRAME
 HP 70206A SYSTEM GRAPHICS DISPLAY
 or HP 70004A COLOR DISPLAY
 HP 70300A TRACKING GENERATOR
 HP 70301A TRACKING GENERATOR
 HP 70310A PRECISION FREQUENCY REFERENCE
 HP 70900A LOCAL OSCILLATOR
 HP 70902A IF SECTION
 HP 70903A IF SECTION
 HP 70908A RF SECTION

THE HP 70001A MAINFRAME DOES NOT HAVE
 AN HP-MSIB ADDRESS. THE USUAL ADDRESS
 FOR THE HP 70205A OR HP 70206A DISPLAYS
 IS ROW 0, COLUMN 4.

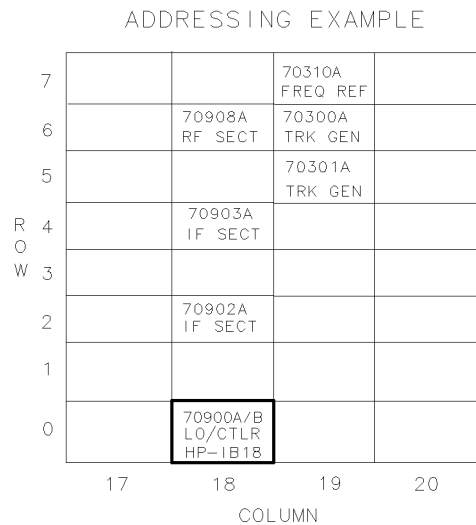
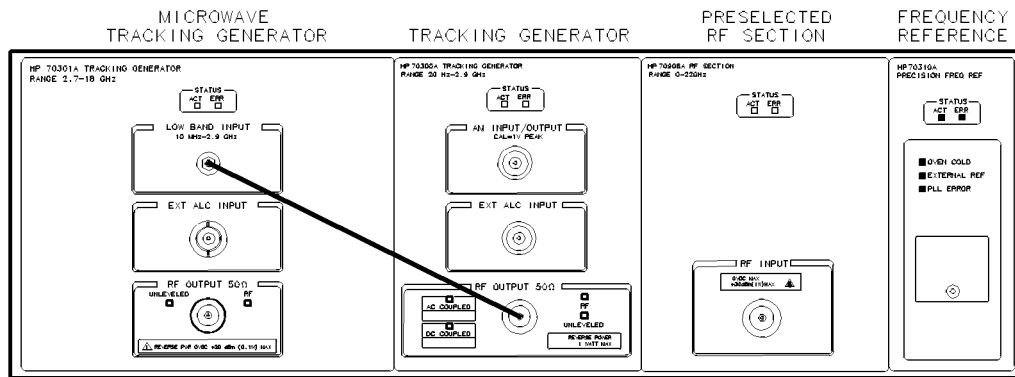
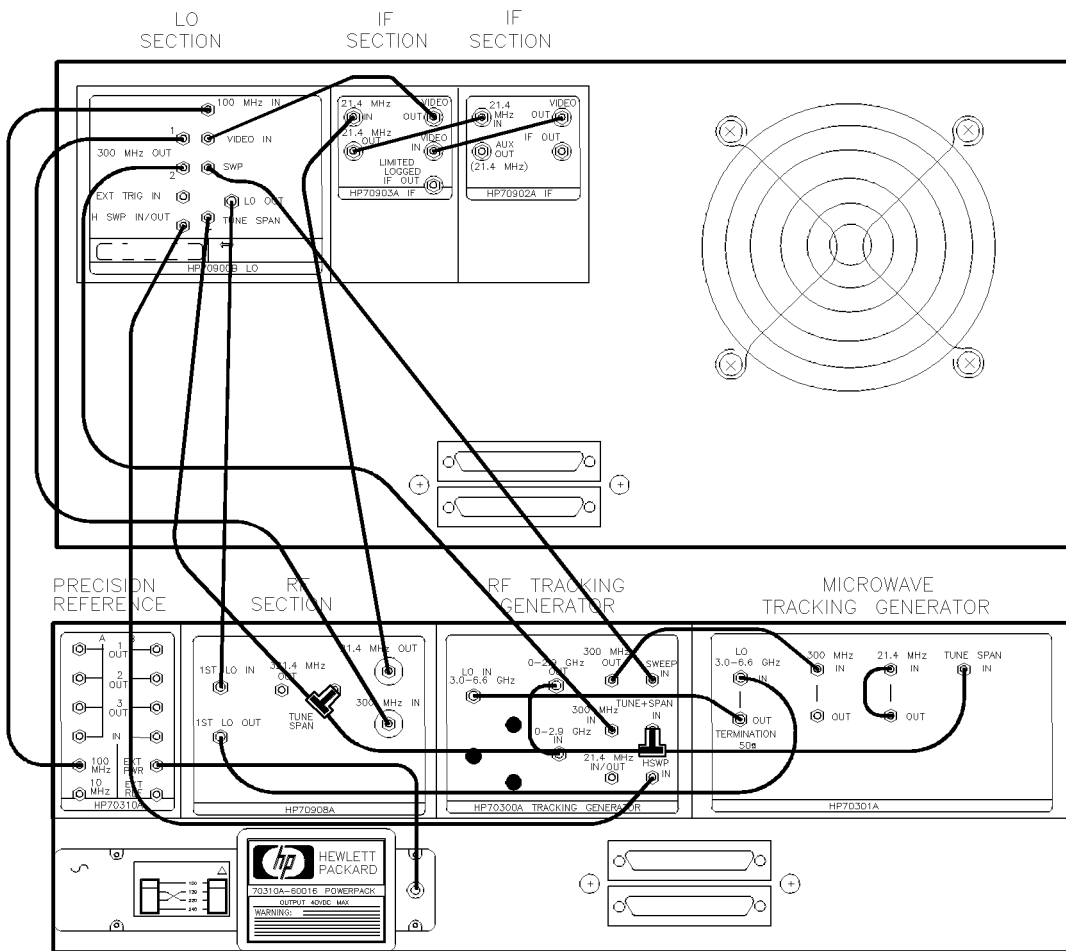

Figure 2-5.
HP 71210A Microwave Spectrum Analyzer with an HP 70300A RF Tracking Generator
and an HP 70301A Microwave Tracking Generator (1 of 2)

Front-panel tracking generator cable connections



Rear-panel system cable connections



dda25bl

Figure 2-6.
HP 71210A Microwave Spectrum Analyzer with an HP 70300A RF Tracking Generator and an HP 70301A Microwave Tracking Generator (2 of 2)

Checking Module Operation

The operation of the HP 70300A RF tracking generator in an HP 70000 Series modular measurement system is verified by checking the results of the tracking generator's power-on self-test. Refer to Chapter 4 for tests that verify the tracking generator specifications.

The results of the self-test are determined by observing the front panel LEDs and by checking for error messages.

CAUTION When the AC COUPLED LED is lit, tracking generator damage may occur if the voltage level at the RF OUTPUT exceeds 25 V dc.

When the DC COUPLED LED is lit, tracking generator damage may occur if the voltage level at the RF OUTPUT exceeds 0 V dc.

The UNLEVELED LED will light when the reverse power at the RF OUTPUT is too high. Module damage may occur if the reverse power at the RF OUTPUT exceeds 1 W. Refer to UNLEVELED LED information for the other conditions that will cause the UNLEVELED LED to light.

Observing the Front-Panel LEDs

The power-on self-test runs automatically when power is first applied to the tracking generator. During the self-test, the LEDs will flash on, then off again. The following listing describes what the status of the LEDs should be immediately after the self-test has run.

- The ACT LED should be on.
- The ERR LED should be off.
- The AC COUPLED LED should be off.
- The DC COUPLED LED should be off.
- The RF LED should be off.
- The UNLEVELED LED should be off.

If the tracking generator's RF OUTPUT power is turned on, the ACT LED, the RF LED, and either the AC COUPLED LED or the DC COUPLED LED should be on. Refer to Chapter 5, "Troubleshooting," if the LEDs' status is different than that listed above.

Checking for Error Messages

The procedure below is for use when the HP 70300A RF tracking generator is part of an HP 70000 Series modular measurement system that contains a display and has an HP 70900A/B local oscillator source as the system master. Perform this procedure to display any error messages present for the system.

1. Press the **MENU** key.
2. The error messages for the system will be visible on the display screen. Note any error messages that have 70300A as part of the error code. The last two numbers (6, 19) are the tracking generator's HP-MSIB address, and will be different if the factory-preset address has been changed.
3. If any error messages are present for the HP 70300A RF tracking generator, refer to Chapter 5 for troubleshooting information.

Specifications

This chapter contains characteristics and measurement-related specifications. Table 3-1 lists the system specifications and characteristics that are modified when the HP 70300A RF tracking generator is used in an HP 70000 Series modular measurement system spectrum analyzer configuration. For any system specifications or characteristics not listed here, refer to the *HP 70000 Modular Spectrum Analyzer Installation and Verification Manual*.

Table 3-1 and Table 3-4 contain both specifications and characteristics. Characteristics are in *italics* and are identified with the word *characteristic*. The terms “specifications” and “characteristics” are defined below:

Specifications	describe warranted performance over the temperature range of 0°C to +55°C (unless otherwise noted) after one hour of continuous operation. Specifications apply after system temperatures have stabilized and self-calibration routines have run. Unless otherwise noted, corrected limits are given when a specification range is improved with error-correction routines. All specifications that are qualified by an output-power setting refer to that setting.
Typical performance	where listed, is <i>not warranted</i> , but indicates performance which most units will meet.
Characteristics	provide useful, but <i>non-warranted</i> , functional and performance information.
Nominal values	indicate the expected, but <i>non-warranted</i> , value of the denoted parameter.

**Table 3-1.
System Specifications and Characteristics with HP 70300A
RF Tracking Generator**

Parameters	Specifications and Characteristics
Frequency Range As a source: With spectrum analyzer:	20 Hz to 2.9 GHz (dc coupled) 100 kHz to 2.9 GHz (ac coupled) Resolution <1 Hz 100 Hz to 2.9 GHz
Frequency Accuracy Span \leq 10 MHz: Span >10 MHz:	\pm [(frequency readout \times frequency reference accuracy*) + 1% of span + 15 Hz [†]] \pm [(frequency readout \times frequency reference accuracy*) + 2% of span + 15 Hz [†]]
<i>Frequency Tracking Range (characteristic)</i>	\pm 500 Hz <i>Resolution <1 Hz</i>
<i>Frequency Tracking Drift (characteristic)</i>	<3Hz/hour after warm-up
Amplitude Range Total:	-10 dBm to -91 dBm, 0.01 dB resolution
Amplitude Accuracy Absolute Accuracy ^{‡, §} : Amplitude Flatness [‡] : Vernier Accuracy [§] : Total Absolute Accuracy ^{‡, §} :	\pm 0.75 dB at 300 MHz (normal detection) \pm 0.5 dB at 1 MHz (alternate detection) \pm 0.5 dB relative to 300 MHz (normal detection) +1.2 to -0.7 dB relative to 1 MHz (alternate detection) \pm 0.15 dB/dB, \pm 0.5 dB total \pm 1.75 dB at 300 MHz (normal detection) +2.2 dB to -1.7 dB at 1 MHz (alternate detection)
*Refer to Frequency Reference Accuracy for the particular system in the "Specifications" chapter of the <i>HP 70000 Modular Spectrum Analyzer Installation and Verification Manual</i> . [†] Uncorrected, error is 150 Hz with tracking adjusted to 0 Hz. [‡] Normal detection is used for output frequencies of 10 MHz to 2.9 GHz. Alternate detection is used for output frequencies of 20 Hz to 10 MHz. [§] Applicable for the temperature range of 25°C \pm 5°C.	

**Table 3-2.
System Specifications and Characteristics with HP 70300A
RF Tracking Generator**

Parameters	Specifications and Characteristics
<i>Amplitude Drift (characteristic)</i>	$< \pm 0.05 \text{ dB per } ^\circ\text{C at } -10 \text{ dBm}$
Amplitude Modulation	
Depth:	0 to 100%
Accuracy:	$\leq 80\%$: $\pm 4\%$ AM at -13 dBm (normal detection) $\pm 6\%$ AM at -13 dBm (alternate detection)
Rates:	Internal: 400 Hz and 1 kHz ($\pm 3\%$) External: 20 Hz to 20 kHz (3 dB BW at 30% AM)
Resolution:	1%
Distortion:	$< 10\%$ for 80% AM (at internal rates; with normal detection) $< 4\%$ for 30% AM (with alternate detection) measured at -13 dBm output power
Incidental phase: Modulation:	CW mode, 50 Hz to 15 kHz post-detection BW < 0.3 radian peak for 30% AM at internal rates
Power Sweep Range	0 to -10 dB , 0.1 dB resolution
Tracking Generator Feedthrough* (System Performance)	Equal to the Standard System DANL (without 70300A), except where noted.
Exceptions:	
71210C:	$< -138 \text{ dBm}$ (10 MHz - 2.0 GHz); $< -135 \text{ dBm}$ (2.0 - 2.9 GHz)
71209A:†	$< -135 \text{ dBm}$ (2.0 - 2.9 GHz)
Scalar Dynamic Range	Compute using the following formula: S.D.R. = Maximum leveled power – TG feedthrough
Step Attenuator‡	
Attenuation Range:	0 to 70 dB in 10 dB steps
Repeatability:	$< \pm 0.2 \text{ dB}$ for any setting
Accuracy:	$\pm 1.0 \text{ dB}$ over full range (reference to 0 dB)
Output level:	-10 to -91 dBm
SWR: (characteristic)	$< 1.3:1$ with $\geq 10 \text{ dB}$ attenuation
<p>*TG feedthrough is defined as the displayed average noise level present with the TG set to Maximum Leveled Output Power and the TG output and RF input terminated in 50Ω loads. †Systems with preamps will not meet this specification. ‡Step-attenuator listings only apply to the HP 70300A RF tracking generators that have step attenuators.</p>	

**Table 3-3.
System Specifications and Characteristics with HP 70300A
RF Tracking Generator**

Parameters	Specifications and Characteristics
Spectral Purity	
FM:	<50 Hz rms (CW Mode, 50 Hz to 15 kHz video bandwidth)
AM:	-60 dBc at -10 dBm output level -40 dBc at -21 dBm output level (CW mode, 50 Hz to 15 kHz video bandwidth)
Harmonic Spurious at -10 dBm output:	<-30 dBc (10 MHz to 2.9 GHz) <-25 dBc (20 Hz to 10 MHz)
Non-Harmonic Spurious at -10 dBm output:	<-30 dBc (20 Hz to 2.0 GHz) <-20 dBc (2.0 GHz to 2.9 GHz)
RF Off Residuals	<-80 dBm <-120 dBm (at spectrum analyzer input frequency)
Sweep Time	
Range:	10 ms to 1000 s (with HP 70900B local oscillator source Local Oscillator) 50 ms to 1000 s (with HP 70900A local oscillator source)
Auto Sweep Time:	Valid for "typical" devices with span <20 × (DUT BW)

Table 3-4. General Specifications and Characteristics

Parameters	Specifications and Characteristics
Temperature	
Operation:	0°C to +55°C
Storage:	-40°C to +75°C
EMI*	Conducted and radiated interference is in compliance with CISPR publication 11 (1975) and FTZ 1046. Radiated interference is in compliance with MIL-STD 461B, Part 7, RE02.
<i>HP 70300A RF tracking generator Weight (characteristic)</i>	<i>5.0 kg (11 lb)</i>
<i>HP 70300A RF tracking generator Dimensions (characteristic)</i>	<i>2/8-width module</i>
<i>Height:</i>	<i>127 mm (5.0 in.)</i>
<i>Width:</i>	<i>96 mm (3.7 in.)</i>
<i>Length:</i>	<i>467 mm (18.4 in.)</i>
*Applies to systems only.	

Table 3-5.
HP 70300A RF Tracking Generator Input and Output Characteristics

Connectors	Characteristics
AM INPUT/OUTPUT (characteristic) <i>Input:</i> <i>Output:</i>	<i>BNC female</i> <i>600Ω impedance, cal % AM for 1 V peak input</i> <i>Maximum safe input level: 5 V peak</i> <i>20Ω impedance, 1 V peak ±5%</i> <i>Maximum safe reverse level: 5 V peak</i>
EXT ALC INPUT (characteristic)	<i>BNC female, 10 kΩ impedance, use with 0 to 100 mV input</i> <i>Negative detector; maximum safe input level: 20 V</i>
RF OUTPUT (characteristic)	<i>Type N female, 50Ω impedance</i> <i>Maximum safe reverse level: 1 W (30 dBm), 0 Vdc</i> <i>SWR (normal detection): <1.5:1 leveled</i> <i>SWR (alternate detection): <3.0:1 unleveled</i>
LO IN 3.0—6.6 GHz (characteristic)	<i>SMA female, 50Ω impedance, 0.5 dBm to 18 dBm maximum input</i>
LO OUT 3.0—6.6 GHz* (characteristic)	<i>SMA female, 50Ω impedance, 6 dBm to 14 dBm output</i>
3.6214 GHz OUT* (characteristic)	<i>SMA female, 50Ω impedance</i> <i>(Output level varies depending on RF output power level setting.)</i>
3.6214 GHz IN* (characteristic)	<i>SMA female, 50Ω impedance, -15 dBm maximum input</i>
0—2.9 GHz OUT (characteristic)	<i>SMA female, 50Ω impedance, <-5 dBm</i> <i>Maximum safe reverse level: 20 dBm, 0 Vdc</i> <i>20 Hz to 10 MHz (alternate detection)</i> <i>10 MHz to 2.9 GHz (normal detection)</i>
0—2.9 GHz IN (characteristic)	<i>SMA female, 50Ω impedance</i> <i>Maximum safe input level: 20 dBm, 5 Vdc</i>
300 MHz OUT (characteristic)	<i>SMB male, 50Ω impedance, 0 dBm ±1 dBm output</i>
300 MHz IN (characteristic)	<i>SMB male, 50Ω impedance, 0 dBm ±2 dBm input</i>
*These are present only in some earlier versions of the HP 70300A RF tracking generator.	

HP 70300A RF Tracking Generator Input and Output Characteristics

Connectors	Characteristics
21.4 MHz IN* <i>(characteristic)</i> <i>Input:</i> <i>Output:</i>	<i>SMB female</i> <i>50Ω impedance, < 5 dBm</i> <i>Maximum safe input level: 20 dBm, 40 Vdc</i> <i>50Ω impedance, -10 to -30 dBm</i> <i>Maximum safe reverse level: 20 dBm, 40 Vdc</i>
SWEEP IN <i>(characteristic)</i>	<i>SMB male, maximum input 40 V</i>
TUNE + SPAN IN <i>(characteristic)</i>	<i>SMB male, maximum input 40 V</i> <i>Level: 4.5 V to 10.2 V (1.5 V per GHz)</i>
HSWP IN <i>(characteristic)</i>	<i>SMB male, maximum input 40 V</i> <i>Level: TTL</i>
*21.4 MHz IN can be used as either an input or an output.	

Verification

This chapter describes module operation-verification tests that evaluate the electrical performance of an HP 70300A RF tracking generator in an HP 70000 Series modular measurement system. The software for these tests is on a Test Disk that is shipped with the HP 70300A RF tracking generator. This disk is used *along with* the HP 70900 operation verification software (Rev B.03.00 or greater) to verify the HP 70300A RF tracking generator's performance in a system. These tests need to be run after the HP 70300A RF tracking generator has been repaired or adjusted.

For information about equipment requirements and descriptions of the operation verification tests, refer to the *HP 70000 Modular Spectrum Analyzer Installation and Verification Manual*.

Explanation of Test Descriptions

The following list explains the information given for each test:

- “Tested Specification” is the name of the specification as found in the “Specifications” chapter of this manual.
- “Equipment” lists all external test equipment required by the particular test. Accessories are not listed. The test will not run if required test equipment is missing.
- “Equipment Setup” describes equipment interconnections. A setup screen on the computer display will also provide instruction. This screen does not appear if the current setup is complete and correct. The screen presents **ABORT** and **PROCEED** softkeys. Pressing **ABORT** will display the Test Menu. If the setup is wrong, pressing **PROCEED** three times will abort the test and then display the Test Menu.
- “Description” provides a brief description of the test.
- “In Case of Failure” tells which modules may need repair or adjustment if the test fails.

TG Absolute Amplitude Accuracy

for HP 70300A RF tracking generator

Tested Specification

AMPLITUDE ACCURACY: Absolute Accuracy
(using the normal and alternate detectors)

Equipment

Power Meter
RF Power Sensor

Equipment Setup

With the RF power-sensor output connected to the power meter, connect the input of the RF power sensor to the RF OUTPUT of the tracking generator.

Description

This test measures the RF OUTPUT amplitude accuracy of the tracking generator. The tracking generator is set to -10 dBm at 300 MHz and the RF OUTPUT is measured for amplitude accuracy with the normal detector enabled. The RF OUTPUT is again measured for amplitude accuracy at -10 dBm at 1 MHz, with the alternate detector enabled. Both frequency measurements are made with a single sweep in zero span.

In Case of Failure

If this test fails, the following modules may need repair or adjustment:

- Tracking Generator.

TG Vernier Accuracy

(for HP 70300A RF tracking generator)

Tested Specification

AMPLITUDE ACCURACY: Vernier Accuracy

Equipment

Power Meter
RF Power Sensor

Equipment Setup

With the RF power-sensor output connected to the power meter, connect the input of the RF power sensor to the RF OUTPUT of the tracking generator.

Description

This test measures the incremental RF output amplitude accuracy of the tracking generator over -21 dBm to -10 dBm, the range of the automatic level control (ALC).

The tracking generator frequency is set to 300 MHz, the ALC normal detector is selected, and the tracking generator's attenuator (if present) is set to 0 dB. The tracking generator output power is set to -10 dBm, and a reference reading is taken with the power meter. The output power is then stepped in 1 dB increments over the -21 dBm to -11 dBm range. The absolute error between the programmed amplitude (what was expected) and the power meter reading (what was measured) is stored. The differences in the absolute errors are checked to see if they meet incremental specifications.

The above procedure is repeated at 1 MHz with the ALC alternate detector.

In Case of Failure

If this test fails, the following modules may need repair or adjustment:

- Tracking Generator.

TG Frequency Response

(for HP 70300A RF tracking generator)

Tested Specification

AMPLITUDE ACCURACY: Amplitude Flatness
(using the normal and alternate detectors)

Equipment

Power Meter
RF Power Sensor

Equipment Setup

With the RF power-sensor output connected to the power meter, connect the input of the RF power sensor to the RF OUTPUT of the tracking generator.

Description

This test measures amplitude variation versus frequency of the tracking generator. The frequency range using the tracking generator normal detector is from 10 MHz to 2.9 GHz. For the alternate detector, the range tested is 100 kHz to 10 MHz.

A reference amplitude of -10 dBm is set at 300 MHz using the normal detector. The amplitude over the frequency range of the normal detector is increased in 60 linear steps from highest to lowest. Each step is measured for any deviation from the reference amplitude.

The same procedure is used to measure the amplitude deviation over the frequency range of the alternate detector, with the -10 dBm reference set at 1 MHz.

In Case of Failure

If this test fails, the following modules may need repair or adjustment:

- Tracking Generator.

TG Feedthru

(for HP 70300A RF tracking generator using HP 70902A IF section)

Tested Specification

TRACKING GENERATOR FEEDTHROUGH

Equipment

Power Meter
RF Power Sensor
50 Ohm Termination (HP 909D 50Ω 3.5 mm(m) termination only)

Note The type of 50Ω termination used can greatly affect the feedthrough level. BNC or Type N terminations have too much leakage, and should not be used. The leakage of the HP 909D 50Ω 3.5 mm(m) termination termination is low enough not to affect the measurement.

Equipment Setup

Setup A: Connect the RF OUTPUT of the tracking generator to the RF INPUT of the spectrum analyzer system.

Setup B: With the RF power-sensor output connected to the power meter, connect the input of the RF power sensor to the RF OUTPUT of the tracking generator. Connect the 50 ohm termination to the RF INPUT of the spectrum analyzer.

Description

The equipment is connected using setup A. The spectrum analyzer system containing the tracking generator is placed in Stimulus Response mode and set to the minimum IF resolution bandwidth, 10 Hz. Source track peaking is then performed to make sure that the source frequency is centered in the IF resolution bandwidth.

The equipment is connected using setup B. The tracking generator feedthrough level is then measured in each band of the spectrum analyzer using the following procedure:

1. The tracking generator is set for an RF output of -10 dBm.
2. The spectrum analyzer is set as follows:
 - Reference level of -65 dBm (-75 dBm when HP 70908A RF section is the RF section).
 - Resolution bandwidth of 10 Hz.
 - Attenuator setting of 0 dB.
 - Sample detection.
 - Stop and start frequencies are set for the band of interest.
3. A sweep is taken.
4. The tracking generator frequency is set to the frequency of the peak response, and a power meter is used to set the output amplitude to -10 dBm ± 0.05 dB.

TG Feedthru

5. The spectrum analyzer settings are changed as follows:

Span is set to 0 Hz.

Video bandwidth is set to 3 Hz.

Sweep time is set to a value which assures that the trace data elements are uncorrelated.

6. A sweep is taken.

The tracking generator feedthrough level is equal to the average of the trace elements. This procedure is repeated for each band of the spectrum analyzer.

In Case of Failure

If this test fails, the following modules may need repair or adjustment:

- Tracking Generator.
- RF Section.
- Preselector.

Troubleshooting

This chapter contains information about HP 70300A RF tracking generator front panel LEDs, and a listing of the error codes for the HP 70300A RF tracking generator. The information in this chapter is designed to help determine whether an error is being caused by the HP 70300A RF tracking generator. Make sure that the module has been properly addressed, is securely seated in the mainframe, and is correctly cabled.

After using the information in this chapter to verify that the problem is with the HP 70300A RF tracking generator, refer to the *HP 70300A/70301A Service Guide* for more detailed troubleshooting information.

If the error is not caused by the HP 70300A RF tracking generator, refer to the installation and verification manual for the system master (for example, HP 70900B local oscillator source) for more troubleshooting information.

Status/Error LEDs

The front panel status/error LEDs flash on, then off again, during the module's self-test. Listed below are the other reasons for each LED to light.

CAUTION When the AC COUPLED LED is lit, module damage may occur if the dc voltage level at the RF OUTPUT exceeds 25 V.

When the DC COUPLED LED is lit, module damage may occur if the dc voltage level at the RF OUTPUT exceeds 0 V.

The UNLEVELED LED will light when the reverse power at the RF OUTPUT is too high. Module damage may occur if the reverse power at the RF OUTPUT exceeds 1 W. Refer to UNLEVELED LED information below for the other conditions that will cause this LED to light.

ACT The ACT (active) LED lights when the module is activated by an HP 70000 Modular Measurement System master.

ERR The ERR (error) LED lights when an error condition exists. Some errors may only be present when the spectrum analyzer sweeps; these errors cause the ERR LED to flash at the sweep rate.

If the ERR LED flashes at a 1-Hz rate, HP-MSIB communication has been disrupted. It is possible for a module to disrupt the HP-MSIB communication without its own error indicator flashing. If more than one module in the system has its error indicator flashing at a 1-Hz rate, refer to the *HP 70000 Modular Spectrum Analyzer Installation and Verification Manual*.

AC COUPLED The AC COUPLED LED lights when the tracking-generator input attenuator is ac-coupled with a blocking capacitor in-line. Switching to ac-coupled is accomplished by selecting the *normal* detector mode. When **PRESET** is pressed, the RF output is always set to ac-coupled.

- DC COUPLED** The DC COUPLED LED lights when the tracking-generator input attenuator is dc-coupled (no blocking capacitor). Switching to dc-coupled is accomplished by selecting the *alternate* detector mode. The blocking capacitor can only be added or removed from the circuit by changing detectors.
- RF** The RF LED lights when the tracking-generator RF OUTPUT power is on. The RF LED will be lit when the **SRC PWR** softkey is set to **ON**.
- UNLEVELED** The UNLEVELED LED lights when the RF OUTPUT power is unlevelled. The following conditions can cause the RF OUTPUT power to be unlevelled:
- The source power or power sweep levels are set too high. Use the **SRC PWR** or **PWR SWP** softkeys to correct the levels. Refer to the operation manual supplement for the HP 70300A RF tracking generator for more information.
 - The normal ALC detector is used at a frequency below the normal detector range. Make sure that the dc voltage level at the RF OUTPUT is less than 0 V dc, then use the **ALC ALT** softkey to switch to alternate detector mode.
 - A malfunction in the RF signal path results in the output power being too low. Substitute modules, measure signal levels in the RF chain, or use the HP 70900A/B local oscillator source operation-verification software to determine which module is faulty. For more information, refer to the *HP 70000 Modular Spectrum Analyzer Installation and Verification Manual*.
 - The output is connected to a non-50Ω system.

Error Messages

The error messages generated by an HP 70300A RF tracking generator are listed in this section. The messages are grouped by functional category; each category has its own series of numbers. Interaction and dependencies can result in one problem causing multiple errors. Errors should be investigated in the order in which they are reported. For a complete list of all system error messages, refer to the Installation and Verification Manual for the system master.

Types	Numbers
Usage/Operating	2000 to 2999
Hardware Warning	6000 to 6999
Hardware Broken	7000 to 7999

Usage/Operating Errors

Usage and operating errors listed below are generated when an instrument is used incorrectly. This usually occurs during remote operation.

- 2001 **Illegal cmd** — User-generated system protocol error. This error occurs when the module encounters a command it does not recognize. This error can also be caused by a problem internal to the module, or an open cable between the system master and the tracking generator module. Isolate the problem by substituting system master, mainframe, and slave modules.
- 2002 **Illegal parameter** — User-generated system protocol error. This error occurs when the module encounters a command it does not recognize. This error can also be caused by a problem internal to the module, or an open cable between the system master and the tracking generator module. Isolate the problem by substituting system master, mainframe, and slave modules.
- 2006 **Param out of range** — User-generated system protocol error. This error occurs when the module encounters a command it does not recognize. This error can also be caused by a problem internal to the module, or an open cable between the system master and the tracking generator module. Isolate the problem by substituting system master, mainframe, and slave modules.
- 2008 **Output unlevelled** — The source power from the HP 70300A RF tracking generator is unlevelled. Either the selected output power is too high, the correct detector is not being used, the frequency selected is outside of the detector band (10 MHz to 2.9 GHz), or the 0 - 2.9 GHz OUT is not connected to the 0 - 2.9 GHz IN on the rear panel. For more information about automatic level control, refer to the operating and programming supplement for the HP 70300A RF tracking generator.
- 2009 **Protocol error** — User-generated system protocol error. This error occurs when the module encounters a command it does not recognize. This error can also be caused by a problem internal to the module, or an open cable between the system master and the tracking generator module. Isolate the problem by substituting system master, mainframe, and slave modules.
- 2042 **Not stored, A-x->A on** — The **A -- B -> A ON/OFF** and **A -- C -> A ON/OFF** softkeys must be OFF to store normalization data.

- 2043 LINEAR not allowed — If the instrument is in relative amplitude mode, LINEAR is not allowed. Relative amplitude mode is active when the trace math functions are active (A-B or A-C is ON) and STIMULS RESPON is active.
- 2044 Not stored, open 1st — If AVERAGE SHRT -> C is pressed before STORE OPEN -> C, this error message appears, as a reminder to store the open first.

Hardware Warning Errors

These error codes report the status of the HP 70300A RF tracking generator hardware. An error indicates that some of the hardware is not functioning properly. Measurement accuracy may be impaired.

- 6000 EAROM UNPROTECTED — The write-protect switch (on the top of the module) is in the ENABLE position. Use a non-metallic tool to switch it to the PROTECT position. If the write-protect switch is already set to the PROTECT position, the HP 70300A RF tracking generator hardware is faulty.
- 6008 Confidence test failed

Hardware Broken Errors

These error codes are generated by hardware or firmware failures within the module. Refer the *HP 70300A/70301A Service Guide* for more information.

- 7000 ROM CHECK ERROR — The checksum computed during module preset does not agree with the checksum stored in the module ROM #1.
- 7002 First LO Unleveled — Signal power at the output of the HP 70300A RF tracking generator's LO leveling amplifier is too low. Possible causes of this failure are low signal power at the HP 70300A RF tracking generator's rear panel LO IN 3.0–6.6 GHz connector, or faulty HP 70300A RF tracking generator hardware.
- 7003 Second LO Unlocked — The 3.3 GHz second LO is not “phased-locked” to the 300 MHz input signal. Possible causes of this failure are either low signal power or wrong frequency at the HP 70300A RF tracking generator's rear panel 300 MHz IN connector, or faulty HP 70300A RF tracking generator hardware.
- 7004 300 MHz Error — Low signal power of the 300 MHz signal into the HP 70300A RF tracking generator's third converter mixer. Possible causes of this failure are low signal power at the HP 70300A RF tracking generator's rear panel 300 MHz IN connector, or faulty HP 70300A RF tracking generator hardware.
- 7006 21.4MHz Error — Low signal power at the 21.4 MHz input of the HP 70300A RF tracking generator's third converter assembly. Possible cause of this failure is faulty HP 70300A RF tracking generator hardware.
- 7009 ROM #2 CHECKSUM ERROR — The checksum computed during module preset does not agree with the checksum stored in the module ROM #2.
- 7020 300 MHz AGC Error — Low signal power at the output of the HP 70300A RF tracking generator's 300 MHz leveling amplifier. Possible causes of this failure are either low signal power at the HP 70300A RF tracking generator's rear panel 300 MHz IN connector, or faulty HP 70300A RF tracking generator hardware.

Index

A

Accessories, 1-2
Addressing the Module , 2-2
address map, 2-2
address switches, 2-3

C

cables
 HP part number, 1-2
Checking for Error Messages, 2-12
Checking Module Operation , 2-12
Connecting the Module-Interconnect Cables
 , 2-5

D

Determining the HP-MSIB Address, 2-2

E

error indicator lights, 5-1
Error Messages, 5-3
error messages,, 5-4
external signal generator, 1-5

F

firmware
 upgrade, 1-2
Firmware Compatibility, 1-2
Front-Panel and Rear-Panel Features , 1-3
Front-Panel Inputs and Outputs, 1-4
front panel status and error LEDs, 5-1
Front-Panel Status/Error LEDs , 1-3

H

Hardware Broken Errors, 5-4
Hardware Warning Errors, 5-4
HP 70300A RF tracking generator
 cable connections, 2-5
 frequency range, vii
 installing in mainframe, 2-4
 operation-verification tests, 4-1
 option 099, 1-2
 power-on self-test, 2-12
 step attenuator, vii
HP 71100A Modular Spectrum Analyzer with
 an HP 70300A RF Tracking Generator ,
 2-7

HP 71210A Microwave Spectrum
 Analyzer with an HP 70300A
 RF Tracking Generator and an
 HP 70301A Microwave Tracking
 Generator, 2-9

HP-MSIB

 address, 2-2, 2-3
 connection, 1-5

I

Initial Inspection , 1-1
Installing the Module in the Mainframe , 2-4

L

LO firmware version, 1-2

M

Manual Conventions , 1-1
manual organization, viii
Module Latch , 1-4
module, serial numbers, 1-7

O

Observing the Front-Panel LEDs, 2-12
operation-verification tests, 4-1

P

power-on self-test, 2-12

R

Rear-Panel Inputs and Outputs , 1-4

S

Safety Considerations , 1-1
serial numbers, module, 1-7
Setting the HP-MSIB Address Switches , 2-3
Status/Error LEDs, 5-1

T

tracking generator configuration, 2-1
tracking generator-interconnect cable
 connections, 2-5
tracking generator-operation checks, 2-12

U

Usage/Operating Errors, 5-3

