



HEWLETT  
PACKARD

## Installation and Verification Manual

# HP 70205A and HP 70206A GRAPHICS DISPLAY

### SERIAL NUMBERS

This manual applies directly to HP 70205A and HP 70206A graphics display with serial numbers prefixed 2731A and below.

COPYRIGHT © 1989 HEWLETT-PACKARD COMPANY  
1212 VALLEY HOUSE DRIVE, ROHNERT PARK, CALIFORNIA 94928-4999, USA

Manual Part Number: 70206-90022  
Microfiche Part Number: 70206-90023

Printed: August 1989

---

## Certification

*Hewlett-Packard Company certifies that this product met its published specifications at the time of shipment from the factory. Hewlett-Packard further certifies that its calibration measurements are traceable to the United States National Institute of Standards and Technology, to the extent allowed by the Institute's calibration facility, and to the calibration facilities of other International Standards Organization members.*

## Warranty

This Hewlett-Packard instrument product is warranted against defects in material and workmanship for a period of one year from date of shipment. During the warranty period, Hewlett-Packard Company will, at its option, either repair or replace products which prove to be defective.

For warranty service or repair, this product must be returned to a service facility designated by HP. Buyer shall prepay shipping charges to HP and HP shall pay shipping charges to return the product to Buyer. However, Buyer shall pay all shipping charges, duties, and taxes for products returned to HP from another country.

HP warrants that its software and firmware designated by HP for use with an instrument will execute its programming instructions when properly installed on that instrument. HP does not warrant that the operation of the instrument, or software, or firmware will be uninterrupted or error-free.

### *LIMITATION OF WARRANTY*

The foregoing warranty shall not apply to defects resulting from improper or inadequate maintenance by Buyer, Buyer-supplied software or interfacing, unauthorized modification or misuse, operation outside of the environmental specifications for the product, or improper site preparation or maintenance.

NO OTHER WARRANTY IS EXPRESSED OR IMPLIED. HP SPECIFICALLY DISCLAIMS THE IMPLIED WARRANTIES OF MERCHANTABILITY AND FITNESS FOR A PARTICULAR PURPOSE.

### *EXCLUSIVE REMEDIES*

THE REMEDIES PROVIDED HEREIN ARE BUYER'S SOLE AND EXCLUSIVE REMEDIES. HP SHALL NOT BE LIABLE FOR ANY DIRECT, INDIRECT, SPECIAL, INCIDENTAL, OR CONSEQUENTIAL DAMAGES, WHETHER BASED ON CONTRACT, TORT, OR ANY OTHER LEGAL THEORY.

## Assistance

*Product maintenance agreements and other customer assistance agreements are available for Hewlett-Packard products.*

*For any assistance, contact your nearest Hewlett-Packard Sales and Service Office.*

---

## **Read This First**

---

### **HP 70205A and HP 70206A GRAPHICS DISPLAY**

#### **Installation and Verification Manual**

**HP Part Number: 70206-90022**

This manual was designed to be inserted into and used with your existing HP 70000 Modular Measurement System's documentation. Use the following instructions to insert this manual into the Installation and Verification Manual for the system master (for instance, the HP 70900B Local Oscillator module).

1. Remove the shrink wrapping covering this manual.
2. Remove the tab provided and place it at the end of the master's Installation and Verification Manual.
3. Place this manual behind the tab that was added in step 2.

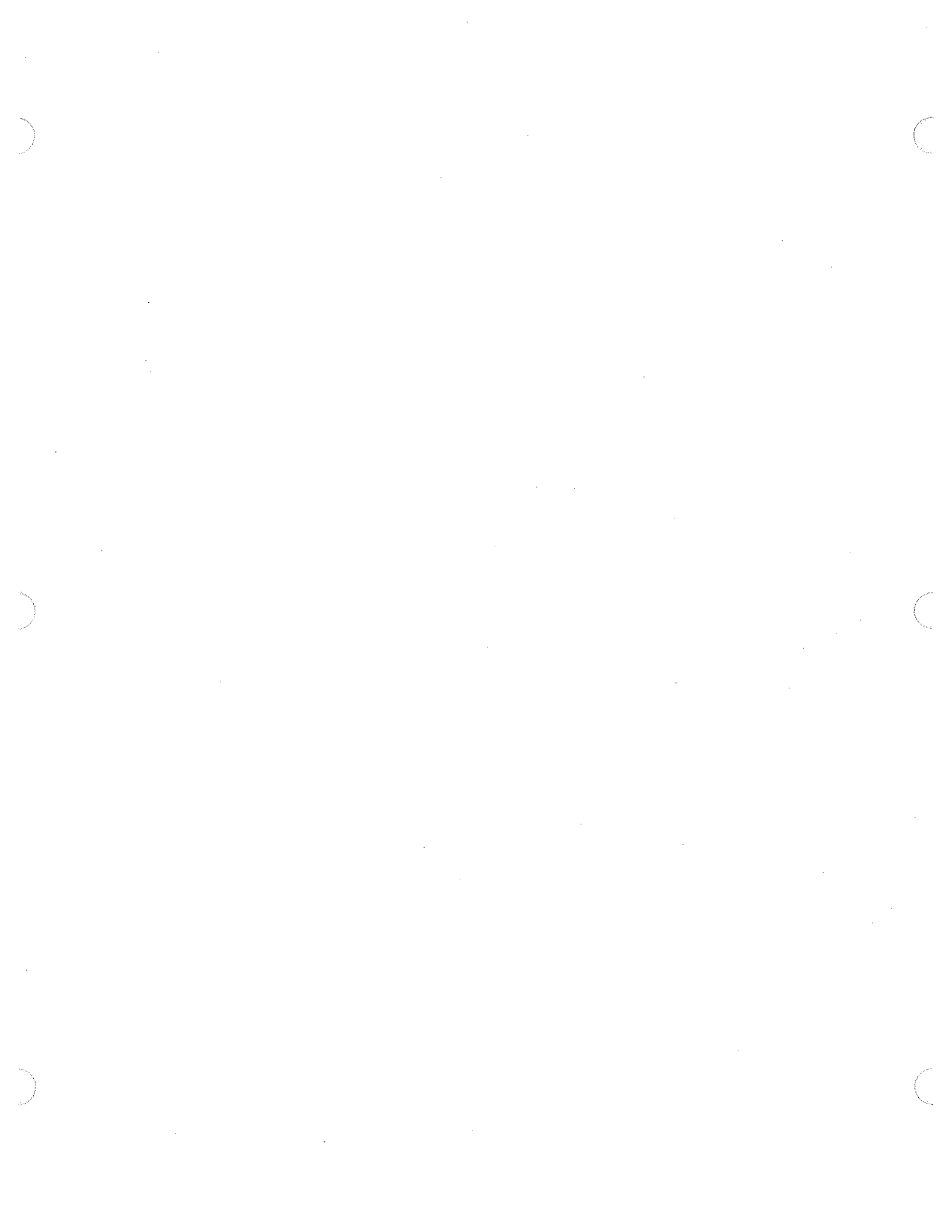

# Notice

---

## Hewlett-Packard to Agilent Technologies Transition

This documentation supports a product that previously shipped under the Hewlett-Packard company brand name. The brand name has now been changed to Agilent Technologies. The two products are functionally identical, only our name has changed. The document still includes references to Hewlett-Packard products, some of which have been transitioned to Agilent Technologies.

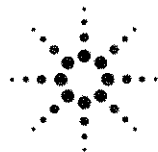

**Agilent Technologies**



---

## Safety Symbols

The following safety symbols are used throughout this manual. Familiarize yourself with each of the symbols and its meaning before operating this instrument.

---

### Caution



The CAUTION sign denotes a hazard. It calls attention to a procedure which, if not correctly performed or adhered to, could result in damage to or destruction of the instrument. Do not proceed beyond a CAUTION sign until the indicated conditions are fully understood and met.

---

### Warning



The WARNING sign denotes a hazard. It calls attention to a procedure which, if not correctly performed or adhered to, could result in injury or loss of life. Do not proceed beyond a WARNING sign until the indicated conditions are fully understood and met.

---

## General Safety Considerations

---

### Warning



**BEFORE THIS INSTRUMENT IS SWITCHED ON**, make sure it has been properly grounded through the protective conductor of the ac power cable to a socket outlet provided with protective earth contact. Any interruption of the protective (grounding) conductor, inside or outside the instrument, or disconnection of the protective earth terminal can result in personal injury.

---

### Warning



There are voltages at many points in the instrument which can, if contacted, cause personal injury. Be extremely careful. Any adjustments or service procedures that require operation of the instrument with protective covers removed should be performed only by trained service personnel.

---

### Caution



**BEFORE THIS INSTRUMENT IS SWITCHED ON**, make sure its primary power circuitry has been adapted to the voltage of the ac power source. Failure to set the ac power input to the correct voltage could cause damage to the instrument when the ac power cable is plugged in.

---

---

# HP 70000 Modular Measurement System Documentation Outline

Instruments and modules of the HP 70000 Modular Measurement System are documented to varying levels of detail. Modules that serve as masters of an instrument require operation information in addition to installation and verification instructions. Modules that function as slaves in a system require only a subset of installation and verification information.

## Manuals Supplied with Module

### Installation and Verification Manual

Topics covered by this manual include installation, specifications, verification of module operation, and some troubleshooting techniques. Manuals for modules that serve as instrument masters will supply information in all these areas; manuals for slave modules will contain only information needed for slave module installation and verification. Master module documentation may also include some system-level information.

### Operation Manual

Operation Manuals usually pertain to multiple- and single-module instrument systems. Topics include preparation for module use, module functions, and softkey definitions.

### Programming Manual

Programming Manuals also pertain to multiple- and single-module instrument systems. Programming Manual topics include programming fundamentals and definitions for remote programming commands.

## Service Manual, Available Separately

This manual provides service information for a module, including module verification tests, adjustments, troubleshooting, replaceable parts lists, and replacement procedures. For ordering information, contact a Hewlett-Packard Sales and Service Office. This manual is not always immediately available for new products. (NOTE: Some earlier service manuals are titled *Technical Reference*.)



# Contents

---

## 1. General Information

Introduction . . . . .	1-1
Notation . . . . .	1-1
Modular Measurement Terms Used in This Manual . . . . .	1-1
Functional Terms . . . . .	1-2
Structural Terms . . . . .	1-2
Display Description . . . . .	1-2
Safety Considerations . . . . .	1-3
Displays Covered by This Manual . . . . .	1-3
Serial Numbers . . . . .	1-3
Manual Updating Supplement . . . . .	1-4
Initial Inspection . . . . .	1-4
Accessories . . . . .	1-5
Options . . . . .	1-6
400 Hz Option (HP 70206A System Graphics Display) . . . . .	1-6
Rack-Mount Installation (HP 70206A System Graphics Display) . . . . .	1-6
Bench Operation . . . . .	1-6
Rack-Mounting the HP 70206A Display . . . . .	1-7
Rack-Mounting with Slides . . . . .	1-7
Interconnecting Instrument Cabinets . . . . .	1-9
Replacing the Battery . . . . .	1-10
Front/Rear-Panel Features . . . . .	1-11
HP 70205A Graphics Display Front-Panel Features . . . . .	1-11
HP 70205A Graphics Display Rear-Panel Features . . . . .	1-12
Rear Panel Outputs . . . . .	1-12
HP 70206A System Graphics Display Front-Panel Features . . . . .	1-13
HP 70206A System Graphics Display Rear-Panel Features . . . . .	1-14
Rear Panel Inputs/Outputs . . . . .	1-14
Display Screen Cleaning . . . . .	1-15
Electrostatic Discharge Information . . . . .	1-15
Hazards of Internal Repair and Adjustment . . . . .	1-15
Reducing ESD Damage . . . . .	1-16
Care and Handling of Electronic Components . . . . .	1-16
Static-Safe Accessories . . . . .	1-17
Sales and Service Offices . . . . .	1-17
Returning Instruments for Service . . . . .	1-19
Packaging . . . . .	1-19
Instrument Shipping Preparation Procedure. . . . .	1-19

<b>2. Installation</b>	
Introduction	2-1
Installation of the HP 70205A Graphics Display Module	2-2
Addressing the HP 70205A Graphics Display	2-2
Determining the HP-MSIB Address	2-2
Setting the HP-MSIB Address Switches	2-3
Setting the HP-IB Switch	2-3
Display Address Switches	2-3
Installing the HP 70205A in the Mainframe	2-5
Module Installation	2-5
Installation of the HP 70206A System Graphics Display	2-6
Line Voltage Selector	2-6
Fuse Replacement	2-7
Addressing the HP 70206A System Graphics Display	2-7
Determining the HP-MSIB Address	2-7
Setting the HP-MSIB Address Switches	2-8
Setting the HP-IB Switch	2-9
Display Address Switches	2-9
Connecting the Display to a Mainframe	2-10
Remote Operation	2-11
400 Hz Option	2-12
Intensity Adjustments	2-12
<b>3. Specifications</b>	
Introduction	3-1
Specifications	3-1
Nominal Values	3-1
HP 70205A Graphics Display Specifications	3-2
General	3-2
Rear-Panel Output	3-2
HP 70206A System Graphics Display Specifications	3-3
General	3-3
Rear-Panel Output	3-3
<b>4. Verification</b>	
Introduction	4-1
Power-On Self-Test	4-1
Confidence Test ( <u>CONFID TEST</u> Softkey)	4-1
HP 70206A System Graphics Display Fault Indicator	4-1
<b>5. Troubleshooting</b>	
Introduction	5-1
Turn-On	5-1
HP 70205A Graphics Display	5-1
HP 70206A System Graphics Display	5-1
HP 70206A Line Fuse	5-2
Fault Indicators	5-2
HP 70205A Fault Indicator	5-2
Blinking E	5-2
HP 70206A Fault Indicators	5-3
Blinking E	5-3

I/O Indicator Light . . . . .	5-4
Using the HP-MSIB Troubleshooting Utility . . . . .	5-6
Preparing to Use the Utility . . . . .	5-6
Using the Utility . . . . .	5-7
Interpreting the Utility Results . . . . .	5-10
Blank or Distorted Display . . . . .	5-11
Display Tests . . . . .	5-12
Test Pattern Softkeys . . . . .	5-13
Display ID Softkey . . . . .	5-13
Knob Test Softkey . . . . .	5-14
Key Test Softkey . . . . .	5-15
Confidence Test ( <del>CONFID TEST</del> Softkey) . . . . .	5-16
Tumble Figures Softkey . . . . .	5-17
Error Codes and Messages . . . . .	5-18
2000—2999 Usage Errors . . . . .	5-18
2001 Illegal Command . . . . .	5-18
2002 Illegal Parameter . . . . .	5-18
2005 Illegal character set . . . . .	5-18
2006 Parm out to Range . . . . .	5-18
2007 Missing terminator . . . . .	5-18
2009 Protocol error . . . . .	5-18
2011 Memory overflow . . . . .	5-19
Display-Disruptive Error Messages . . . . .	5-19
A3 CALL FAILED (ROM Version 6.0 and later) . . . . .	5-19
A3 CHAR ROM (ROM Version 6.0 and later) . . . . .	5-19
A3 CHAR ROM (ROM Version 5.0) . . . . .	5-19
A3 CHAR SET (ROM Version 6.0 and later) . . . . .	5-19
A3 COND WRITE . . . . .	5-19
A3 DOT WRITE . . . . .	5-19
A3 LIMITS ERR . . . . .	5-19
A3 MARK FAILED . . . . .	5-19
A3 MEMORY ADDRESS . . . . .	5-20
A3 MEMORY ARB . . . . .	5-20
A3 RETURN FAILED . . . . .	5-20
A3 MEMORY R/W . . . . .	5-20
A3 MEMORY READ . . . . .	5-20
A3 MEMORY SYNC . . . . .	5-20
A3 MEMORY WRITE . . . . .	5-20
A3 SERIAL INTERFACE . . . . .	5-20
A3 START VECTOR . . . . .	5-20
A3 WORD WRITE . . . . .	5-21
A3 WRONG DATE CODE . . . . .	5-21
A3 ??? FAILED (ROM Version 5.0) . . . . .	5-21
A3 UNKNOWN (ROM Version 6.0 and later) . . . . .	5-21
A4 PIXEL RAM . . . . .	5-21
A6 RAM ADDR ERROR . . . . .	5-21
A6 RAM DATA ERROR (LOW) (ROM Version 5.0) . . . . .	5-21
A6 RAM DATA ERROR (HIGH) (ROM Version 5.0) . . . . .	5-21
A6 RAM DATA ERROR (U37) (ROM Version 6.0 and later) . . . . .	5-21
A6 RAM DATA ERROR (U38) (ROM Version 6.0 and later) . . . . .	5-21

A6 ROM CHECKSUM 3,2,1 and/or 0 (ROM Version 5.0)	5-21
A6 ROM 39 CHECKSUM (ROM Version 6.0 and later)	5-21
A6 ROM 40 CHECKSUM (ROM Version 6.0 and later)	5-21
A6 ROM 47 CHECKSUM (ROM Version 6.0 and later)	5-21
A6 ROM 48 CHECKSUM (ROM Version 6.0 and later)	5-21
A6 8041 INTERFACE	5-22
A6 Exception-Processing Errors	5-22
6000-6999 Hardware-Warning Errors	5-22
6002 A6 RAM checksum (ROM Version 5.0)	5-22
6002 A6 RAM checksum (battery?) (ROM Version 6.0 and later)	5-22
6008 Confidence Test Failed	5-22
7000-7999 Hardware-Broken Errors	5-22
7036 HP-MSIB error	5-22
7037 A3 Char ROM (ROM Version 5.0)	5-23
7037 A3 Character set (ROM Version 6.0 and later)	5-23
7038 A6 Error in 8041	5-23
7039 A4 Memory	5-23
7040 A3 Dot gen	5-23
7048 A3 Wrong datecode	5-23
7068 A3 Conditional write	5-23
7069 A3 Word write	5-23
7070 A3 Dot write	5-23
7071 A3 Limit error	5-23
7072 A3 Memory arbitration	5-24
7049 A3 Character ROM (ROM Version 6.0 and later)	5-24
7050 A3 Sub return	5-24
7051 A3 Instruction mark	5-24
7052 A3 Unknown failure	5-24
7053 A3 Subroutine call	5-24
7054 A3 Memory sync	5-24
7055 A3 Serial interface	5-24
7056 A3 Memory read	5-24
7057 A3 Memory write	5-24
7058 A3 Memory R/W	5-25
7059 A3 Memory address	5-25
7060 A6 RAM Data (U37)	5-25
7061 A6 RAM Data (U38)	5-25
7062 A6 RAM Address	5-25
7063 A6 ROM U39 Checksum	5-25
7064 A6 ROM U40 Checksum	5-25
7065 A6 ROM U47 Checksum	5-25
7066 A6 ROM U48 Checksum	5-25
7067 A3 Start vector	5-25

## Index

## Figures

---

1-1. Typical Serial Number Label . . . . .	1-3
1-2. Front Handle Removal and Rack-Mounting . . . . .	1-8
1-3. Interconnecting System II Cabinets . . . . .	1-9
1-4. Replacing the Battery . . . . .	1-10
1-5. HP 70205A Graphics Display Front-Panel Features . . . . .	1-11
1-6. HP 70205A Graphics Display Rear-Panel Features . . . . .	1-12
1-7. HP 70206A System Graphics Display Front-Panel Features . . . . .	1-13
1-8. HP 70206A System Graphics Display Rear-Panel Features . . . . .	1-14
1-9. Example of a Static-Safe Work Station . . . . .	1-16
1-10. Packaging Material for the HP 70205A . . . . .	1-20
1-11. Packaging Material for the HP 70206A . . . . .	1-21
2-1. HP 70205A Graphics Display Address Map . . . . .	2-2
2-2. Module Address Switches . . . . .	2-4
2-3. Module Installation . . . . .	2-5
2-4. Line Voltage Selector (Shown in 115 V Position) . . . . .	2-6
2-5. Fuse Removal and Replacement . . . . .	2-7
2-6. HP 70206A System Graphics Display Address Map . . . . .	2-8
2-7. Display Address Switches . . . . .	2-10
2-8. HP-MSIB Cabling Example . . . . .	2-11
5-1. HP 70205A Front-Panel Fault Indicators . . . . .	5-3
5-2. HP 70206A Front-Panel Fault Indicators . . . . .	5-5
5-3. Knob Test Display . . . . .	5-7
5-4. HP-MSIB Troubleshooting Utility . . . . .	5-8
5-5. Alphabetical Softkeys . . . . .	5-9
5-6. Completed HP-MSIB Communication . . . . .	5-10
5-7. <b>display tests</b> Softkey . . . . .	5-12
5-8. <b>display tests</b> Screen . . . . .	5-13
5-9. Display ID . . . . .	5-14
5-10. Knob Test Display . . . . .	5-15
5-11. Key Test . . . . .	5-16
5-12. Confidence Test . . . . .	5-17

## Tables

---

1-1. Accessories Supplied for the HP 70206A . . . . .	1-5
1-2. Optional Accessories for the HP 70206A Display . . . . .	1-5
1-3. Options for the HP 70206A . . . . .	1-6
1-4. Static-Safe Accessories . . . . .	1-17
1-5. Hewlett-Packard Sales and Service Offices . . . . .	1-18
2-1. Decimal Equivalents of Binary Addresses . . . . .	2-3
2-2. Decimal Equivalents of Binary Addresses . . . . .	2-8
5-1. Decimal/Hexadecimal Conversion . . . . .	5-9

## General Information

---

### Introduction

The *HP 70205A and HP 70206A Installation and Verification Manual* contains information needed to install and verify operation of the HP 70205A and HP 70206A graphics displays. For information on installing and verifying HP 70000 Modular Measurement Systems, refer to the Installation and Verification Manual for your instrument (for example, spectrum analyzer).

This manual contains the following five chapters:

- Chapter 1, “General Information,” describes both the HP 70205A Graphics Display and the HP 70206A System Graphics Display and their accessories, gives electrostatic discharge and packaging information, and lists Hewlett-Packard Sales and Service Offices.
- Chapter 2, “Installation,” provides information for preparing a display for use and configuring the display into HP 70000 Modular Measurement Systems.
- Chapter 3, “Specifications,” lists display specifications and characteristics.
- Chapter 4, “Verification,” contains tests required to verify display specifications.
- Chapter 5, “Troubleshooting,” explains the probable cause(s) of faults and problems indicated by front-panel fault indicators, and provides diagnosis and problem isolation techniques to help resolve these problems.

### Notation

Throughout the *HP 70205A and HP 70206A Installation and Verification Manual*, softkey labels are denoted as **TEXT**. Fixed-label keys are referred to as “hardkeys” and are denoted as **TEXT**. Hardkey labels on the HP 70205A differ slightly from hardkey labels on the larger HP 70206A. For example, on the HP 70206A the display hardkey is denoted as **DISPLAY**, while the same hardkey on the HP 70205A the manual is abbreviated **DSP**. The key functions are identical. The HP 70206A hardkey labels are used throughout this manual.

### Modular Measurement Terms Used in This Manual

Understanding the following terms is essential to understanding the structural relationship of the HP 70000 Modular Measurement System devices.

## Functional Terms

The devices of a modular system may be combined in such a way to allow them to communicate and operate as an instrument. The following terms identify the interrelationship among devices within a modular instrument.

- **Element:** Any device that communicates over the Hewlett-Packard Modular System Interface Bus (HP-MSIB), for example, the HP 70902A IF section. In contrast, the HP 70001A Mainframe controls all HP-MSIB communication, but does not communicate over the HP-MSIB and therefore is not an element.
- **Master:** A module that controls other modules.
- **Sub-Master:** An element that other elements control and simultaneously controls other elements.
- **Slave:** A module that another module controls.
- **Independent element:** An element that is neither a master nor a slave (for example, the HP 70205A Graphics Display).
- **Instrument:** A module, or group of modules, that performs an independent function (for example, the HP 71100C Spectrum Analyzer).

## Structural Terms

Modular systems consist of hardware structures dedicated to specific functions. The structural terms used in reference to these functions are described below.

- **Mainframe:** A mainframe is the device into which plug-in modules may be installed to create an instrument such as a modular measurement system.
- **Module:** Modules are devices that plug into a mainframe. They cannot function without a mainframe.
- **Stand-Alone Instrument:** An HP-MSIB element capable of performing its functions without a mainframe (for example, the HP 70206A System Graphics Display).

---

## Display Description

The HP 70205A Graphics Display (a 3/8-width module) and HP 70206A System Graphics Display (a free-standing instrument with a 9-inch CRT) are menu-driven human interfaces for the HP 70000 Modular Measurement System. They display system configuration information, measurement results, text, graphics, and include built-in trace and marker capabilities. Softkeys are used to establish an interactive front panel for any modular instrument.

The HP 70206A System Graphics Display may be stacked or racked with the HP 70001A Mainframe.



---

## Safety Considerations

Before operating the display, familiarize yourself with any safety markings on the display and the safety instructions in this manual. This instrument has been manufactured and tested according to international safety standards. The cautions and warnings in this manual and on the display must be followed to ensure the safe operation of the displays and protection of personnel. Refer to the summary of safety considerations at the front of this manual.

---

## Displays Covered by This Manual

The contents of this manual apply to HP 70205A and HP 70206A displays with the serial number prefix(es) listed under “Serial Numbers” on the manual title page.

### Serial Numbers

Attached to the rear-panel of each display is a mylar serial-number label. The serial number is divided into two parts. The first four digits and a letter are the serial-number prefix, and the last five digits are the suffix. See Figure 1-1.

The prefix is coded for the date of the last configuration change and is the same for all identical displays; a prefix break or change only occurs when a significant modification is made to the product. The letter designates the country of origin. The suffix is assigned sequentially and is different for each display.

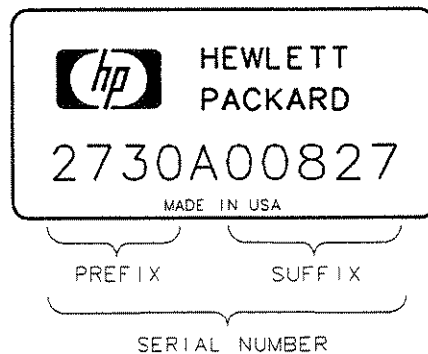

**Figure 1-1. Typical Serial Number Label**

---

## Manual Updating Supplement

A display manufactured before or after this manual was printed may have a serial-number prefix other than that listed under "Serial Numbers" on the manual title page. A lower serial-number prefix means that all current changes may not have been made to this display. A higher serial-number prefix means that changes have been made to the display since the manual was printed. These changes are documented in the Manual Updating Supplement for this manual. The Manual Updating Supplement may also contain information for correcting errors in the manual. To keep the manual as current and accurate as possible, periodically request the latest Manual Updating Supplement for this manual from your nearest Hewlett-Packard Sales and Service office.

---

## Initial Inspection

Inspect the shipping container for damage. If the shipping container or cushioning material is damaged, the shipping container or cushioning material should be kept until the contents of the shipment have been checked for completeness and the display has been checked mechanically and electrically. Refer to Table 1-1 to determine what accessories should have been shipped with the display. If the shipping contents are incomplete or damaged, notify the nearest Hewlett-Packard Sales and Service Office.

---

## Accessories

The accessories supplied with an HP 70206A display or as part of a preconfigured HP 70000 Modular Measurement System are the same. The accessories may be ordered separately. These accessories are listed in Table 1-1. Contact the nearest Hewlett-Packard Sales and Service Office for a description of all power cables currently available for different country destinations.

**Table 1-1. Accessories Supplied with the HP 70206A**

Accessory	HP Part Number
HP-MSIB Cables	70800A (0.5mm)
Power Cable	Part number depends on country of destination

**Table 1-2. Optional Accessories for the HP 70206A Display**

HP-MSIB Cables Length	HP Part Number
0.5 mm	70800A
1.0 mm	70800B
2.0 mm	70800C
6.0 mm	70800D
30.0 mm	70800E

For longer HP-MSIB cables, contact your nearest Hewlett-Packard Sales and Service Office.

---

## Options

The following options are available and can be ordered from the nearest Hewlett-Packard Sales and Service Office.

**Table 1-3. Options for the HP 70206A**

Option number	Description	HP Part Number
400	400 Hz Input Isolation Transformer	70206-60047
913	Rack mount with handles	5061-9678
908	Rack mount without handles	5061-9684
010	Rack slide	1494-0059
W30	Two Year (2) Additional Return-to-HP Service	
	Cabinet Interconnect Kit Display to Mainframe	5061-9061

### 400 Hz Option (HP 70206A System Graphics Display)

The display is available with an option that allows it to run on a power-line frequency of 400 Hz. Option 400 uses an external in-line transformer for user with a 400 Hz power source. Refer to Table 1-3 for ordering information.

---

#### Warning



**DO NOT operate a 400 Hz Option instrument on a 400 Hz power line without the attached in-line isolation transformer. Failure to follow this precaution can result in personal injury.**

---

The in-line isolation transformer must be removed for 60 Hz power-source operation. Failure to remove the in-line transformer may result in a blown fuse. When you remove the isolation transformer, use a standard power cord. Reinstall the in-line isolation transformer for use with a 400 Hz power source. This protects the user from shock hazard.

### Rack-Mount Installation (HP 70206A System Graphics Display)

#### Bench Operation

Plastic feet and a fold-away tilt stand are included with the HP 70206A display to provide bench operation convenience. The plastic feet are designed to be self-aligning when systems are stacked.

---

#### Note



Be sure to use the correct hardware when replacing part, since both metric and English hardware are used with these instruments.

---

## Rack-Mounting the HP 70206A Display

Front handles must be removed to install system rack-mounting options. See Figure 1-2

---

### Caution



Do not rack-mount multiple HP 70206A displays and HP 70001A Mainframes with one rack-mount hardware kit. One rack-mount kit must be ordered for each display and mainframe.

---

Option 908 (Rack Flange Kit without handles), and Option 913 (Rack Flange Kit with handles), contain the necessary hardware for mounting instruments in a rack with 482.6 mm (16 inches) spacing.

Figure 1-2 provides rack-mount option screw sizes and handle or bracket positioning for proper rack-mount installation. Angle brackets (HP part number 12679C) may be ordered to provide the additional rear and side support required of a mounted instrument.

### Rack-Mounting with Slides

Option 011, Rack-Mount with Slides for the HP 70206A display, contains the necessary hardware to attach slides to a stand-alone display and mount it to a rack with 482.6 mm (19 inch) spacing. Slide rack-mount adapter kits are available for non-HP racks. Installation instructions are included with each kit.

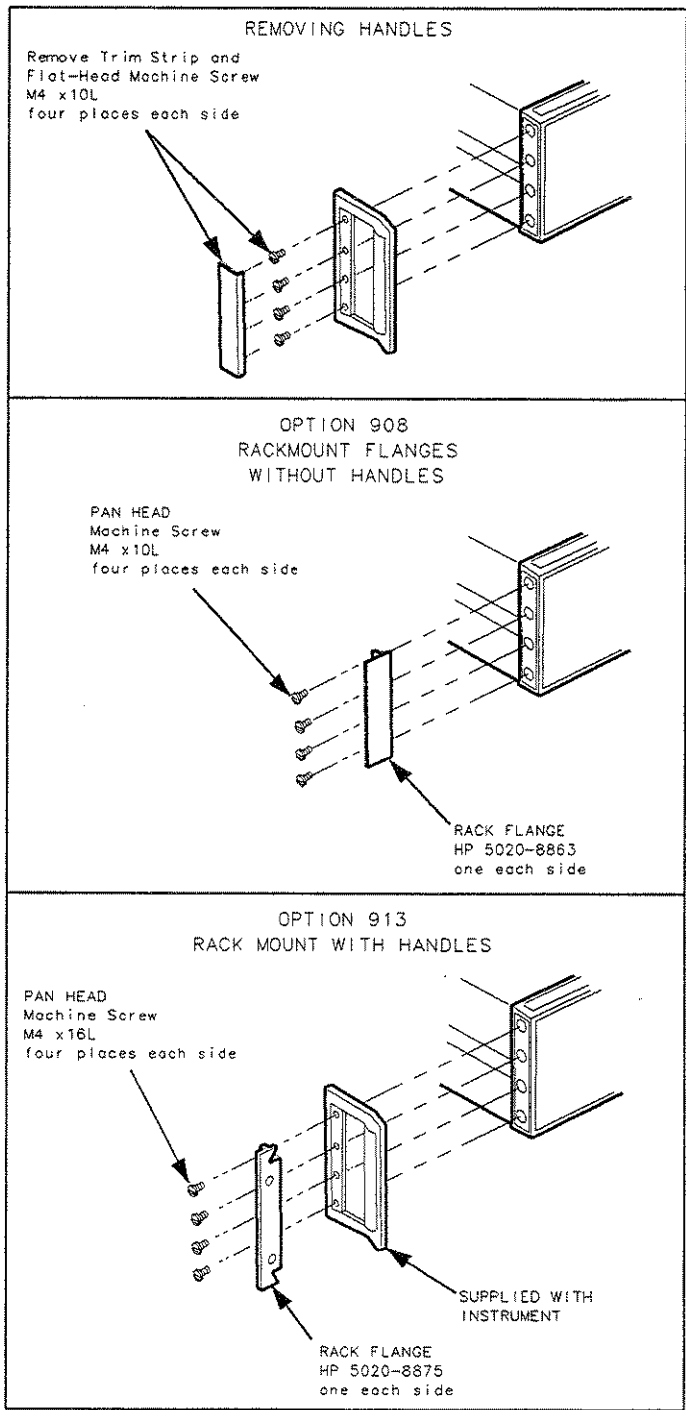

NOTE: LEFT FRONT IS SHOWN IN EACH EXAMPLE.

**Figure 1-2. Front Handle Removal and Rack-Mounting**

## Interconnecting Instrument Cabinets

### Caution



The HP 70206A System Graphics Display and the HP 70001A Mainframe use metric 4.0 screws. Other System II cabinets use metric 3.5 or English 6-32 screws. Using incorrect screw sizes may damage the instrument cabinet.

Refer to Table 1-3 for the part numbers of System II Cabinet Interconnect Kits.

Figure 1-3 illustrates the kit hardware used for vertically interconnecting System II cabinets. The kit contains both metric and English screws. The screws cover all mainframe and System II cabinet combinations.

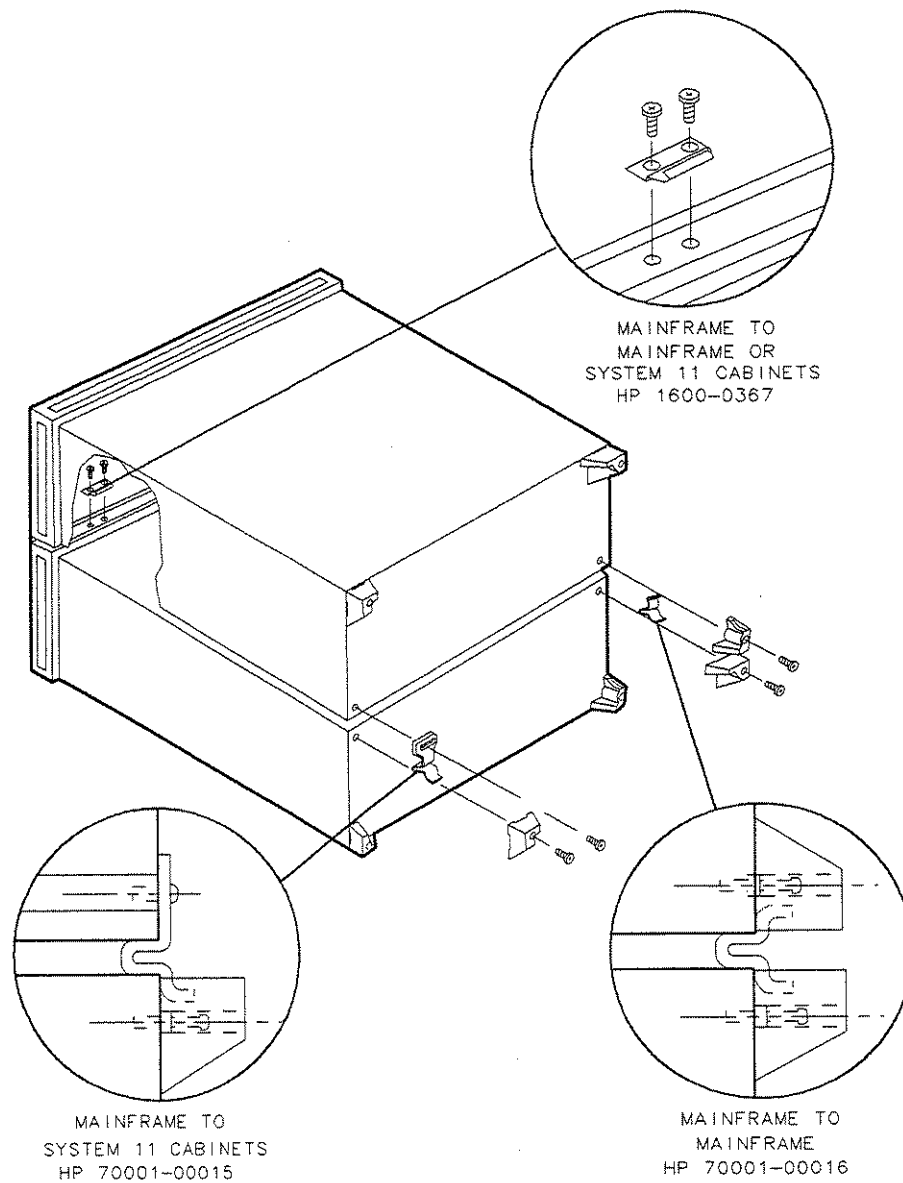

Figure 1-3. Interconnecting System II Cabinets

---

## Replacing the Battery

---

### Warning



The BT1 Battery must not be recharged, forced open, or disposed of in fire. If abused, this battery represents a fire, explosion, or severe burn hazard. Dispose of the battery in accordance with local-hazardous-material disposal regulations.

---

1. To remove the battery, remove the two screws on the rear-panel securing the battery cover and remove the cover.
2. Remove the battery
3. Replace the battery, positive (+) end in.
4. Replace the battery cover. Replace the two battery cover screws and tighten them to 6 inch-pounds.
5. Turn the power ON, wait 15 seconds, turn the display OFF, then back ON again.

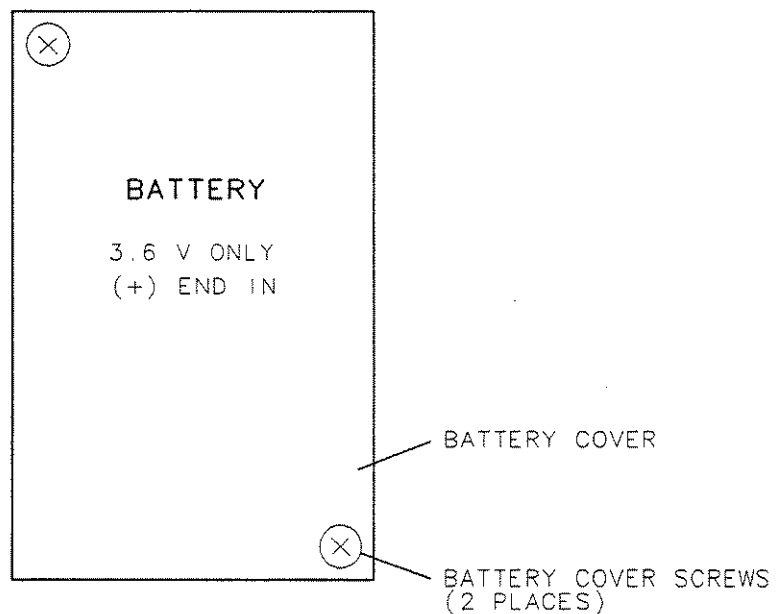

Figure 1-4. Replacing the Battery



## Front/Rear-Panel Features

The HP 70205A and HP 70206A display's front-panel and rear-panel features are described below.

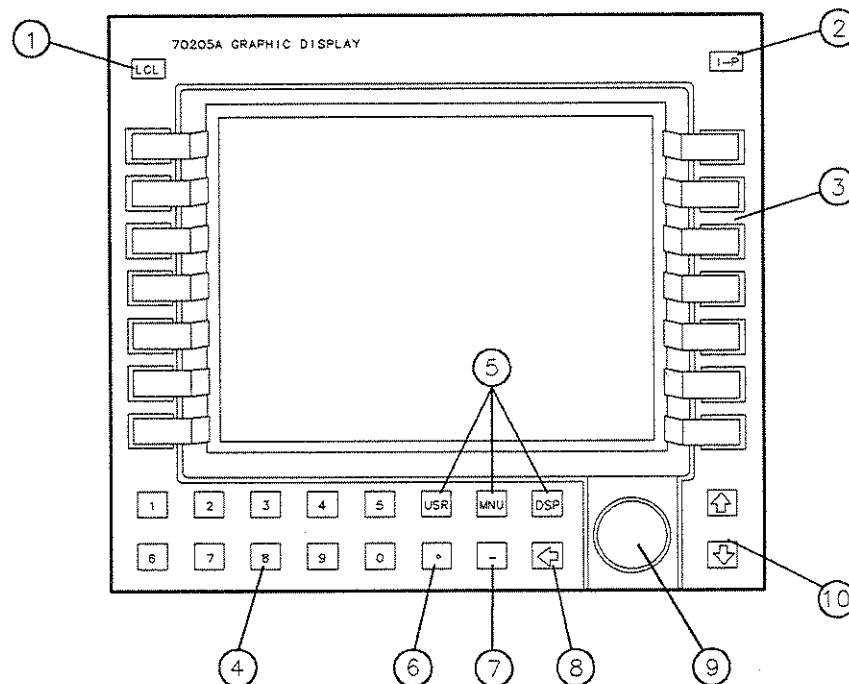

### HP 70205A Graphics Display Front-Panel Features

The HP 70205A front panel accesses all instrument functions using both fixed-label hardkeys and menu-driven softkeys. For the location of the front-panel features, see Figure 1-5.



**Figure 1-5. HP 70205A System Graphics Display Front-Panel Features**

1. **LCL** (local Control)—This hardkey returns the module to local control if it was in HP-IB remote.
2. **I/P** (Instrument Preset)—This key activates all the preset conditions of the display.
3. **Softkeys**—These keys allow access to the system functions.
4. **Numeric Keypad**—These keys are used for entering numeric values.
5. **USR**, **MNU**, **DSP**—These three hardkeys activate the top-level commands which appear on the screen next to the softkeys.
6. **Decimal Point**—This key enters a decimal point when using the numeric keyboard.
7. **Minus Sign**—This key enters negative numbers.
8. **←** (backspace)—Use this key to go from the lower level of softkeys to the next higher level.
9. **Display Knob**—Use this knob for changing parameter values, selecting alpha characters, and for accessing the diagnostic tests.

10.   (Step Keys)—These two keys change parameters up or down.

## HP 70205A Graphics Display Rear-Panel Features

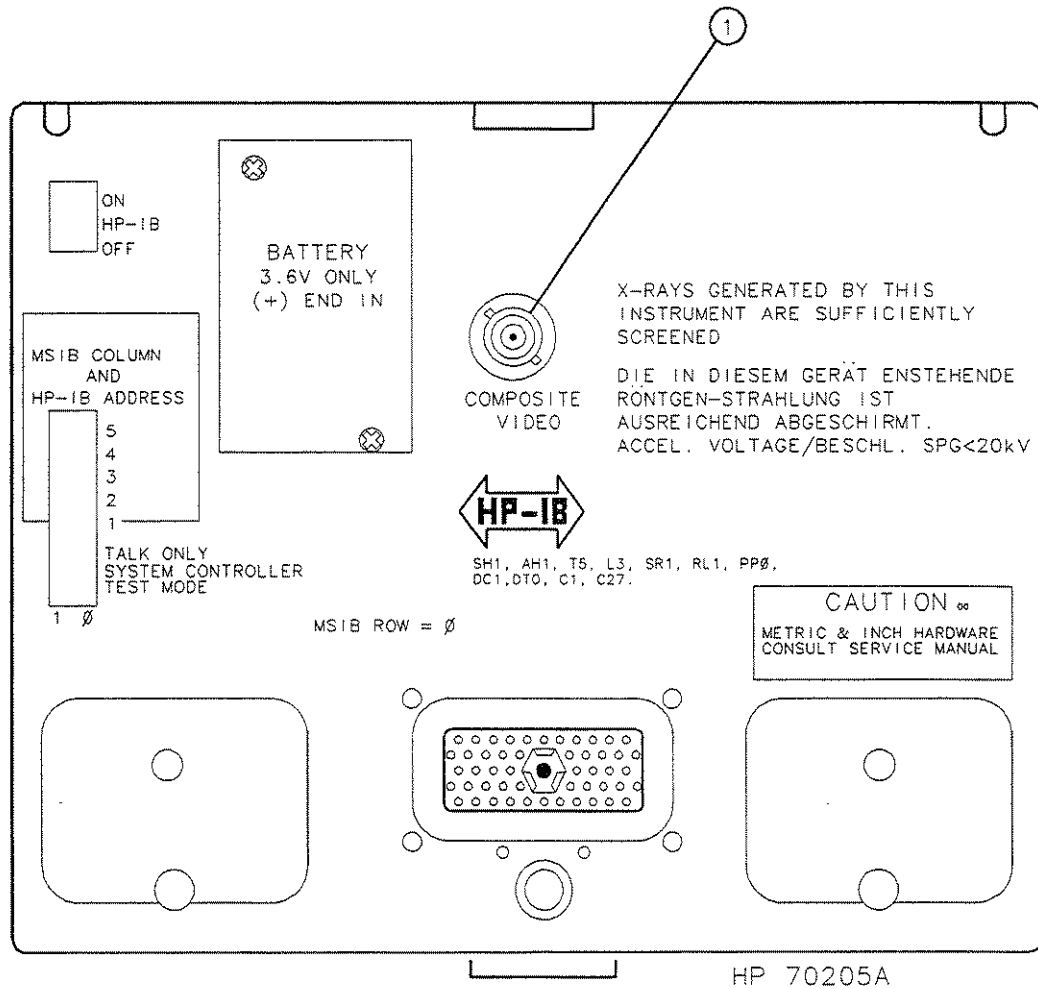

Figure 1-6. HP 70205A Graphics Display Rear-Panel Features

### Rear Panel Outputs

1. **Composite Video**—Video output for a 24 kHz compatible video monitor.

## HP 70206A System Graphics Display Front-Panel Features

The HP 70206A front panel accesses all instrument functions using both fixed-label hardkeys and menu-driven softkeys. For the location of the front-panel features, see Figure 1-7.

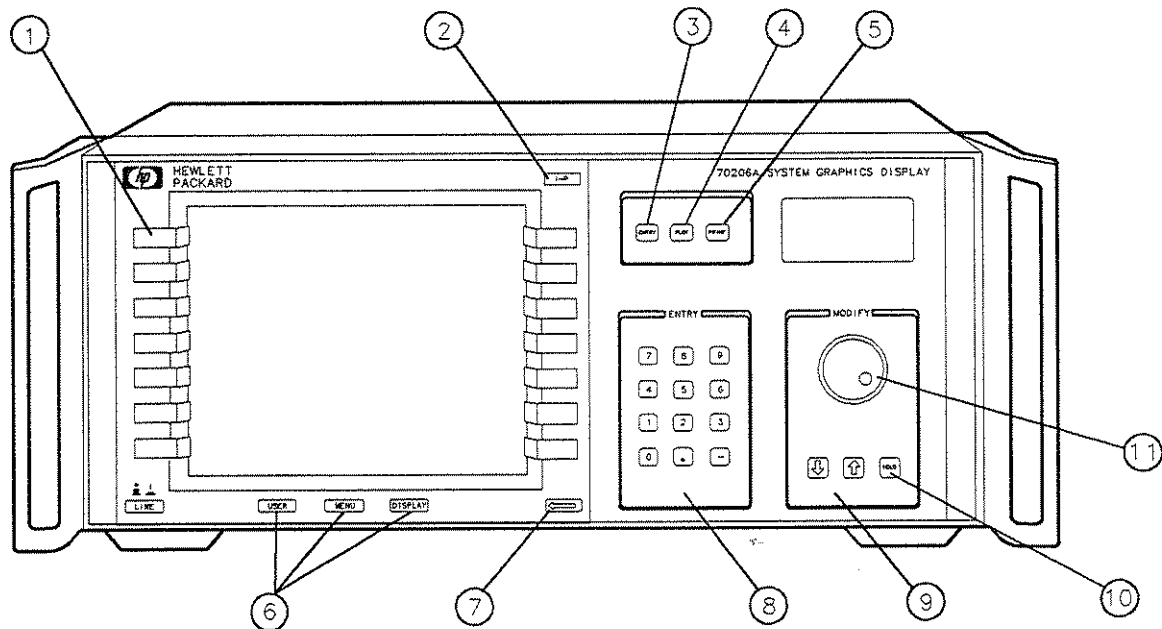

Figure 1-7. HP 70206A System Graphics Display Front-Panel Features

1. **Softkeys**—These keys allow access to the system functions.
2. **I/P** (Instrument Preset)—This key activates all the preset conditions of the display.
3. **LOCAL** (Local Control)—This hardkey returns the module to local control if it was in HP-IB remote.
4. **PLOT**—This key transfers information on the CRT to an X-Y Plotter.
5. **PRINT**—This key transfers information on the CRT to a graphics printer.
6. **USER**, **MENU**, and **DISPLAY**—These three hardkeys activate the top-level commands which then appear on the screen next to the softkeys.
7. **←** (backspace)—Use this key to go from a lower level of softkeys to the next higher level.
8. **Numeric Keypad**—Use these keys to enter numeric values.
9. **↑** **↓** (Step Keys)—These two keys change parameters up or down.
10. **HOLD**—This key deactivates the function displayed in the active function area.
11. **Display Knob**—Use this knob for changing parameter values, selecting alpha characters, and accessing the diagnostic tests.

## HP 70206A System Graphics Display Rear-Panel Features

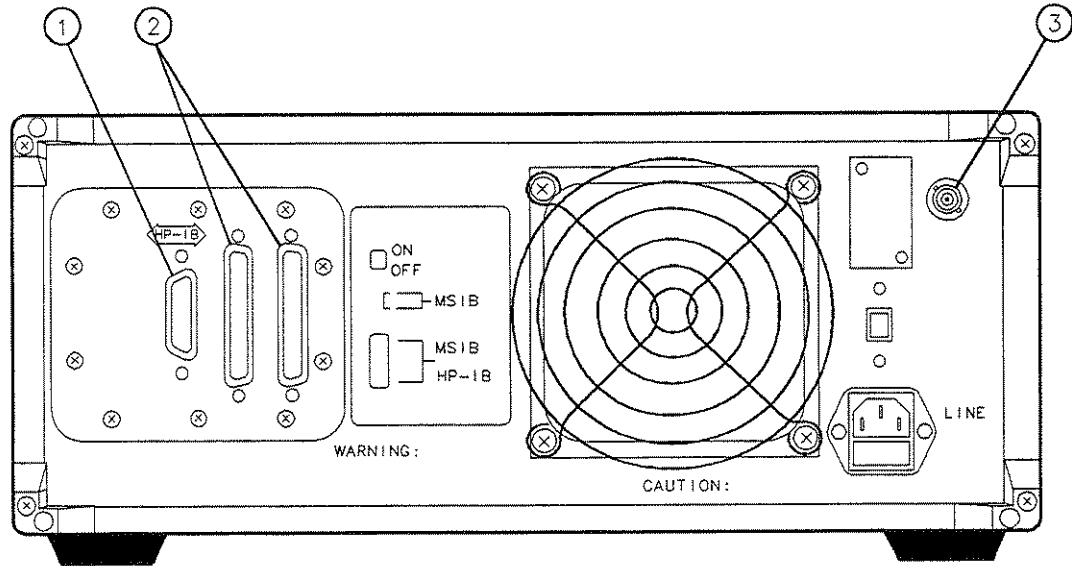

Figure 1-8. HP 70206A System Graphics Display Rear-Panel Features

### Rear Panel Inputs/Outputs

1. **HP-IB**—The Hewlett-Packard Interface Bus provides communication between controllers and other HP-IB instruments. The HP-IB fully complies with IEEE Standard 488.
2. **HP-MSIB**—The Hewlett-Packard Modular System Interface Bus is the HP 70000 system's own high-speed data bus. The display controls each instrument over HP-MSIB, while the individual instruments execute their own measurement procedures.
3. **Composite Video Output**—Video output for a 24 kHz (60 Hz vertical) compatible video monitor.

---

## Display Screen Cleaning

To avoid damaging the coating on the display CRT, use a thin-film cleaner such as Hewlett-Packard Display Cleaner (HP part number 8500-2163). The thin-film cleaner ought to be used with an abrasion-free cleaning tissue or soft cloth.

---

## Electrostatic Discharge Information

Electrostatic discharge (ESD) can damage or destroy electronic components. All work on electronic assemblies should be performed at a static-safe work station. Figure 1-9 shows an example of a static-safe work station using two types of ESD protection: (1) wrist-strap (with greater than 1 M $\Omega$  isolation to ground) and table-mat combination, (2) heel-strap (with greater than 1 M $\Omega$  isolation to ground) and conductive floor-mat combination. The two types must be used together to ensure adequate ESD protection. Isolation to ground must be provided for personnel protection. Refer to Table 1-4 for a list of static-safe accessories and their part numbers.

---

### Warning



In order to provide proper personnel protection, the wrist- and heel-straps must have greater than 1 M $\Omega$  isolation to ground.

---

## Hazards of Internal Repair and Adjustment

If you remove the HP 70205A and HP 70206A top cover for any reason, you must observe the following precautions.

---

### Warning



Disassembly, adjustments, and internal repairs should only be attempted by qualified technical personnel.

---

### Warning



The HP 70206A display's internal power supplies have lethal voltages, with lethal currents, in all areas.

**DANGEROUS VOLTAGES** exist on boards in this instrument even when the power is off.

AC power line voltage is present on the power supply board, even when the power switch is off.

Capacitors may retain high-voltage stored charges for several minutes, even with no power applied.

## Reducing ESD Damage

### Care and Handling of Electronic Components

- Handle these items at a static-safe work station.
- Store or transport these items in static-shielding containers.
- Use proper handling techniques.

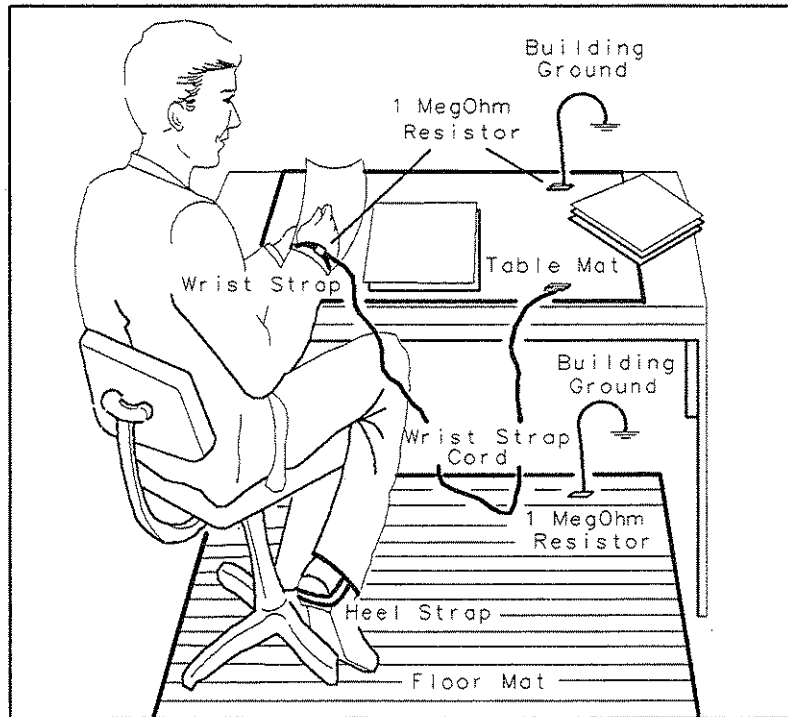

Figure 1-9. Example of a Static-Safe Work Station

## Static-Safe Accessories

**Table 1-4. Static-Safe Accessories**

HP Part Number	Description
9300-0797*	set includes: 3M static control mat 0.6 m × 1.2 m (2 ft × 4 ft) and 4.6 cm (15 ft) ground wire. (The wrist-strap and wrist-strap cord are not included. They must be ordered separately.)
9300-0980*	Wrist-strap cord 1.5 m (5 ft)
9300-1383*	Wrist-strap, color black, stainless steel, without cord, has four adjustable links and a 7 mm post-type connection.
9300-1169*	ESD heel-strap (reusable 6 to 12 months).
* Order through any Hewlett-Packard Sales and Service Office.	
92175A **	Black, hard-surface, static control mat, 1.2 m × 1.5 m (4 ft × 5 ft)
92175B **	Brown, soft-surface, static control mat, 2.4 m × 1.2 m (8 ft × 4 ft)
92175C **	Small, black, hard-surface, static control mat, 1.2 m × 0.9 m (4 ft × 3 ft)
92175T **	Tabletop static control mat, 58 cm × 76 cm (23 in × 30 in)
92176A **	Natural color antistatic carpet, 1.8 m × 1.2 m (6 ft × 4 ft)
92176C **	Russet color antistatic carpet, 1.8 m × 1.2 m (6 ft × 4 ft)
92176B **	Natural color antistatic carpet, 2.4 m × 1.2 m (8 ft × 4 ft)
92176D **	Russet color antistatic carpet, 2.4 m × 1.2 m (8 ft × 4 ft)
** Order by calling HP DIRECT Phone (800) 538-8787 or through any Hewlett-Packard Sales and Service Office.	

## Sales and Service Offices

Hewlett-Packard Sales and Service Offices provide complete support for Hewlett-Packard products. To obtain servicing information, or to order replacement parts, contact the nearest Hewlett-Packard Sales and Service Office listed in Table 1-5. In any correspondence, be sure to include the pertinent information about model numbers, serial numbers, or assembly part numbers.

**Table 1-5. Hewlett-Packard Sales and Service Offices**

<b>IN THE UNITED STATES</b>	<b>IN AUSTRALIA</b>	<b>IN JAPAN</b>
<b>California</b>	Hewlett-Packard Australia Ltd.	Yokogawa-Hewlett-Packard Ltd.
Hewlett-Packard Co.	31-41 Joseph Street	29-21 Takaido-Higashi, 3 Chome
1421 South Manhattan Ave.	Blackburn, Victoria 3130	Suginami-ku Tokyo 168
P.O. Box 4230	895-2895	(03) 331-6111
Fullerton, CA 92631		
(714) 999-6700	<b>IN CANADA</b>	<b>IN PEOPLE'S REPUBLIC</b>
	Hewlett-Packard (Canada) Ltd.	<b>OF CHINA</b>
Hewlett-Packard Co.	17500 South Service Road	China Hewlett-Packard, Ltd.
301 E. Evelyn	Trans-Canada Highway	P.O. Box 9610, Beijing
Mountain View, CA 94039	Kirkland, Quebec H9J 2X8	4th Floor, 2nd Watch Factory
(415) 694-2000	(514) 697-4232	Main Bldg.
		Shuang Yu Shu, Bei San Huan Rd.
<b>Colorado</b>	<b>IN FRANCE</b>	Beijing, PRC
Hewlett-Packard Co.	Hewlett-Packard France	256-6888
24 Inverness Place, East	F-91947 Les Ulis Cedex	
Englewood, CO 80112	Orsay	
(303) 649-5000	(6) 907-78-25	
		<b>IN SINGAPORE</b>
<b>Georgia</b>	<b>IN GERMAN FEDERAL</b>	Hewlett-Packard Singapore
Hewlett-Packard Co.	<b>REPUBLIC</b>	Pte. Ltd.
2000 South Park Place	Hewlett-Packard GmbH	1150 Depot Road
P.O. Box 105005	Vertriebszentrale Frankfurt	Singapore 0410
Atlanta, GA 30339	Berner Strasse 117	273 7388
(404) 955-1500	Postfach 560 140	Telex HPSGSO RS34209
	D-6000 Frankfurt 56	Fax (65) 2788990
	(0611) 50-04-1	
<b>Illinois</b>	<b>IN GREAT BRITAIN</b>	<b>IN TAIWAN</b>
Hewlett-Packard Co.	Hewlett-Packard Ltd.	Hewlett-Packard Taiwan
5201 Tollview Drive	King Street Lane	8th Floor, Hewlett-Packard
Rolling Meadows, IL 60008	Winnersh, Wokingham	Building
(312) 255-9800	Berkshire RG11 5AR	337 Fu Hsing North Road
	0734 784774	Taipei
<b>New Jersey</b>		(02) 712-0404
Hewlett-Packard Co.	<b>IN OTHER EUROPEAN</b>	<b>IN ALL OTHER LOCATIONS</b>
120 W. Century Road	<b>COUNTRIES</b>	Hewlett-Packard Inter-Americas
Paramus, NJ 07653	Hewlett-Packard (Schweiz) AG	3495 Deer Creek Rd.
(201) 265-5000	Allmend 2	Palo Alto, California 94304
	CH-8967 Widen (Zurich)	
<b>Texas</b>	(0041) 57 31 21 11	
Hewlett-Packard Co.		
930 E. Campbell Rd.		
Richardson, TX 75081		
(214) 231-6101		



---

## Returning Instruments for Service

If you are returning the display to Hewlett-Packard for servicing, fill in and attach a blue service tag. Blue service tags are supplied at the end of this chapter. Please be as specific as possible about the nature of the problem. Include copies of error messages, data related to display performance, type of system, and so forth, along with the display being returned.

### Packaging

The original shipping containers should be used. If the original materials were not retained, identical packaging materials are available through any Hewlett-Packard office. Figures 1-10 and 1-11 are illustrations of the factory packaging material for the two displays.

---

#### Caution



Instrument damage can result from using packaging materials other than those specified. Never use styrene pellets as packaging material. They do not adequately cushion the instrument or prevent it from shifting in the carton. They also cause instrument damage by generating static electricity.

---

#### Instrument Shipping Preparation Procedure.

1. Fill out a blue repair card (located at the end of this chapter) and attach it to the instrument. Include any error messages or specific performance data related to the problem. If a blue repair tag is not available, the following information should be noted and sent with the instrument.
  - a. Type of service required.
  - b. Description of the problem.
  - c. Is problem constant or intermittent.
  - d. Name and phone number of technical contact person.
  - e. Return address.
  - f. Model number of returned instrument.
  - g. Full serial number of returned instrument.
  - h. List of any accessories returned with instrument.
2. Pack the instrument in the appropriate packaging materials. (See Figures 1-10 and 1-11.) Original shipping materials or the equivalent should be used. If the original or equivalent materials cannot be obtained, instruments can be packaged for shipment using the following instructions.

---

#### Caution



Inappropriate packaging of instruments may result in damage to the instrument during transit.

---

- a. Wrap the instrument in anti-static plastic to reduce the possibility of damage caused by ESD.
- b. For instruments that weigh less than 54 kg (120 lb), use a double-walled, corrugated cardboard carton of 159 kg (350 lb) test strength.
- c. The carton must be large enough to allow 3 to 4 inches on all sides of the instrument for packing material and strong enough to accommodate the weight of the instrument.
- d. Surround the equipment with three to four inches of packing material, to protect the instrument and prevent it from moving in the carton.

- e. If packing foam is not available, the best alternative is S.D.-240 Air Cap from Sealed Air Corporation (Commerce, California 90001). Air Cap looks like a plastic sheet filled with 1-1/4 inch air bubbles.
  - f. Use the pink (anti static) Air Cap to reduce static electricity. Wrapping the instrument several times in this material will protect the instrument and prevent it from moving in the carton.
3. Seal the carton with strong nylon adhesive tape.
  4. Mark the carton 'FRAGILE, HANDLE WITH CARE'.
  5. Retain copies of all shipping papers.

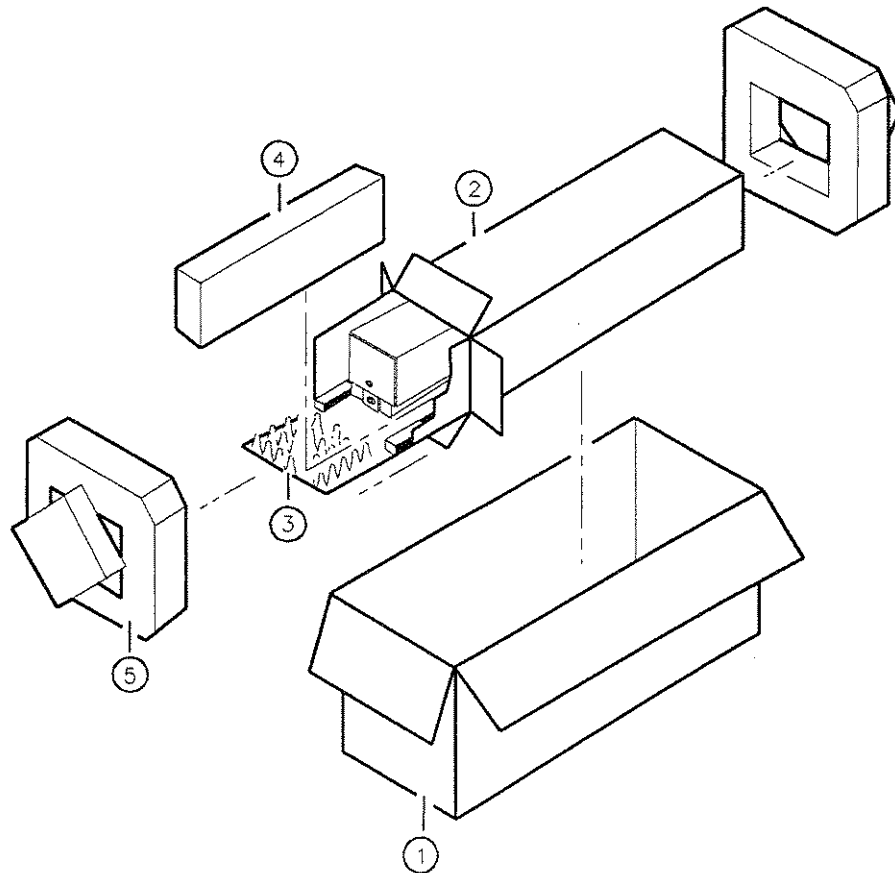

Figure 1-10. Packaging Material for the HP 70205A

Item	HP Part Number	CD	Qty	Description
1	9211-5118	9	1	Carton-Outer
2	9211-5119	0	1	Carton-Inner
3	5180-2369	5	1	Foam-slider
4	4208-0493	1	2	Foam Insert
5	5180-2370	8	1	Foam Pads

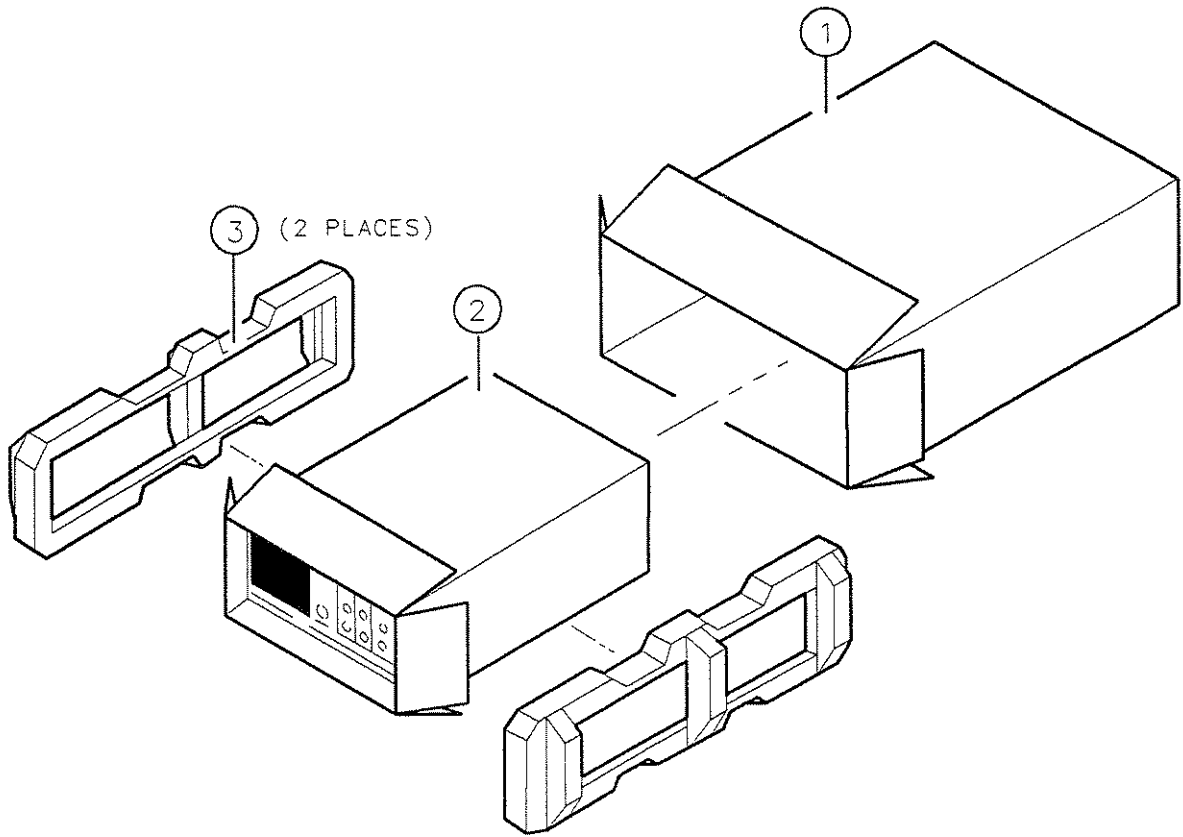

Figure 1-11. Packaging Material for the HP 70206A

Item	HP Part Number	CD	Qty	Description
1	9211-4487	3	1	Carton-Outer
2	5180-2321	9	1	Carton-Inner
3	5180-7829	5	2	Foam Pads



## Installation

---

### Introduction

This chapter contains information needed to install both the HP 70205A Graphic Display into an HP 70000 Series mainframe, and to connect an HP 70206A System Graphics Display into a system. Refer to the following two sections of this chapter for more information about installing and configuring your display.

- Installation of the HP 70205A Graphics Display Module.
- Installation of the HP 70206A System Graphics Display.

---

#### Note



Addressing and cabling examples in this chapter are general in nature. For more detailed information about HP 70000 Modular Measurement System configuration, cabling, and HP-MSIB (Hewlett-Packard Modular System Interface Bus) addressing, refer to the Installation and Verification Manual for your instrument.

---

## Installation of the HP 70205A Graphics Display Module.

Installation of the HP 70205A Graphics Display module into an HP 70000 Modular Measurement System requires the following steps:

1. Addressing the display module.
2. Installing the display module in a mainframe.

When properly installed, the HP 70205A gets both power and interface-bus control through the module rear-panel mainframe/module interconnect. After installing the module, refer to Chapter 4 to ensure that the module is operational.

### Addressing the HP 70205A Graphics Display

The HP 70205A needs an appropriate HP-MSIB address to allow communications with the system master. Use the display's COLUMN address switch to set the HP-MSIB address. The ROW address is always 0.

#### Determining the HP-MSIB Address

The HP 70205A has a factory-preset HP-MSIB column address of 4. Figure 2-1 shows the address map for an HP 70206A Graphics Display module whose address is set to 4. The addresses in this figure are factory-preset for the display.

To access the address map:

1. Press the **(DSP)** hardkey.
2. Press the **address map** softkey.

Refer to the *HP 70205A and HP 70206A Operation Manual* for more information about setting up the address map.

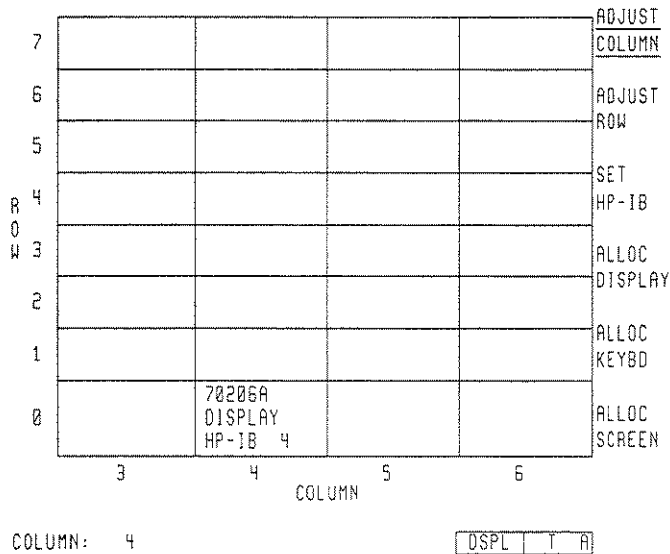

Figure 2-1. HP 70205A Graphics Display Address Map

The HP 70001A mainframe does not have an HP-MSIB address.

---

**Note**

When used with other factory-preset modules, you do not have to change the display's preset addressing.

---

## Setting the HP-MSIB Address Switches

To establish proper system function and HP-MSIB communication, each element has an address switch that is preset to a binary, 8-bit HP-MSIB address. Each element in a system must be assigned a unique address. Use the five rear-panel COLUMN switches to set the display's column address. This manual refers to the decimal equivalents of the binary column addresses.

**Table 2-1. Decimal Equivalents of Binary Addresses**

	Column
Binary	00100
Decimal	04

A module-address change requires the following two steps:

1. Locate the address switches on the rear panel of the module. See Figure 2-2 for an example of the switches.
2. Set the five COLUMN switches to the binary value of the module's HP-MSIB column number.

---

**Note**

Changing HP-MSIB addresses requires an understanding of HP-MSIB addressing rules. If you use a custom addressing configuration, refer to the Installation and Verification Manual for your instrument (for example, HP 70900B Local Oscillator) for information about assigning HP-MSIB addresses.

---

## Setting the HP-IB Switch

When you set the HP-IB switch to 0 (OFF), the display disables the HP-IB. When switched, the HP-IB switch does not disrupt HP-MSIB instrument operation. Refer to Figure 2-2 for the location of the HP-IB switch.

## Display Address Switches

A graphics display is an independent element. You may assign the display both HP-MSIB and HP-IB addresses. Figure 2-2 illustrates the display's address switches. The address switches are a group of two position toggle switches, which you can set to either 1 or 0.

### HP-IB ON/OFF

The HP-IB ON/OFF switch switches the display on or off the HP-IB without disrupting instrument HP-MSIB operation.

A6—A8

The graphical representation of these switches indicates that the display's HP-MSIB row address is always 0.

A1—A5

These address switches set the HP-MSIB column address, which is also the default HP-IB address. Setting the HP-IB address from the front panel overrides the rear-panel HP-IB address switch setting.

TALK ONLY

When you set the Talk Only switch to 1 (ON), the display can talk on HP-IB without requiring a reply. This accommodates, for example, listen-only plotters. For normal operation, set this switch to 0 (OFF).

SYSTEM CONTROLLER

When you set the System Controller switch to 1 (ON) the display functions as a system (bus) controller on HP-IB during printer and plotter outputs.

TEST MODE

When you set the Test Mode switch to 1 (ON), the display goes into a special test mode at power-up. For normal operations, set this switch to 0 (OFF).

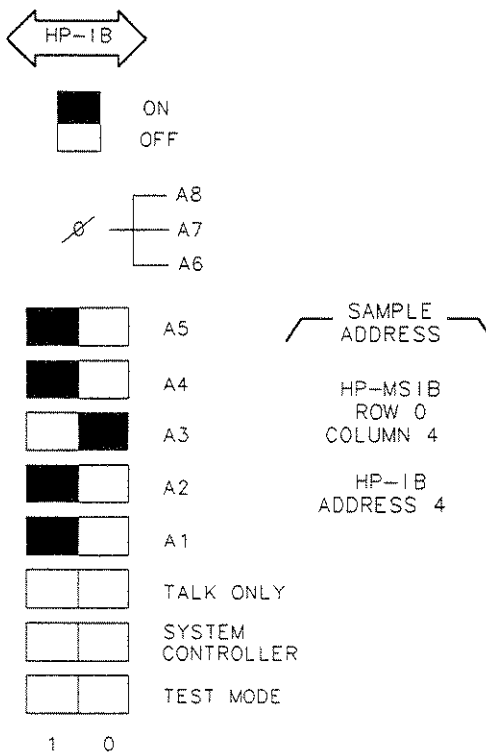

Figure 2-2. Module Address Switches



## Installing the HP 70205A in the Mainframe

To install the HP 70205A in an HP 70000 Series mainframe, follow the procedure below. Figure 2-3 identifies the module and mainframe parts called out in the procedure.

### Caution



To avoid blowing the mainframe line fuse, internal module fuses, or possibly damaging the 50-pin module connector turn the mainframe power *off* before connecting or disconnecting any modules.

### Module Installation

1. Turn the mainframe LINE switch OFF.
2. Open the mainframe front-panel door.
3. Slide the module into the mainframe.
4. Tighten the module latch, using an 8 mm hex-ball driver while pressing against the module front.
5. Close the mainframe front-panel door.
6. Turn the mainframe LINE switch ON.

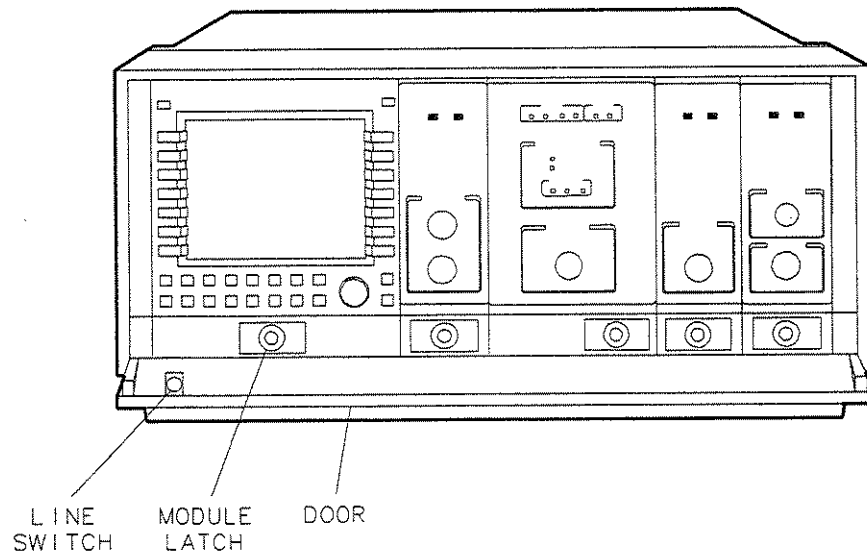

Figure 2-3. Module Installation

---

## Installation of the HP 70206A System Graphics Display

Installation of the display into an HP 70000 Modular Measurement System requires the following steps:

1. Setting the line voltage selector.
2. Addressing the display.
3. Connecting the display to a mainframe.

### Line Voltage Selector

Set the line-voltage selector to the setting that corresponds to the power source used. The voltage selector switch is located on the rear panel, just above the ac power cord receptacle housing. Refer to Figure 2-4 for an illustration of the line-voltage selector.

---

#### Warning



Before turning this instrument on, be sure it is grounded through the protective conductor of the ac power cable to a socket outlet provided with protective earth contact. Any interruption of the protective (grounding) conductor inside or outside the instrument, or disconnection of the protective earth terminal, can result in personal injury.

---

#### Caution



Before turning this instrument on, make sure the line voltage selector is set to the voltage of the ac power source:

- 115 V position for 90 to 132 V ac line input voltages.
- 230 V position for 198 to 264 V ac line input voltages.

Failure to set the ac power input to the correct voltage could cause one of two things to happen when power is applied:

- If the switch is set to 115 V and the instrument is connected to 230 V, the fuse will blow.
- If the switch is set to 230 V and the instrument is connected to 115 V, the instrument will not turn on and the VOLT/TEMP fault indicator will light.

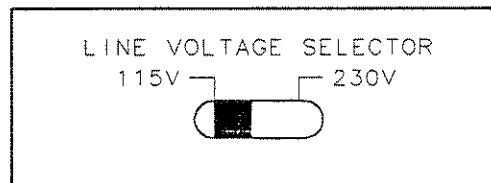

Figure 2-4. Line Voltage Selector (Shown in 115 V Position)

## Fuse Replacement

You can locate the line fuse inside the power-cord receptacle housing on the back of the instrument. Also included in this housing is a spare fuse. The fuse is a 5 by 20 mm fuse rated at 6.3 A, 250 V, HP part number 2110-0703. Refer to Figure 2-5 for fuse removal and replacement.

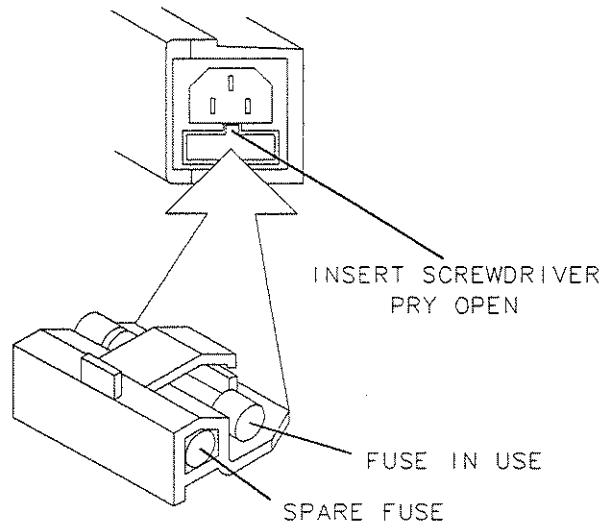

Figure 2-5. Fuse Removal and Replacement

## Addressing the HP 70206A System Graphics Display

The HP 70206A needs an appropriate HP-MSIB address to allow communication with the system master. Use the display's address switch to set the display's HP-MSIB and HP-IB addresses.

### Determining the HP-MSIB Address

The HP 70206A has a factory-preset HP-MSIB column address of 4. Figure 2-6 shows the address map for an HP 70206A System Graphics Display. The addresses in this figure are factory-preset for the display.

To access the address map:

1. Press the **DISPLAY** hardkey.
2. Press the **address map** softkey.

Refer to *HP 70205A and HP 70206A Operation Manual* for more information about using the address map.

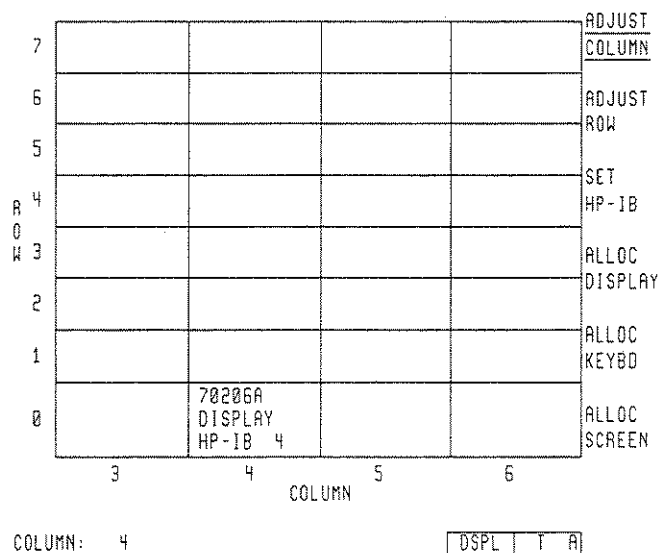

**Figure 2-6. HP 70206A System Graphics Display Address Map**

The HP 70001A mainframe does not have an HP-MSIB address.

**Note** When used with other factory-preset modules, you do not have to change the preset addressing.



**Setting the HP-MSIB Address Switches**

To establish proper system function and HP-MSIB communication, each element has an address switch that is preset to a binary, 8-bit HP-MSIB address. Each element in a system must be assigned a unique address. Use the five rear-panel COLUMN switches to set the display's column address. The manual refers to the decimal equivalents of the binary row and column addresses.

**Table 2-2. Decimal Equivalents of Binary Addresses**

	Column
<b>Binary</b>	00100
<b>Decimal</b>	04

A module-address change requires the following steps:

1. Locate the address switches on the rear panel of the display. See Figure 2-7 for an example of the switches.
2. The ROW address switches are permanently set to row 0.
3. Set the five COLUMN switches to the binary value of the module's HP-MSIB column number.

---

**Note**

Changing HP-MSIB addresses requires an understanding of HP-MSIB addressing rules. If you use a custom addressing configuration, refer to the installation and verification manual for your instrument (for example, HP 70900A Local Oscillator) for information about assigning HP-MSIB addresses.

---

### Setting the HP-IB Switch

When you set the HP-IB switch to 0 (OFF), the display switches off the HP-IB. The HP-IB switch does not disrupt instrument operation. Refer to Figure 2-7 for the location of the HP-IB switch.

### Display Address Switches

A graphics display is an independent element. You may assign the display both HP-MSIB and HP-IB addresses. Figure 2-7 illustrates the display's address switches. The address switches are a group of two position toggle switches, which can be set to either 1 or 0.

HP-IB ON/OFF

The HP-IB ON/OFF switch switches the display on or off the HP-IB without disrupting instrument operation.

A6—A8

The graphical representation of these switches indicates that the display's HP-MSIB row address is always 0.

A1—A5

These address switches set the HP-MSIB column address, which is also the default HP-IB address. Setting the HP-IB address from the front panel overrides the rear-panel HP-IB address switch setting.

TALK ONLY

When you set the Talk Only switch to 1 (ON), the display can talk on HP-IB without requiring a reply. This accommodates, for example, listen-only plotters. For normal operation, set switch to 0 (OFF).

SYSTEM CONTROLLER

When you set the System Controller switch to 1 (ON) the display functions as a system controller on HP-IB during printer and plotter outputs.

TEST MODE

When you set the Test Mode switch to 1 (ON), the display goes into a special test mode at power-up. For normal operation, set this to 0 (OFF).

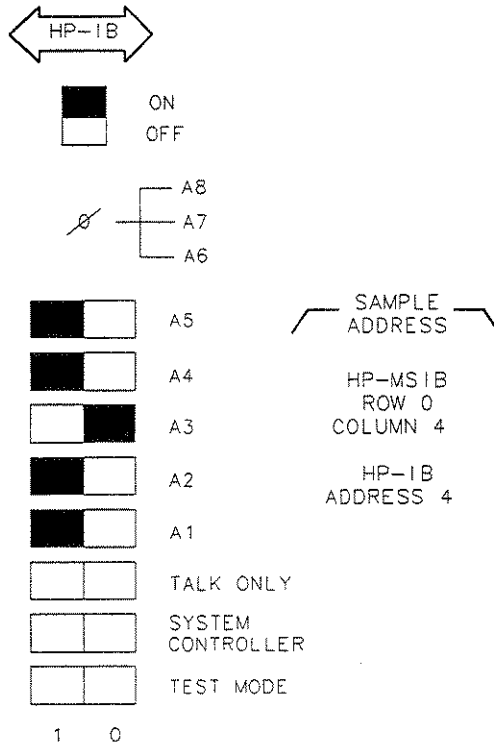
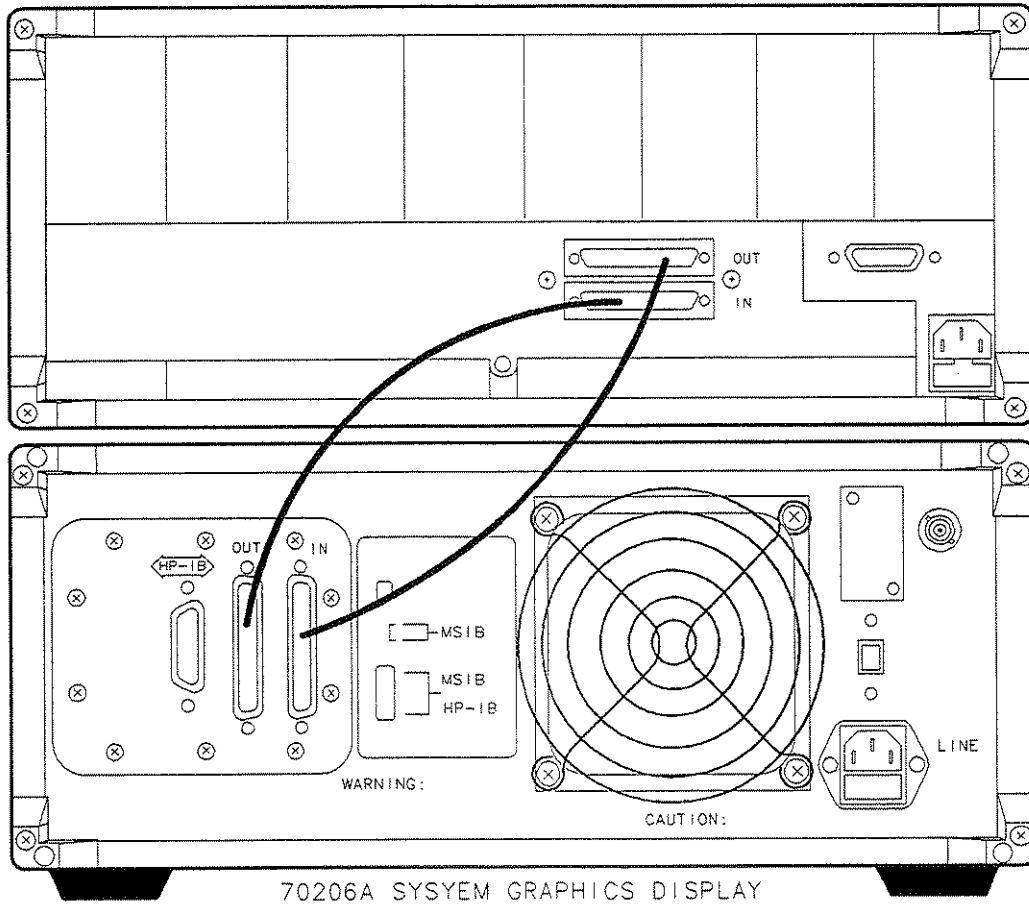

**Figure 2-7. Display Address Switches**

### Connecting the Display to a Mainframe

Connect the HP-MSIB cables serially, coupling the input of one element to the output of next until the loop is completed. Figure 2-8 shows an example of display-to-mainframe cabling. The same example applies to other products supporting HP-MSIB.

70001A MAINFRAME



NOTE: ALWAYS CONNECT AN OUTPUT TO AN INPUT

**Figure 2-8. HP-MSIB Cabling Example**

### Remote Operation

The use of long HP-MSIB cables to separate the display and mainframe (or other products supporting HP-MSIB) allows remote operation. Since the signals on the HP-MSIB are digital, only measurement speed is slightly degraded.

---

## 400 Hz Option

The HP 70206A System Graphics Display is available with a 400 Hz option that allows the display to operate on a 400 Hz power-line frequency. The 400 Hz option requires an external in-line 600 VA isolation transformer (included with the option) when the instrument uses a 400 Hz power source.

---

### Warning



Never operate a 400 Hz option instrument on a 400 Hz power line without using the in-line isolation transformer supplied for this purpose. Failure to follow this precaution can create a shock hazard which may result in personal injury.

---

---

### Caution



Remove the in-line isolation transformer when using 50/60 Hz power source operation. Failure to remove the in-line 400 Hz transformer will destroy the 400 Hz transformer input fuse. When the isolation transformer is removed, a standard power cord must be used. The in-line transformer must be reinstalled when using a 400 Hz power source, in order to protect the user from electric shock hazard.

---

---

## Intensity Adjustments

**INTEN ADJUST** allows the user to change the brightness of the picture on the screen. Brightness is incrementally adjustable from 0 to 19 in steps of 1.

---

### Note



The 0 intensity setting may not be completely off.

---



## Specifications

---

### Introduction

The following specifications apply to the HP 70205A and HP 70206A graphics displays. Refer to the appropriate section of this chapter for specifications for either the HP 70205A or HP 70206A.

---

### Specifications

Specifications describe warranted performance over the temperature range 0°C to 55°C (except where noted) after 1 hour of continuous operation.

---

### Nominal Values

Nominal values provide useful information by giving functional, but nonwarranted, performance parameters.

---

# HP 70205A Graphics Display Specifications

## General

Temperature <sup>1</sup>	Operation .....0°C to +55°C Storage ..... -40°C to +75°C
EMI	Radiated interference is within the requirements of MIL-STD 461B, Class A1c RE02
Weight (nominal value)	5.1 kg (11.2 lb)
Dimensions (nominal value)	3/8-width module
<sup>1</sup> The power and cooling requirements for the HP 70205A module are provided by the HP 70001A Mainframe.	

## Rear-Panel Output

**Composite Video** (characteristic)  
BNC, female connector

Horizontal Frequency .....24 kHz  $\pm$ 1%  
Signal Level (75 $\Omega$ ) ..... 1 V p-p  $\pm$ 10%  
Vertical Frequency .....60 Hz  $\pm$ 1%  
Bandwidth .....25 MHz

# HP 70206A System Graphics Display Specifications

## General

<b>Temperature</b>	Operation .....	0°C to +55°C
	Storage .....	-40°C to +75°C
<b>EMI</b>	Radiated interference is within the requirements of MIL-STD 461B, Class A1c RE02	
<b>Weight (nominal value)</b>	18.6 kg (41 lb)	
<b>Dimensions (nominal value)</b>	Height .....	177 mm (6.97 in)
	Width .....	425 mm (16.75 in)
	Length .....	502.0 mm (19.75 in)
<b>AC Power Input Line Ranges</b>	90—132 V ac .....	47—66 Hz
	198—264 V ac .....	47—66 Hz
	103—132 V ac ..	365—444 Hz (with Option 400)
<b>VA Rating</b>	310 W maximum	
	570 VA maximum	

## Rear-Panel Output

**Composite Video (characteristic)**  
BNC, female connector

Horizontal Frequency ..... 24 kHz  $\pm$ 1%  
Signal Level (75 $\Omega$ ) ..... 1 V p-p  $\pm$ 10%  
Vertical Frequency ..... 60 Hz  $\pm$ 1%  
Bandwidth ..... 25 MHz



## Verification

---

### Introduction

This chapter normally contains performance verification tests, which evaluate the electrical performance of the unit against its specifications. There are no performance verification tests that apply to the HP 70205A or HP 70206A graphics display specifications.

---

### Power-On Self-Test

The display executes a power-on self-test when power is applied. If the test fails, the sequence is terminated and an error is displayed on the screen in large block letters.

One of the instrument functions tested is the ability of the display to communicate on the system bus (HP-MSIB). The results of the test can be determined by examining the status box in the lower right-hand corner of the display screen. If the power-on tests fails, a blinking E will appear in the status box.

If either error is indicated (large block letters or blinking E), refer to Chapter 5, "Troubleshooting."

---

### Confidence Test (~~CONFID TEST~~ Softkey)

The Display Confidence Test checks the operation of about 90% of the display. For more information about the Confidence Test refer to Chapter 5, "Troubleshooting."

---

### HP 70206A System Graphics Display Fault Indicator

The HP 70206A Display has a back-lit I/O fault indicator in the upper-right corner of front panel.

- The I/O indicator should be ON, then OFF within 5 seconds.

If a fault is indicated, the condition must be cleared before the display will operate. Refer to Chapter 5, "Troubleshooting."



## Troubleshooting

---

### Introduction

This chapter provides troubleshooting information on the HP 70205A and HP 70206A graphics displays. Problem isolation and diagnosis related to the front-panel fault indicator lights, fan operation, fuse replacement, Key Test, and Confidence Test are discussed. The location and identification of the front-panel fault indicators are shown in Figures 5-1 and 5-2.

---

### Turn-On

#### HP 70205A Graphics Display

If after turn-on an error is detected, run the Confidence Test. Refer to “Confidence Test” in this chapter. If the Confidence Test runs successfully, the first error was probably a system failure, not a display failure.

#### HP 70206A System Graphics Display

If after turn-on an error is detected, run the Confidence Test. Refer to “Confidence Test” in this chapter. If the Confidence Test runs successfully, the first error was probably a system failure, not a display failure. The following conditions should exist at display turn-on:

- The I/O fault indicator should blink on and then turn off.
- The fan noise will be noticeable.

---

#### Note



Some older models may have a second fault-indicator labeled AIRFLOW. This indicator should not light. The circuitry for this function should be disabled.

---

---

## HP 70206A Line Fuse

A 6.3 A, 250 V line fuse is located inside the power receptacle on the back of the display. The most common reason for an open fuse is improper setting of the line voltage selector; however, internal problems can also cause a fuse to open. See Figure 2-5 for fuse removal and replacement information.

---

## Fault Indicators

### HP 70205A Fault Indicator

The HP 70205A has one fault indicator, a blinking E in the status box in the lower-right corner of the display. See Figure 5-1. Problems external to the display can cause the indicator to turn on.

#### Blinking E

The E indicator in the status box in the lower-right corner of the display is the same as the red LED marked ERR on other HP 70000 Series modules. Its purpose is to indicate an error detected in the module or, in the case of the display, in *any* module (on HP-MSIB row 0) in the system. A blinking E or ERR has a special meaning: it signifies that a problem on the HP-MSIB backplane has been detected during system power-up which may prevent normal communication (and hence, normal error reporting). Such a problem *must* be troubleshot before any predictable system operation can take place.

Remove all other modules from the mainframe containing the HP 70205A display. Disconnect all HP-MSIB cables from the rear of the mainframe and cycle power. If the E indicator on the display screen still blinks, there is an HP-MSIB problem in the display or in the mainframe. Obtain another HP 70000 module of any kind. Remove the HP 70205A display from the mainframe and put the other module in the same slot. Apply power. If the ERR indicator on the module blinks, most likely the problem is in the mainframe. Refer to the *HP 70001A Mainframe Installation and Verification Manual* for more information about troubleshooting the mainframe. If the second module powers up normally, most likely the problem is in the display. Contact the nearest Hewlett-Packard Service Office listed in Table 1-5.



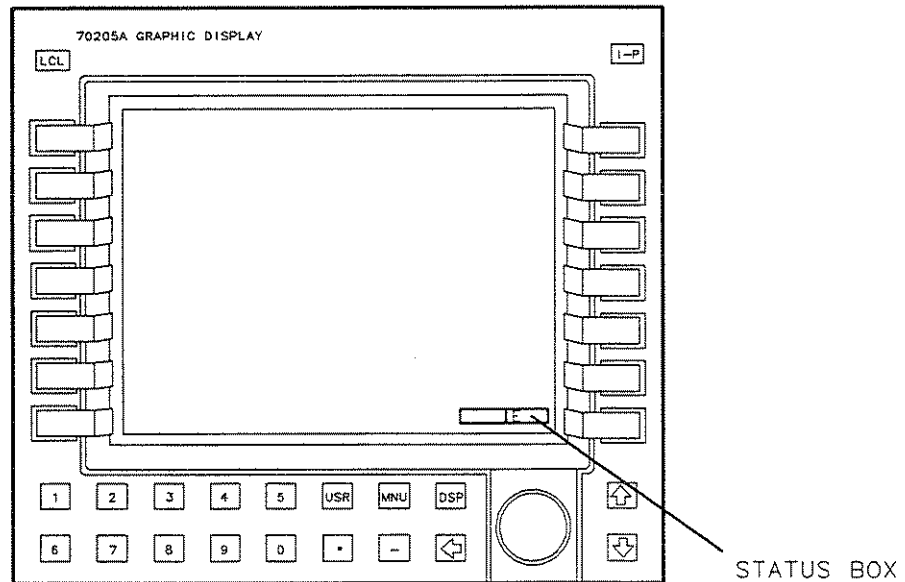

**Figure 5-1. HP 70205A Front-Panel Fault Indicators**

### **HP 70206A Fault Indicators**

The HP 70206A has two fault indicators: a blinking E in the status box in the lower-right corner of the display and an I/O indicator on the upper-right corner of the front panel. See Figure 5-2. Problems external to the display can cause the indicators to turn on.

#### **Blinking E**

The E indicator in the status box in the lower-right corner of the display is the same as the red LED marked ERR on other HP 70000 Series modules. Its purpose is to indicate an error detected in the module or, in the case of the display, in *any* module (on HP-MSIB row 0) in the system. A blinking E or ERR has a special meaning: it signifies that a problem on the HP-MSIB backplane has been detected during system power-up which may prevent normal communication (and hence, normal error reporting). Such a problem *must* be troubleshot before any predictable system operation can take place.

Remove all HP-MSIB cables from its rear panel and cycle power. If the E indicator on the display still blinks, then contact the nearest Hewlett-Packard Service Office listed in Table 1-5, for repair. If the E indicator does not light, then connect a known good HP-MSIB cable between the rear-panel HP-MSIB IN and OUT connectors, and cycle power. If the E now blinks, contact your nearest Hewlett-Packard Service Office for repair. If the E indicator now blinks, refer to the mainframe's Installation and Verification Manual for more information about troubleshooting the mainframe.

## I/O Indicator Light

This circuitry senses the readiness of the external HP-MSIB. If the indicator is on, HP-MSIB communications are inhibited. The I/O fault indicator light will be on if one of the following conditions is true.

- The external HP-MSIB loop is not complete. Check that both ends of all HP-MSIB cables are securely connected.<sup>1</sup>
- Not all the elements on the external HP-MSIB loop have the power turned on. Verify that the power to the display, and to all mainframes and stand-alone instruments on the external HP-MSIB, is on.

HP-MSIB communication will resume as soon as the problem is corrected.

If an I/O light fault is indicated, the following steps will help isolate the problem.

Disconnect both HP-MSIB cables from the display rear panel. Is the I/O fault indicator still on?

**NO** The problem is either with the cables, or an element that was connected to the display with the cables.

Loop each cable (one at a time) from the display "IN" to "OUT" HP-MSIB connectors. If the I/O light comes on, that cable is faulty. If the light does not come on for any of the cables, then an element connected with these cables is faulty. If an element is determined to be at fault, contact your nearest Hewlett-Packard Service Office for repair.

**YES** The HP 70206A display is probably faulty. Refer to "Using the HP-MSIB Troubleshooting Utility" in this chapter for more information about troubleshooting the HP-MSIB.

---

<sup>1</sup> If more than one mainframe is used, or if other elements are connected to the HP-MSIB, all cables must be connected; otherwise, the HP-MSIB will not operate. If a single mainframe with no external elements is used, there should be no HP-MSIB cables connected to the external HP-MSIB connectors of that mainframe, although a single cable looped from the input connector to the output connector will allow the mainframe to operate.

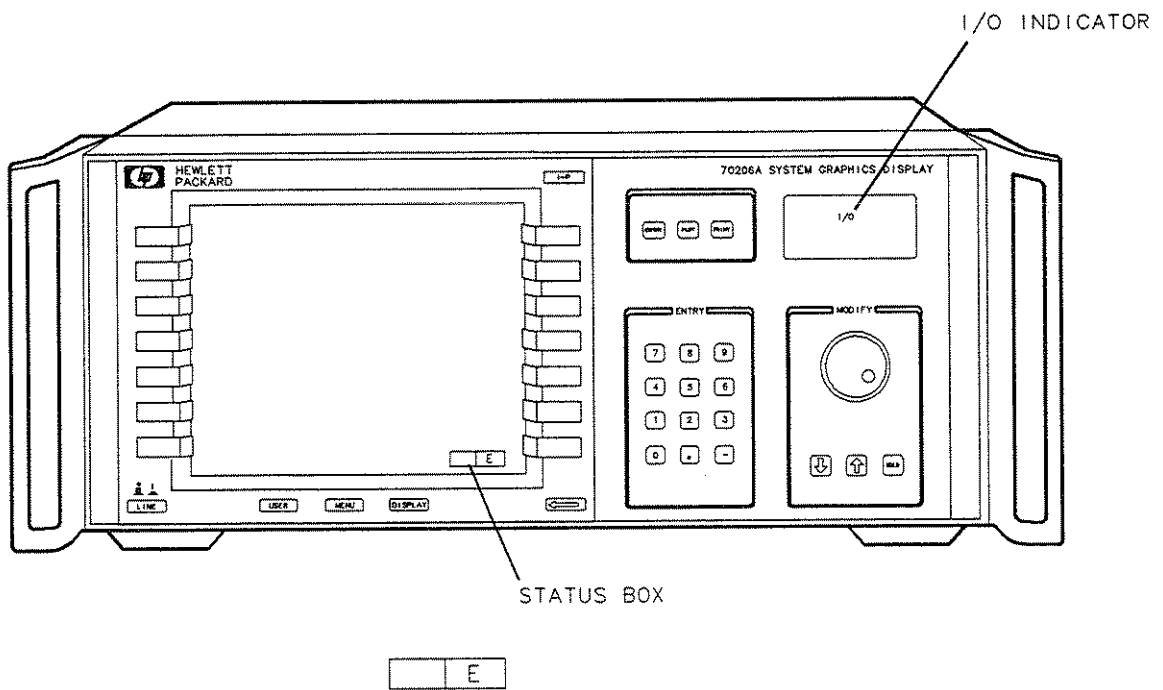

**Figure 5-2. HP 70206A Front-Panel Fault Indicators**

---

## Using the HP-MSIB Troubleshooting Utility

The HP-MSIB Troubleshooting Utility is a firmware routine of the display instrument. It allows you to verify that an element can communicate on the HP-MSIB. By determining which elements can communicate, you can isolate the HP-MSIB problem. However, if the problem is in the mainframe or the display, the utility cannot determine which is faulty. If this is the case, contact your nearest Hewlett-Packard service office listed in Table 1-5.

### Preparing to Use the Utility

To use the utility, you must know the HP-MSIB addresses of the elements. It is recommended that you keep a written list of the HP-MSIB addresses.

---

#### Note



The address map may not function if there is an HP-MSIB problem. After an HP-MSIB problem occurs, the address map cannot be relied on to determine the addresses of the elements.

---

If you do not know the HP-MSIB addresses, they can be identified by checking the switch settings on each module. The HP-MSIB addresses can sometimes be deduced from the HP-IB address of the master and the response of the troubleshooting utility.

---

#### Note



The HP-MSIB Troubleshooting Utility inhibits normal operation of the system. Using the utility may put the system to a state from which you can only recover by cycling power.

---

When the HP-MSIB is not working, the troubleshooting utility cannot be used unless the display is prevented from automatically communicating with other HP-MSIB elements. This is done by purging *all* window assignments of the display.

The **SHOW CONFIG** softkey of the display screen shows which windows are assigned. Use the following procedure to purge window assignments.

1. Press the **DISPLAY** hardkey.
2. Press the **config display** softkey.
3. Press **purge window** softkey.
4. Select the window to be purged by pressing the **▲** or **▼** key. (The window number selected is shown at the lower left-hand corner of the screen.)
5. Press **EXECUTE** to purge the window.
6. Repeat steps 2 through 5 until all windows are purged.
7. Cycle power.

When all window assignments are purged, the User screen will be blank, except for the status block.

## Using the Utility

Use the following procedure to access the HP-MSIB Troubleshooting Utility.

1. Press the **DISPLAY** hardkey.
2. Press **display tests**, then **KNOB TEST**. The CRT display should be similar to the one shown in Figure 5-3. Note that the Knob Test value is 00 (as shown in the center of the circle).
3. With the Knob Test value at 00, press the lower left-hand softkey (unlabeled).

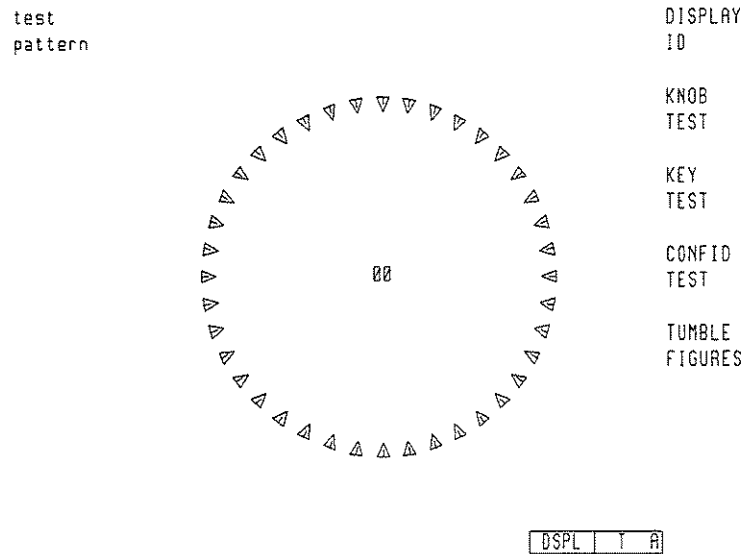

**Figure 5-3. Knob Test Display**

The HP-MSIB Troubleshooting Utility is now displayed as illustrated in Figure 5-4. This utility is entered through an unlabeled softkey to prevent users from accidentally disrupting normal system operation.

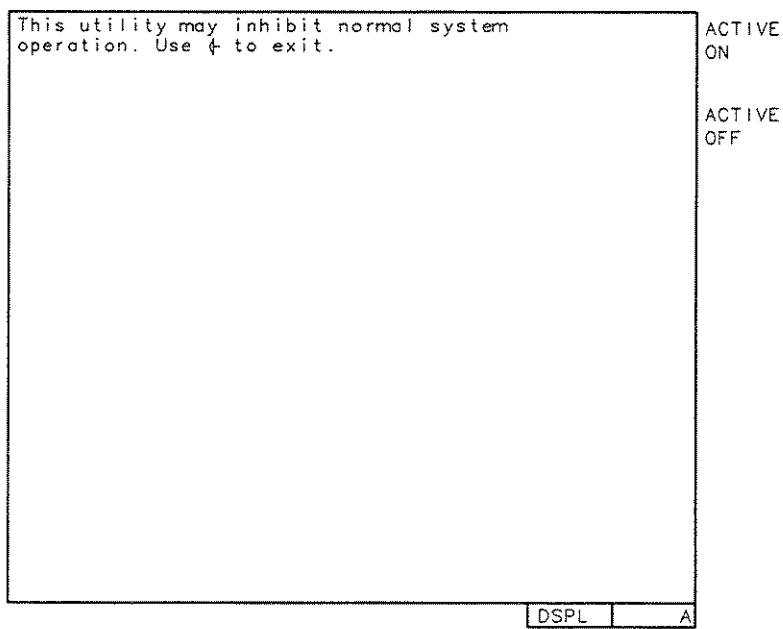

**Figure 5-4. HP-MSIB Troubleshooting Utility**

The utility has two main softkeys: **ACTIVE ON** and **ACTIVE OFF**. (See Figure 5-4.) These softkeys send the HP-MSIB command to turn the active indicator of an element on and off.

Once the command is sent, the display examines the HP-MSIB to see if the element received the instruction. Use the following procedure to send the Active On command.

---

**Note**



The **Module Not Accepting Data** message is returned for a master module if one of its slaves has a faulty HP-MSIB interface. Therefore, verify that all of the slaves of a master can communicate before determining that the master is unable to communicate.

---

1. Press the **ACTIVE ON** softkey.
2. Using the numeric keypad, enter the row address of the module that is to be tested for an HP-MSIB failure.
3. Press the **ENTER** softkey.
4. Enter the column address of the module as a hexadecimal number. Refer to Table 5-1 for decimal-to-hexadecimal conversion information. Use the alphabetical softkeys (Figure 5-5) and the keypad to enter the hexadecimal numbers.
5. Press **ENTER**.

**Table 5-1. Decimal/Hexadecimal Conversion**

Decimal	Hexadecimal	Decimal	Hexadecimal
0	0	16	10
1	1	17	11
2	2	18	12
3	3	19	13
4	4	20	14
5	5	21	15
6	6	22	16
7	7	23	17
8	8	24	18
9	9	25	19
10	A	26	1A
11	B	27	1B
12	C	28	1C
13	D	29	1D
14	E	30	1C
15	F	31	1D

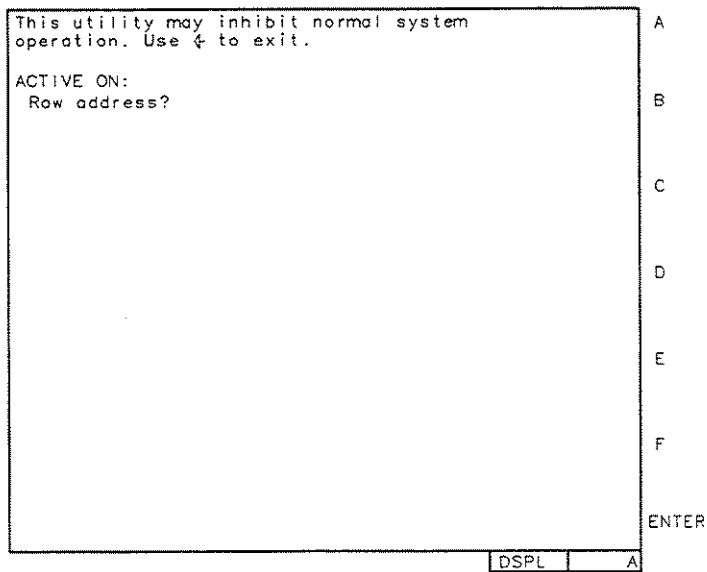

**Figure 5-5. Alphabetical Softkeys**

The utility has a 2-second timeout. Allow 2 seconds for the utility to respond to the **ENTER** softkey. The utility responds by displaying one of the following messages. (Example messages are shown in Figure 5-6.)

- |                           |   |
|---------------------------|---|
| Module not accepting data | This message indicates that there is an element at the specified address, but it cannot communicate on the HP-MSIB.       |
| Communication complete    | This message indicates the HP-MSIB of the element works correctly. Note that the active light of the module should be ON. |
| Module not present        | This message indicates that there is no element at the specified address.   |

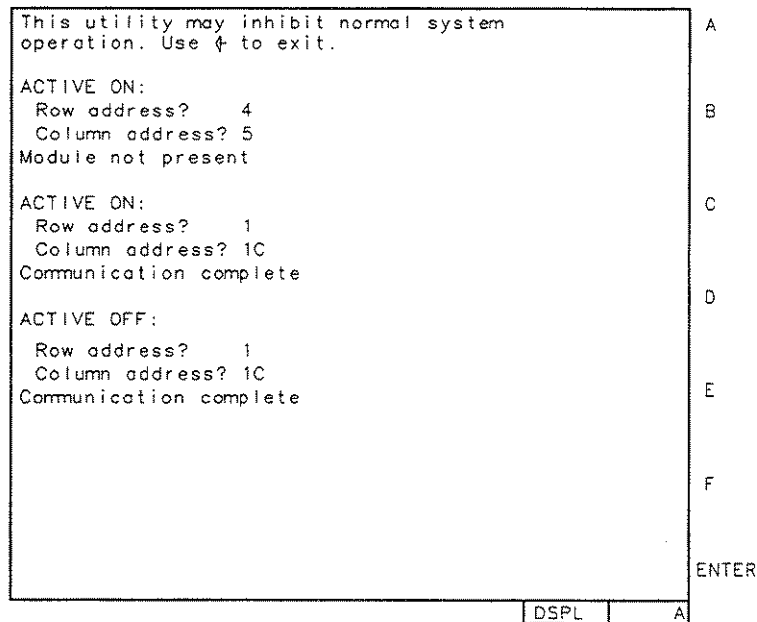

**Figure 5-6. Completed HP-MSIB Communication**

### Interpreting the Utility Results

If only one module cannot communicate on HP-MSIB, that module is faulty. Refer to the appropriate service manual for troubleshooting and repair information.

If none of the elements on the HP-MSIB can communicate, either a module is disrupting the entire HP-MSIB, the mainframe HP-MSIB circuits are faulty, or the display instrument has a faulty HP-MSIB interface and the utility is giving erroneous results. Use the following steps to further isolate the problem.

1. If an abnormal CRT screen is a symptom, refer to both the *HP 70001A Mainframe Service Manual* and to the *HP 70205A and HP 70206A Graphics Displays Service Manual* for further troubleshooting and repair information.
2. If flashing error lights are a symptom, the faulty element or mainframe can be isolated by using the steps given below.

### 5-10 Troubleshooting



---

**Caution**

Turn the mainframe *off* before removing any modules from the mainframe.



- 
- a. Remove the element from the HP-MSIB by removing the module from the mainframe, or by disconnecting the HP-MSIB cables from a stand-alone element.
  - b. Cycle the power.
  - c. If the problem is gone, the element is faulty. Refer to the appropriate Service Manual for further troubleshooting and repair information.
  - d. If the problem remains, repeat steps a through c until the faulty element has been isolated. If none of the elements are faulty, the HP 70001A Mainframe is faulty. Refer to the *HP 70001A Mainframe Service Manual* for further troubleshooting and repair information.

---

**Blank or Distorted Display**

Contact your nearest Hewlett-Packard Service Office listed in Table 1-5.

## Display Tests

The Display Tests are the diagnostic and adjustment routines of the display instruments (for example, the HP 70206A). The Display Tests screen is accessed by pressing **DISPLAY**, then **display tests**. (See Figure 5-7.)

### Note



Keep in mind that display internal adjustments or repairs should only be attempted by qualified technical personnel. Review the “Hazards of Internal Repair or Adjustment” and associated warning notice in Chapter 1.

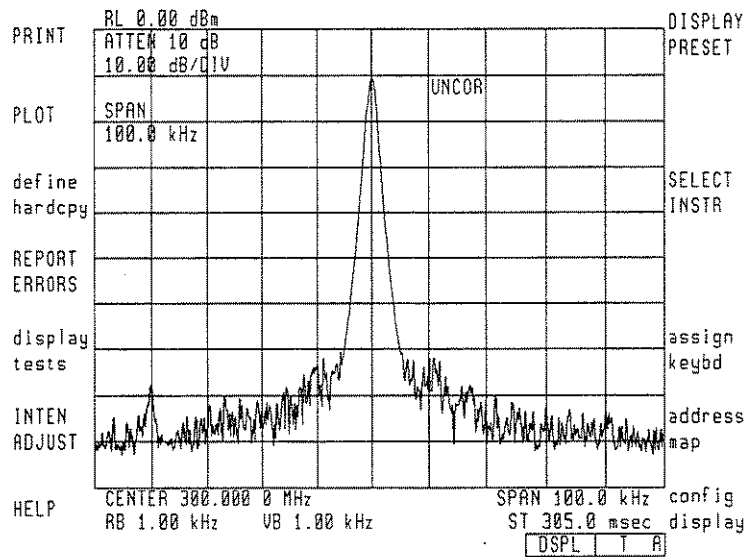

Figure 5-7. **display tests** Softkey

The Display Tests screen softkeys are shown in Figure 5-8 and explained in the following pages.

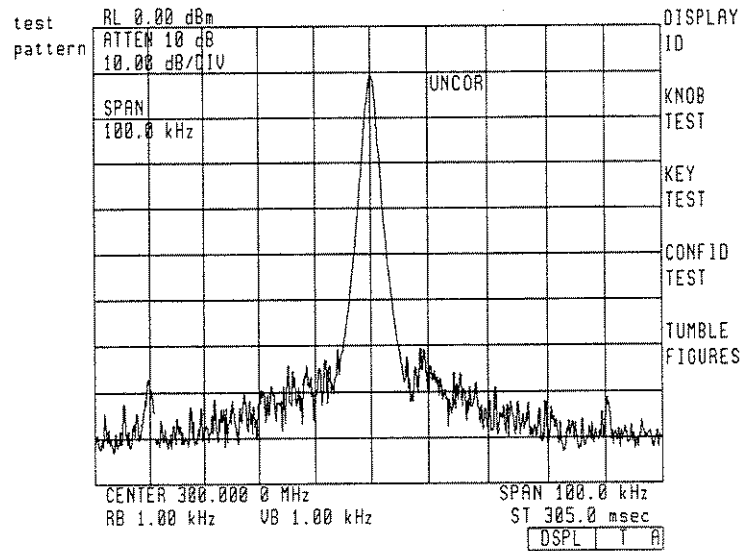

Figure 5-8. **display tests** Screen

### Test Pattern Softkeys

This softkey allows entry of display test patterns which are used to adjust the display. For explanations of the test patterns and related adjustments, refer to the *HP 70205A and HP 70206A Service Manual*.

### Display ID Softkey

When **DISPLAY**, **display tests**, and **DISPLAY ID** keys are pressed, the screen shows the following information (see Figure 5-9):

- HP model number.
- Firmware version.
- HP-MSIB address.
- HP-IB address.
- Dot Generator release.

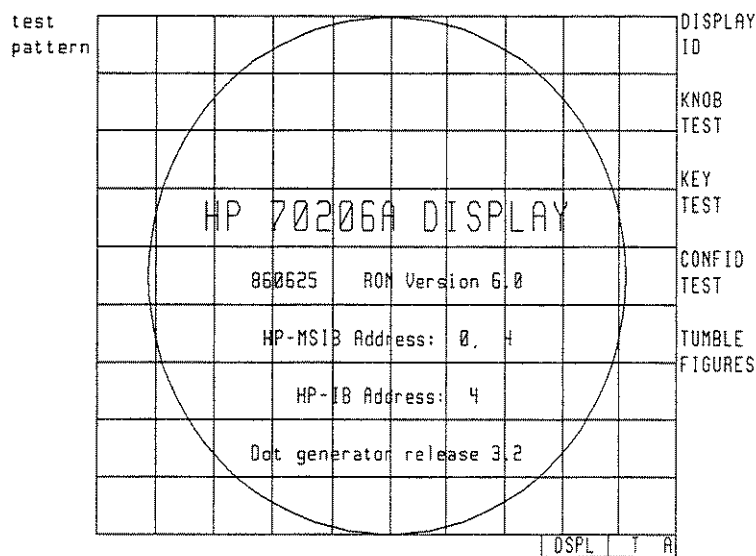

**Figure 5-9. Display ID**

### Knob Test Softkey

The **KNOB KEY** softkey allows the user test the front-panel knob on the display.

EXAMPLE: Use of the **KNOB TEST** softkey.

1. Press the **DISPLAY** hardkey.
2. Press the **display tests** softkey.
3. Press the **KNOB TEST** softkey. See Figure 5-10.
4. Turn the front-panel knob clockwise slowly. The numbers in the center of the Knob Test display should increase one by one (from 00 to 39).
5. Turn the front-panel knob counterclockwise slowly. The numbers in the center of the Knob Test display should decrease.

If the knob is turned swiftly, the numbers should increase swiftly when the knob is turned clockwise and decrease swiftly when turned counterclockwise. (The numbers will change too quickly for you to be able to follow the one-by-one count.)

Exit the routine by pressing the back arrow key **⏪**.

test  
pattern

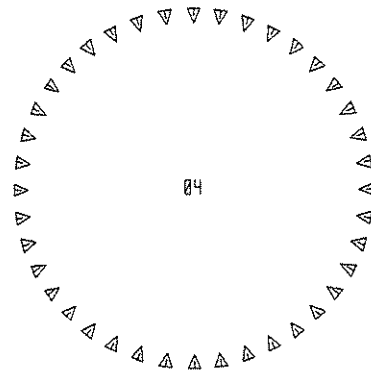

DISPLAY  
ID  
  
KNOB  
TEST  
  
KEY  
TEST  
  
CONFID  
TEST  
  
TUMBLE  
FIGURES

DSPL T A

**Figure 5-10. Knob Test Display**

### Key Test Softkey

The **KEY TEST** softkey allows the user to check the mechanical and electrical operation of every front-panel key on the display.

EXAMPLE: Use of the **KEY TEST** softkey.

1. Press the **DISPLAY** hardkey.
2. Press the **display tests** softkey.
3. Press the **KEY TEST** softkey.
4. Press any key on the display's front panel and it will be echoed on the screen if it is working properly. See Figure 5-11.
5. Press the backspace (back-arrow) key to exit this function.

If an error is detected, contact your nearest Hewlett-Packard service office listed in Table 1-5.

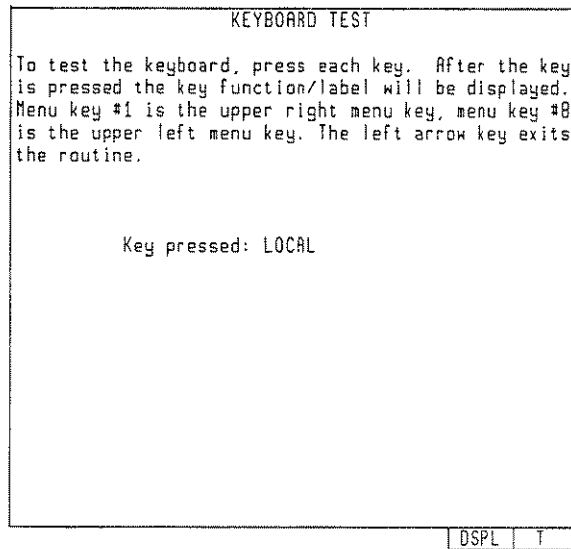

**Figure 5-11. Key Test**

### **Confidence Test (**CONFID TEST** Softkey)**

The Display Confidence Test, initiated by pressing the **CONFID TEST** softkey, checks the operation of roughly 90% of the display unit. If no fault is found, **6001 confidence test passed** appears in the lower-left corner of the screen. If a fault is found, **6008 confidence test failed** is shown. In either case, the character set remains on the display screen.<sup>1</sup> See Figure 5-12.

If an error is detected, contact your nearest Hewlett-Packard service office listed in Table 1-5.

If the display passes the Confidence Test, and the CRT shows no visible distortion, there is a high level of probability that the display instrument is functioning correctly. If the display fails the Confidence Test, it attempts to write E (error) in the display status block.

If the HP-MSIB is working, any error messages produced by the Confidence Test can be viewed by pressing the **REPORT ERRORS** softkey of the **DISPLAY** screen.

---

<sup>1</sup> *Compatibility Note:* In Display ROM Version 5.0 the character set is not left on the screen after the confidence test. If problems persist, contact your nearest Hewlett-Packard service office listed in Table 1-5.

At power-on, a set of tests that is more comprehensive than the Confidence Test is run. The set of tests run at power-on includes tests for the HP-MSIB capability of the display instrument. The display indicates if any of these tests fail, but does not indicate if they pass. An HP-MSIB failure is indicated by a blinking E (error) indicator in the status block.

test	DISPLAY
pattern	ID
	KNOB
	TEST
	KEY
0 1 2 3 4 5 6 7 8 9 : ; < = > ? ! " # \$ % & ' ( ) * + , - . / 0 1 2 3 4 5 6 7 8 9 : ; < = > ? @ A B C D E F G H I J K L M N O P Q R S T U V W X Y Z [ \ ] ^ _ ` a b c d e f g h i j k l m n o p q r s t u v w x y z {   } ~ o ' : ; ' , ' - . / 0 1 2 3 4 5 6 7 8 9 : ; < = > ? ü æ þ ÿ ð é ê ë ì í î ï ð ñ ò ó ô õ ö ø ù ú û ü ý ÿ	KEY TEST
	CONFID TEST
	TUMBLE FIGURES

6001 Confidence test passed

DISP | T | A

Figure 5-12. Confidence Test

### Tumble Figures Softkey

**Note**



While the tumble figures are running, the display cannot communicate on either HP-IB or HP-MSIB. Nor can the display respond to any front-panel keys except the back arrow key and the **TUMBLE FIGURES** softkeys used to select the various demonstration figures.

The **TUMBLE FIGURES** softkey allows the user to chose five different demonstration routines:

EXAMPLE: Use of the **TUMBLE FIGURES** softkey.

1. Press the **DISPLAY** hardkey.
2. Press the **display tests** softkey.
3. Press the **TUMBLE FIGURES** softkey.
4. Press one of the following softkeys: **CUBE**, **BALL**, **SLAB**, **ROD**, or **HALF**.

---

## Error Codes and Messages

---

### Note



Before taking any action based on these error messages, make sure all the boards are firmly seated and all cables are securely fastened.

---

HP 70205A and HP 70206A graphics-display error-code information is provided in this section. Errors may result when the display module is configured normally or is on the module service extender. Numerical error codes and brief error messages are reported on the display. Error codes fall into four categories:

- 2000—2999 Usage Errors.
- Display-Disruptive Errors.
- 6000—6999 Hardware-Warning Errors.
- 7000—7999 Hardware-Broken Errors.

### 2000—2999 Usage Errors

Usage errors are those that occur during normal display operation and usually indicate an error elsewhere in the system.

#### 2001 Illegal Command

The display has been sent a command it does not recognize. (For example, in HP BASIC the command `OUTPUT @Display;"XX"` would generate this error.)

#### 2002 Illegal Parameter

An item has been sent a command that does not match (for example, sending LB to a PA type item), a CL command has been sent in GP0, or a bad learn string has been sent.

#### 2005 Illegal character set

An attempt has been made to specify a character set (using CA or CS) that is not available in the display.

#### 2006 Parm out to Range

A parameter that violates the range specification for a given command has been sent.

#### 2007 Missing terminator

A command has been sent to the display without a valid terminator.

#### 2009 Protocol error

A command has been sent to the display that requires a link type that is not currently established between the sender and the display.



## **2011 Memory overflow**

An attempt has been made to allocate more vector list memory than the display contains. Usually this means that the user is trying to display more traces than the display's memory can support, or that too many strokes have been sent in "non-referenced" graphics.

## **Display-Disruptive Error Messages**

Display-disruptive errors are those that interfere with normal display operation and error reporting. The associated error messages indicate faulty display hardware. The error messages are shown in two ways:

- The error message in large block letters on an otherwise blank display.
- An LED pattern on the A6 Host Board Assembly.

### **A3 CALL FAILED (ROM Version 6.0 and later)**

The A3 bit-slice processor failed to call a subroutine after the A6 host processor wrote a special program that tested the ability of the A3 bit-slice processor to call a subroutine.

### **A3 CHAR ROM (ROM Version 6.0 and later)**

A test of the A3 character ROM failed after the A6 host processor caused the A3 bit-slice processor to read a space character from the character ROM and write it to A4 Pixel RAM.

### **A3 CHAR ROM (ROM Version 5.0)**

### **A3 CHAR SET (ROM Version 6.0 and later)**

A test of the A3 Character set failed. The A6 host processor caused the A3 bit-slice processor to write all the characters in the character ROM to the screen. A signature of the data in screen memory was taken by the host processor and compared to the stored signature for that ROM. Because they disagreed, the test failed.

### **A3 COND WRITE**

The A3 bit-slice processor overwrote data on the screen, indicating a failure of the conditional write circuitry.

### **A3 DOT WRITE**

The A3 bit-slice processor failed to do a valid dot-write to A4 Pixel RAM.

### **A3 LIMITS ERR**

The limit circuitry failed to prevent the A3 bit-slice processor from writing dots to the vector list.

### **A3 MARK FAILED**

The A3 bit-slice processor failed to mark an instruction. The first time any instruction is executed, the A3 processor marks that instruction by setting a specific bit. The A6 Host processor then checks for the unmarked instruction.

### **A3 MEMORY ADDRESS**

The A3 bit-slice processor made an unsuccessful attempt to access A4 RAM. The A6 host processor first caused the A3 bit-slice processor to write data to a RAM location. The A6 host processor then read the RAM location directly and compared this data with the data written. This read/write operation was repeated for each RAM location and failed at some location.

### **A3 MEMORY ARB**

The A6 host processor and A3 bit-slice processor have failed to share access to A4 Pixel RAM.

### **A3 RETURN FAILED**

The A3 bit-slice processor executed a subroutine, but did not return to the mainline program.

### **A3 MEMORY R/W**

The A3 bit-slice processor made an unsuccessful attempt to access A4 pixel RAM. The A6 host processor caused the A3 bit-slice processor to perform a write/read to pixel RAM. The A6 host processor then compared the data actually written to RAM with two values: the data written by, and the data read by, the A3 bit-slice processor. Both comparisons failed.

### **A3 MEMORY READ**

The A3 bit-slice processor made an unsuccessful attempt to access A4 pixel RAM. The A6 host processor first caused the A3 bit-slice to perform a write/read to pixel RAM. The A6 host processor then read pixel RAM directly and compared this data with the data read by the A3 bit-slice processor. The comparison failed.

### **A3 MEMORY SYNC**

The synchronization between the A3 bit-slice processor and the A6 host processor in accessing the A4 Pixel RAM has failed.

### **A3 MEMORY WRITE**

The A3 bit-slice processor made an unsuccessful attempt to access A4 pixel RAM. The A6 host processor first caused the A3 bit-slice processor to write data to pixel RAM. The A6 host processor then read pixel RAM directly and compared this data with the data written to pixel RAM. The comparison failed.

### **A3 SERIAL INTERFACE**

A failure occurred with the serial interface between the A6 host processor and the A3 bit-slice processor. The A6 host processor performed a write/read to the A3 bit-slice processor, then attempted unsuccessfully to verify the returned data.

### **A3 START VECTOR**

The A3 bit-slice processor failed to read its start vector or jump correctly.

### **A3 WORD WRITE**

The A3 bit-slice processor failed to do a valid word-write to A4 Pixel RAM.

### **A3 WRONG DATE CODE**

The firmware date code of the A3 bit-slice processor found that its date code does not match that of the A6 host processor.

### **A3 ??? FAILED (ROM Version 5.0)**

### **A3 UNKNOWN (ROM Version 6.0 and later)**

The A6 host processor does not know what failed on the A3 Dot Generator Board. The host processor did not successfully execute the power-up confidence test.

### **A4 PIXEL RAM**

The A6 host processor attempted unsuccessfully to communicate with A4 Pixel RAM. Pixel RAM is tested by writing data to each address location that equals the address of that location. After the data is written, the host reads each address to see if the data equals the location address. In ROM Version 6.0 a second line is displayed to identify the failed IC.

### **A6 RAM ADDR ERROR**

A test of CMOS RAM has failed. The data in CMOS RAM is read, saved, and complemented. Every other address is then tested to see if the data is unchanged. The test failed.

### **A6 RAM DATA ERROR (LOW) (ROM Version 5.0)**

### **A6 RAM DATA ERROR (HIGH) (ROM Version 5.0)**

### **A6 RAM DATA ERROR (U37) (ROM Version 6.0 and later)**

### **A6 RAM DATA ERROR (U38) (ROM Version 6.0 and later)**

A test of CMOS RAM has failed. Data is cycled through all the address locations on the data bus. Each time data is written, it is read back and compared with the written data. At least one comparison failed.

### **A6 ROM CHECKSUM 3,2,1 and/or 0 (ROM Version 5.0)**

### **A6 ROM 39 CHECKSUM (ROM Version 6.0 and later)**

### **A6 ROM 40 CHECKSUM (ROM Version 6.0 and later)**

### **A6 ROM 47 CHECKSUM (ROM Version 6.0 and later)**

### **A6 ROM 48 CHECKSUM (ROM Version 6.0 and later)**

A checksum was calculated on all ROMs and one or more ROMs failed.

## **A6 8041 INTERFACE**

Communications failed between the A6 8041 processor chip and the A6 host processor chip. The 8041 processor chip is instructed to send a data sequence to the host processor chip, which if received correctly should verify the 8041 and the link to it.

### **A6 Exception-Processing Errors**

These display-disruptive error messages are generated by the A6 host processor for actions that are outside the normal processing associated with the execution of instructions. Exception processing is associated with interrupts, trap instructions, tracing, and other exceptional conditions. Activities that result in these error codes in most cases takes place on the A6 Host Board Assembly.

The exception-processing error messages appear on-screen as:

```
EXCEPTION AT XXXXXX (XXXXXX = hex address)
MESSAGE
```

### **6000-6999 Hardware-Warning Errors**

The following error codes are generated by faults that may impair measurement accuracy. These errors will be noted by the E in the lower-right of the CRT. The errors may be viewed by pressing the **DISPLAY** key and then the **REPORT ERRORS** softkey.

#### **6002 A6 RAM checksum (ROM Version 5.0)**

#### **6002 A6 RAM checksum (battery?) (ROM Version 6.0 and later)**

A6 RAM memory failed a checksum test. If cycling LINE power does not clear the error, replace the battery in the rear-panel battery compartment. If the problem persists, replace the A6 Host Board Assembly.

#### **6008 Confidence Test Failed**

A display self-test has failed. Confidence Test Failed appears on the bottom of the screen at power-up (if an error was detected) or after a confidence test **CONFID TEST**. The **CONFID TEST** softkey invokes a test which is a sequential execution of tests 11, 8, 14, and 12. The same test sequence can be invoked remotely with the TE command. If any test fails, the bus which sent the TE command will be notified. If this occurs because of a TE command, cycle power; a display-disruptive error should be displayed, which will indicate the problem. If this occurs at power-up, press **DISPLAY** and **REPORT ERRORS** will identify the problem.

### **7000-7999 Hardware-Broken Errors**

The following error codes are generated by faults within the instrument. These errors will be noted by the E in the lower-right of the CRT. The errors may be viewed by pressing the **DISPLAY** key and then the **REPORT ERRORS** softkey.

#### **7036 HP-MSIB error**

The A6 host processor attempted unsuccessfully to communicate over HP-MSIB. The host processor sent data to HP-MSIB address row 0, column 31 and checked for NMAA (no module at address), which is the expected response. The host processor also sent data to itself

## **5-22 Troubleshooting**

over HP-MSIB and checked the returned data. Possible causes: The A6 Host Board Assembly, or the HP-MSIB. Troubleshoot as in the “Blinking E and Other HP-MSIB Problems” section of this chapter.

#### **7037 A3 Char ROM (ROM Version 5.0)**

#### **7037 A3 Character set (ROM Version 6.0 and later)**

A test of the A3 Character set failed. After the A6 host processor caused the A3 bit-slice processor to write all the characters in the Character ROM to the screen. A signature of the data in screen memory was taken by the host processor and compared to the stored signature for that ROM. Because they disagreed, the test failed.

#### **7038 A6 Error in 8041**

Communications failed between the A6 8041 processor and the A6 host processor. The 8041 processor is instructed to send a data sequence to the host processor, which if received correctly should verify the 8041 and the link to it.

#### **7039 A4 Memory**

The A6 host processor attempted unsuccessfully to communicate with A4 Pixel RAM. Pixel RAM is tested by writing data to each address location that equals the address of that location. After the data is written, the host reads each address to see if the data equals the location address.

#### **7040 A3 Dot gen**

A test of the A3 Dot Generator Board failed. The A6 host processor caused the A3 bit-slice processor to draw an octagonal test pattern on the display. The host processor then computed a signature on screen memory to see if the bit-slice processor has written the correct data.

#### **7048 A3 Wrong datecode**

A check of the A3 bit-slice processor firmware datecode failed. Any datecode less than 3.0 fails.

#### **7068 A3 Conditional write**

The A3 bit-slice processor overwrote data on the screen, indicating a failure of the conditional write circuitry.

#### **7069 A3 Word write**

The A3 bit-slice processor failed to do a valid word-write to A4 Pixel RAM.

#### **7070 A3 Dot write**

The A3 bit-slice processor failed to do a valid dot-write to A4 Pixel RAM.

#### **7071 A3 Limit error**

The limit circuitry failed to prevent the A3 bit-slice processor from writing dots to the vector list.

#### **7072 A3 Memory arbitration**

The A6 host processor and A3 bit-slice processor have failed to share access to A4 Pixel RAM.

#### **7049 A3 Character ROM (ROM Version 6.0 and later)**

A test of the A3 character ROM failed. The A6 host processor caused the A3 bit-slice processor to read a space character from the character ROM and write it to A4 pixel RAM.

#### **7050 A3 Sub return**

The A3 bit-slice processor executed but failed to return from a subroutine. The A6 host processor wrote a special program to test the ability of the bit-slice processor to execute and return from a subroutine.

#### **7051 A3 Instruction mark**

The A3 bit-slice processor failed to mark an instruction, which indicates the instruction has been executed by the bit-slice processor. The A6 host processor wrote a special program that tests the ability of the bit-slice processor to mark an instruction. The test failed.

#### **7052 A3 Unknown failure**

The A6 host processor does not know what failed on the A3 Dot Generator Board. The host processor did not successfully execute the power-up confidence test.

#### **7053 A3 Subroutine call**

The A3 bit-slice processor failed to call a subroutine. The A6 host processor wrote a special program to test the ability of the A3 bit-slice processor to call a subroutine. The test failed.

#### **7054 A3 Memory sync**

The synchronization between the A3 bit-slice processor and the A6 host processor in accessing the A4 pixel RAM has failed.

#### **7055 A3 Serial interface**

The serial interface between the A6 host processor and the A3 bit-slice processor has failed. The host processor performed a write/read over the serial interface to the A3 bit-slice processor, then attempted to verify the returned data.

#### **7056 A3 Memory read**

The A3 bit-slice processor made an unsuccessful attempt to access A4 Pixel RAM. The A6 host processor first caused the bit-slice processor to perform a write/read to pixel RAM. The host processor then read pixel RAM directly and compared this read data with the data read by the A3 bit-slice processor. The comparison failed.

#### **7057 A3 Memory write**

The A3 bit-slice processor made an unsuccessful attempt to access A4 Pixel RAM. The A6 host processor first caused the bit-slice processor to write data to pixel RAM. The host processor then read pixel RAM directly and compared this read data with the data written to pixel RAM. The comparison failed.

#### **5-24 Troubleshooting**

### **7058 A3 Memory R/W**

The A3 bit-slice processor made an unsuccessful attempt to access A4 Pixel RAM. After the A6 host processor caused the bit-slice processor to perform a write/read to pixel RAM. The host processor compared the data actually written to pixel RAM with two values: the data written by, and the data read by, the A3 bit-slice processor. Both comparisons failed.

### **7059 A3 Memory address**

The A3 bit-slice processor made an unsuccessful attempt to access A4 Pixel RAM. After the A6 host processor first caused the bit-slice processor to write data to a pixel RAM location. The host processor then read the pixel RAM location directly and compared this read data with the data written. This write/read operation was repeated for each pixel RAM location. At least one of the comparisons failed.

### **7060 A6 RAM Data (U37)**

### **7061 A6 RAM Data (U38)**

A test of CMOS RAM has failed. Data is cycled through all the address locations on the data bus. Each time data is written, it is read back and compared with the written data. At least one test failed.

### **7062 A6 RAM Address**

A test of CMOS RAM has failed. The data in CMOS RAM is read, saved, and complemented. Every other address is then tested to see if the data is unchanged.

### **7063 A6 ROM U39 Checksum**

### **7064 A6 ROM U40 Checksum**

### **7065 A6 ROM U47 Checksum**

### **7066 A6 ROM U48 Checksum**

A checksum is calculated on all ROMs.

### **7067 A3 Start vector**

The A3 bit-slice processor failed to read its start vector or jump correctly.





# Index

---

## A

- accessories, 1-5
  - static safe, 1-17
- accessories supplied, 1-5
- addressing
  - HP 70205A, 2-2
  - HP 70206A, 2-7
- addressing (HP 70205A)
  - HP-MSIB,, 2-2
- addressing (HP 70206A)
  - HP-MSIB, 2-7
- adjustment
  - intensity, 2-12
- adjustments
  - hazards, 1-15

## B

- battery
  - abuse, 1-10
  - cover, 1-10
  - disposal, 1-10
  - replacing, 1-10
- blank display, 5-11
- blinking E, 5-2

## C

- cables
  - HP 70205A, 1-5
  - HP 70206A, 1-5
  - HP-MSIB, 1-5
  - power, 1-5
- cautions in manual, 1-3
- cleaning
  - CRT/display screen, 1-15
- codes
  - error, 5-18
  - messages, 5-18
- composite video (HP 70205A)
  - rear-panel output, 3-2
- composite video (HP 70206A)
  - rear-panel output, 3-3
- confidence test, 4-1, 5-1, 5-16
- containers
  - static shielding, 1-16
- country of origin, 1-3

## CRT

- cleaning, 1-15

## D

- damaged
  - shipping container, 1-4
- date
  - configuration change, 1-3
- dimensions (HP 70205A), 3-2
- dimensions (HP 70206A), 3-3
- display
  - blank, 5-11
  - connecting to mainframe, 2-10
  - distorted, 5-11
- display address (HP 70205A)
  - switches, 2-3
- display address (HP 70206A)
  - switches, 2-9
- display description, 1-2
- display ID, 5-13
- display tests, 5-12
- distorted display, 5-11

## E

- electronic components
  - care and handling, 1-16
- electrostatic discharge information, 1-15
- electrostatic discharge protection
  - floor mat, 1-15
  - heel strap, 1-15
  - table mat, 1-15
  - wrist strap, 1-15
- element
  - functional term, 1-2
- EMI (HP 70205A)
  - specifications, 3-2
- EMI (HP 70206A)
  - specifications, 3-3
- ERR indicator, 5-2
- error
  - codes, 5-18
  - messages, 5-18
- ESD damage
  - reducing, 1-16
- ESD protection
  - heel strap, 1-15

- table mat, 1-15
- wrist strap, 1-15
- EST protection
  - floor mat, 1-15

## F

- fan noise
  - HP 70206A, 5-1
- fault indicator
  - airflow, 5-1
  - blinking E, 5-2
  - ERR indicator, 5-2
  - HP 70205A, 5-2
  - HP 70206A, 4-1
  - I/O, 5-1
  - status box, 5-2
- fault indicators
  - HP 70206A, 5-3
- front panel features
  - HP 70205A, 1-11
  - HP 70206A, 1-13
- front/rear panel
  - features, 1-11
- functional term
  - element, 1-2
  - independent element, 1-2
  - instrument, 1-2
  - slave, 1-2
- functional terms, 1-2
  - master, 1-2
  - sub-master, 1-2
- fuse
  - location, 2-7
  - open, 5-2
  - replacement, 2-7
  - size, 2-7

## H

- hardkey
  - DISPLAY, 1-1
  - DSP, 1-1
- hardkeys, 1-1
- help
  - sales and service, 1-17
- HP 70206A
  - installation, 2-6
- HP-IB
  - setting the address switch (HP 70205A), 2-3
  - setting the address switch (HP 70206A), 2-9
- HP-IB on/off
  - switch, 2-3, 2-9
- HP-MSIB
  - addressing (HP 70205A), 2-2
  - addressing (HP 70206A), 2-7
  - cables, 1-5

- cabling, 2-10
- problem, 5-3
- setting address switches (HP 70205A), 2-3
- setting address switches (HP 70206A), 2-8
- troubleshooting, 5-4
- HP-MSIB troubleshooting utility, 5-6

## I

- incomplete
  - shipping container, 1-4
- independent element
  - functional term, 1-2
- indicator light
  - I/O, 5-4
- initial inspection, 1-4
- installation
  - HP 70205A, 2-2, 2-5
  - HP 70206A, 2-6
  - module, 2-5
- instrument
  - functional term, 1-2
- instrument cabinets
  - interconnecting, 1-9
- intensity
  - adjustment, 2-12
- interconnect
  - instrument cabinets, 1-9
  - System II cabinets, 1-9
- internal repair
  - hazards, 1-15
- I/O indicator light, 5-4

## K

- key test, 5-15
- knob test, 5-14

## L

- label
  - serial number, 1-3
- line fuse
  - HP 70206A, 5-2
- line voltage
  - selector, 2-6

## M

- mainframe
  - connecting to display, 2-10
  - structural term, 1-2
- manual updating, 1-4
- master
  - functional term, 1-2
- modular measurement terms, 1-1
- module
  - installation, 2-5

- structural term, 1-2
- N**
- nominal values, 3-1
  - notation
    - fixed-label keys, 1-1
    - hardkeys, 1-1
    - softkey labels, 1-1
- O**
- offices
    - sales and service, 1-17
  - operation
    - remote, 2-11
  - option
    - 010, 1-6
    - 400, 1-6
    - 400 Hz, 1-6, 2-12
    - 908, 1-6
    - 913, 1-6
    - additional return-to-HP service, 1-6
    - interconnect kit, 1-6
    - rack mount, 1-6
    - rack slide, 1-6
    - W30, 1-6
  - options, 1-6
- P**
- packaging, 1-4
    - containers, 1-19
    - material, 1-19
    - materials, 1-20
    - return instruments, 1-19
  - power
    - cables, 1-5
  - power cable
    - protective conductor, 2-6
  - power requirements
    - HP 70206A, 3-3
  - prefix
    - serial number, 1-3
  - preparation for use
    - HP 70205A, 2-2
    - HP 70206A, 2-6
- R**
- rack mount installation, 1-6
  - rear panel features
    - HP 70205A, 1-12
    - HP 70206A, 1-14
  - rear-panel output
    - composite video (HP 70205A), 3-2
    - composite video (HP 70206A), 3-3
  - remote
    - operation, 2-11
  - return instruments
    - service, 1-19
    - shipping preparation, 1-19
- S**
- safety considerations, 1-3
  - safety markings, 1-3
  - sales and service offices, 1-17
  - screen cleaning
    - display, 1-15
  - selector
    - line voltage, 2-6
  - self-test
    - power-on, 4-1
  - serial number, 1-3
    - label, 1-3
    - prefix, 1-3
    - suffix, 1-3
  - service
    - office, 1-17
    - return instruments, 1-19
  - setting address switches (HP 70205A)
    - HP-MSIB, 2-3
  - setting address switches (HP 70206A)
    - HP-MSIB, 2-8
  - setting the address switch (HP 70205A)
    - HP-IB, 2-3
  - setting the address switch (HP 70206A)
    - HP-IB, 2-9
  - shipping container
    - damaged, 1-4
    - incomplete, 1-4
  - shipping containers, 1-19
  - slave
    - functional term, 1-2
  - softkey labels, 1-1
  - specifications, 3-1
    - EMI (HP 70205A), 3-2
    - EMI (HP 70206A), 3-3
    - power requirements (HP 70206A), 3-3
    - temperature (HP 70205A), 3-2
    - temperature (HP 70206A), 3-3
  - stand-alone instrument
    - structural term, 1-2
  - static safe
    - accessories, 1-17
    - work station, 1-15
  - status box, 5-2
  - structural term
    - mainframe, 1-2
    - module, 1-2
    - stand-alone instrument, 1-2
  - structural terms, 1-2
  - sub-master

- functional term, 1-2
- suffix
  - serial number, 1-3
- supplement
  - manual updating, 1-4
- switch
  - A1—A5, 2-4
  - A1—A8, 2-9
  - A6—A8, 2-3, 2-9
  - HP-IB on/off, 2-3, 2-9
  - system controller, 2-4, 2-9
  - talk only, 2-4, 2-9
  - test mode, 2-4, 2-9
- switches
  - display address (HP 70205A), 2-3
  - display address (HP 70206A), 2-9
- system controller
  - switch, 2-4, 2-9
- System II cabinets, 1-9

## T

- talk only
  - switch, 2-4, 2-9
- temperature (HP 70205A)
  - specifications, 3-2
- temperature (HP 70206A)
  - specifications, 3-3
- test

- confidence, 5-16
- key, 5-15
- knob, 5-14
- test mode
  - switch, 2-4, 2-9
- test pattern, 5-13
- tests
  - display, 5-12
- top cover
  - removal, 1-15
- transformer
  - in-line isolation (400 Hz), 1-6
- troubleshooting utility
  - HP-MSIB, 5-6
- tumble figures, 5-17
- turn on
  - display, 5-1

## U

- updating manuals, 1-4

## W

- warnings in manual, 1-3
- warranted performance, 3-1
- weight (HP 70205A), 3-2
- weight (HP 70206A), 3-3
- work station
  - static safe, 1-15