

## About this Manual

We've added this manual to the Agilent website in an effort to help you support your product. This manual is the best copy we could find; it may be incomplete or contain dated information. If we find a more recent copy in the future, we will add it to the Agilent website.

## Support for Your Product

Agilent no longer sells or supports this product. Our service centers may be able to perform calibration if no repair parts are needed, but no other support from Agilent is available. You will find any other available product information on the Agilent Test & Measurement website, [www.tm.agilent.com](http://www.tm.agilent.com).

## HP References in this Manual

This manual may contain references to HP or Hewlett-Packard. Please note that Hewlett-Packard's former test and measurement, semiconductor products and chemical analysis businesses are now part of Agilent Technologies. We have made no changes to this manual copy. In other documentation, to reduce potential confusion, the only change to product numbers and names has been in the company name prefix: where a product number/name was HP XXXX the current name/number is now Agilent XXXX. For example, model number HP8648A is now model number Agilent 8648A.

# **User's Guide**

## **HP 70340A/70341A**

### **Signal Generators**



**HP Part No. 5960-7096**  
**Printed in USA September 1992**

**Edition B.0.0**

**Notice**

The information contained in this document is subject to change without notice.

Hewlett-Packard makes no warranty of any kind with regard to this material, including, but not limited to, the implied warranties of merchantability and fitness for a particular purpose. Hewlett-Packard shall not be liable for errors contained herein or for incidental or consequential damages in connection with the furnishing, performance, or use of this material.

**Restricted Rights Legend.**

Use, duplication, or disclosure by the U.S. Government is subject to restrictions as set forth in subparagraph (c) (1) (ii) of the Rights in Technical Data and Computer Software clause at DFARS 252.227-7013 for DOD agencies, and subparagraphs (c) (1) and (c) (2) of the Commercial Computer Software Restricted Rights clause at FAR 52.227-19 for other agencies.

©Copyright Hewlett-Packard Company 1992

All Rights Reserved. Reproduction, adaptation, or translation without prior written permission is prohibited, except as allowed under the copyright laws.  
1400 Fountaingrove Parkway, Santa Rosa, CA 95403-1799, USA

---

## Certification

Hewlett-Packard Company certifies that this product met its published specifications at the time of shipment from the factory. Hewlett-Packard further certifies that its calibration measurements are traceable to the United States National Institute of Standards and Technology, to the extent allowed by the Institute's calibration facility, and to the calibration facilities of other International Standards Organization members.

---

## Warranty

This Hewlett-Packard instrument product is warranted against defects in material and workmanship for a period of one year from date of shipment. During the warranty period, Hewlett-Packard Company will, at its option, either repair or replace products which prove to be defective.

For warranty service or repair, this product must be returned to a service facility designated by Hewlett-Packard. Buyer shall prepay shipping charges to Hewlett-Packard and Hewlett-Packard shall pay shipping charges to return the product to Buyer. However, Buyer shall pay all shipping charges, duties, and taxes for products returned to Hewlett-Packard from another country.

Hewlett-Packard warrants that its software and firmware designated by Hewlett-Packard for use with an instrument will execute its programming instructions when properly installed on that instrument. Hewlett-Packard does not warrant that the operation of the instrument, or software, or firmware will be uninterrupted or error-free.

### LIMITATION OF WARRANTY

The foregoing warranty shall not apply to defects resulting from improper or inadequate maintenance by Buyer, Buyer-supplied software or interfacing, unauthorized modification or misuse, operation outside of the environmental specifications for the product, or improper site preparation or maintenance.

NO OTHER WARRANTY IS EXPRESSED OR IMPLIED. HEWLETT-PACKARD SPECIFICALLY DISCLAIMS THE IMPLIED WARRANTIES OF MERCHANTABILITY AND FITNESS FOR A PARTICULAR PURPOSE.

### EXCLUSIVE REMEDIES

THE REMEDIES PROVIDED HEREIN ARE BUYER'S SOLE AND EXCLUSIVE REMEDIES. HEWLETT-PACKARD SHALL NOT BE LIABLE FOR ANY DIRECT, INDIRECT, SPECIAL, INCIDENTAL, OR CONSEQUENTIAL DAMAGES, WHETHER BASED ON CONTRACT, TORT, OR ANY OTHER LEGAL THEORY.

---

## Assistance

*Product maintenance agreements and other customer assistance agreements are available for Hewlett-Packard products.*

*For any assistance, contact your nearest Hewlett-Packard Sales and Service Office.*

---

## Safety Symbols

The following safety symbols are used throughout this manual. Familiarize yourself with each of the symbols and its meaning before operating this instrument.

---

**CAUTION**     The *CAUTION* sign denotes a hazard. It calls attention to a procedure which, if not correctly performed or adhered to, could result in damage to or destruction of the product or the user's work. Do not proceed beyond a *CAUTION* sign until the indicated conditions are fully understood and met.

---

**WARNING**     The *WARNING* sign denotes a hazard. It calls attention to a procedure which, if not correctly performed or adhered to, could result in injury to the user. Do not proceed beyond a *WARNING* sign until the indicated conditions are fully understood and met.

---

**DANGER**     The *DANGER* sign denotes an imminent hazard to people. It warns the reader of a procedure which, if not correctly performed or adhered to, could result in injury or loss of life. Do not proceed beyond a *DANGER* sign until the indicated conditions are fully understood and met.

---

---

## General Safety Considerations

---

- WARNING**
- The instructions in this document are for use by qualified personnel only. To avoid electrical shock, do not perform any servicing unless you are qualified to do so.
  - The opening of covers or removal of parts is likely to expose dangerous voltages. Disconnect the instrument from all voltage sources while it is being opened.
  - The power cord is connected to internal capacitors that may remain live for five seconds after disconnecting the plug from its power supply.
  - This is a Safety Class 1 Product (provided with a protective earthing ground incorporated in the power cord). The mains plug shall only be inserted in a socket outlet provided with a protective earth contact. Any interruption of the protective conductor inside or outside of the instrument is likely to make the instrument dangerous. Intentional interruption is prohibited.
  - For continued protection against fire hazard, replace fuse only with same type and ratings, (type nA/nV). The use of other fuses or materials is prohibited.
- 

- WARNING**
- Before this instrument is switched on, make sure it has been properly grounded through the protective conductor of the ac power cable to a socket outlet provided with protective earth contact.  
  
Any interruption of the protective (grounding) conductor, inside or outside the instrument, or disconnection of the protective earth terminal can result in personal injury.
  - Before this instrument is switched on, make sure its primary power circuitry has been adapted to the voltage of the ac power source.  
  
Failure to set the ac power input to the correct voltage could cause damage to the instrument when the ac power cable is plugged in.
-

## HP 70340A at a Glance

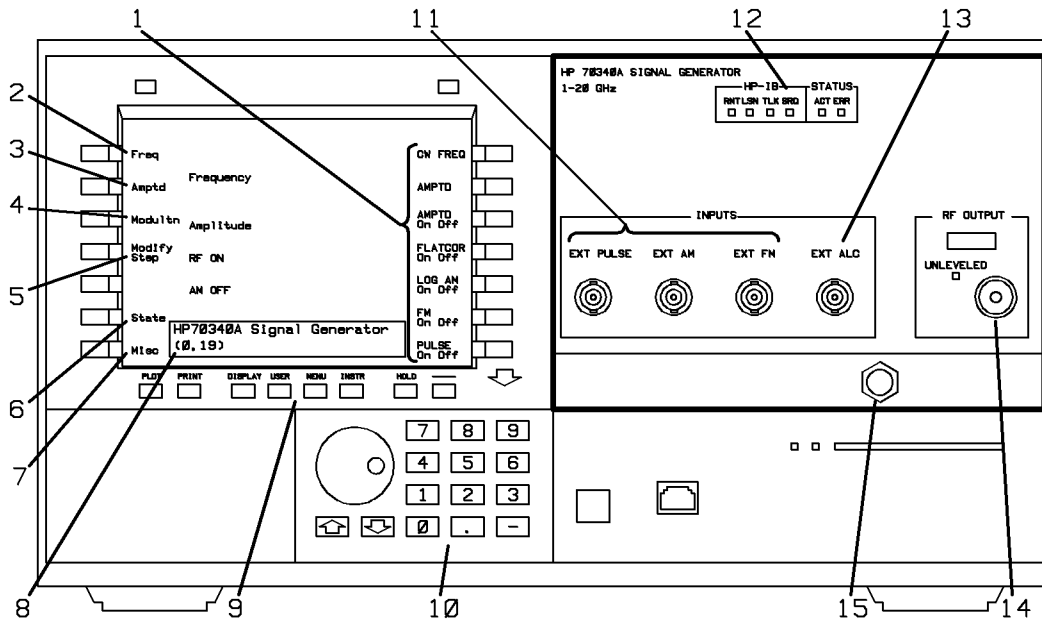

The HP 70340A Modular Signal Generator

## The HP 70340A and HP 70341A



The HP 70340A modular signal generator provides FM, Logarithmic AM, and Pulse modulation capability. The carrier frequency range is from 1 GHz to 20 GHz. The HP 70341A frequency extension module provides 0.01 to 1 GHz frequency range to the signal generator, and thus, the frequency range of the HP 70340A/41A combination is from 0.01 to 20 GHz. With specified leveled output power of greater than +8 dBm and high level accuracy over frequency, power level and temperature, the HP 70340A and HP 70341A have the power and flexibility to meet automatic test needs. Additional specification and options information for both the HP 70340A and the HP 70341A is in the chapter, "Specifications and Options".

1. Functions and submenus appear on the right-hand side of the display during front panel operation. **Functions** turn HP 70340A/41A features on and off and/or allow data entry. **Submenus** access groups of related functions. The functions and submenus that are available change according to the selected main menu.

2. The **Frequency menu** is used to select the CW frequency and the frequency multiplier value of the RF output signal. When this main menu is underscored, the frequency functions are accessible on the right-hand side of the display.

3. The **Amplitude menu** is used to set the output power level and to choose the method of RF output signal leveling. Either internal leveling, external power meter leveling, or external diode detector leveling can be selected. When this main menu is underscored, the amplitude functions are accessible on the right-hand side of the display.

4. The **Modulation menu** is used to select modulation type (FM, Log AM, and pulse modulation) and enter or modify associated data. When this main menu is underscored, the modulation functions are accessible on the right-hand side of the display.



5. The **Modify Step menu** lets you change the knob increment value or the   keys step size. When this main menu is underscored, the modify step functions are accessible on the right-hand side of the display.

6. The **State menu** is used to save/recall most of the HP 70340A/41A operating parameters to/from any of nine nonvolatile register locations. When this main menu is underscored, the state functions are accessible on the right-hand side of the display.

7. The **Miscellaneous menu** accesses HP 70340A/41A features (such as service functions) which are less frequently used. When this main menu is underscored, its associated functions are accessible on the right-hand side of the display.

8. The **data entry box** indicates the current active parameter, if any, and its value. As you enter or modify data, changes are reflected in this box.

9. The **display keys** allow you to perform many display oriented functions. Two important functions of these keys are: choosing/customizing the front panel and accessing error messages.

10. The **data entry keys** are used to enter and modify function parameters. The   keys are used to increase or decrease a parameter in user defined steps. The knob is used to increase or decrease a parameter in decimal steps.

11. The **modulation inputs** (EXT PULSE, EXT AM, and EXT FM) provide BNC connections for external modulating signals. The signal generator RF output can be modulated with any combination of **logarithmic AM, FM and pulse modulation**. With Option 1E2, the **PULSE/TRIG, GATE IN** connector is also used as a trigger/gate input for certain internal pulse modulation modes.

12. The **HP-IB LEDs** (RMT, LSN, TLK, and SRQ) indicate the status of the instrument when it operates over the bus. The **Status LEDs** are ACT and ERR. The ACT LED lights when the signal generator address is selected in the address map, when the instrument is linked to the display keyboard, or when errors are being reported. The ERR LED lights when an error condition exists.

13. The external **Automatic Level Control** voltage (EXT ALC) connector is used as the feedback path to the signal generator when RF output power is leveled externally.

14. The type N (standard) or APC-3.5mm (Option 1E9) **RF OUTPUT** connector is the signal generator RF output. The UNLEVELED LED indicates whether or not output power is leveled.

15. The **Hex Nut Latch** allows easy installation/removal of the signal generator module into/from the Modular Measurement System mainframe.



As shown on the previous page, the full screen mode of the HP 70004A color display module is used to illustrate the various display and signal generator “front panel” menus that you use during front panel (manual) operation.

If you are using a display other than the HP 70004A, your display hardkey names may differ from those in the text of this book. For example, the HP 70004A instrument preset function key is labeled “INSTR PRESET”. On the other hand, some other displays label the same preset function key “I-P”. Wherever key labels differ among mainframes/displays, the HP 70004A label is given followed by an alternate label in parenthesis. For instance, the INSTRUMENT PRESET key is written as **INSTR PRESET** (**I-P**).

Other text conventions used in this book follow:

- signal generator refers to the HP 70340A , alone, or the HP 70340A and HP 70341A
- MMS refers to the HP 70000 Modular Measurement System
- mainframe refers to your mainframe or display (HP 70004A, HP 70205A, or HP 70206A)
- hard key** refers to keys dedicated to one function as labeled. Depending upon the display that you use, your hard key names may differ from those used in this book.
- softkey** refers to keys which change function according to the label on the display screen. Depending upon the display and screen mode that you use, your softkey names may differ from those used in this book.
- screen text** refers to text (other than softkey labels) that is shown on the display screen

The front panel functions, programming commands, procedures, and examples in this book are valid whether or not the HP 70341A is installed in the MMS. In the figure below, the HP 70340A and HP 70341A are shown installed with the HP 70205A display in a single mainframe. Refer to the *HP 70341A Installation Guide* for the frequency extension module installation procedures.

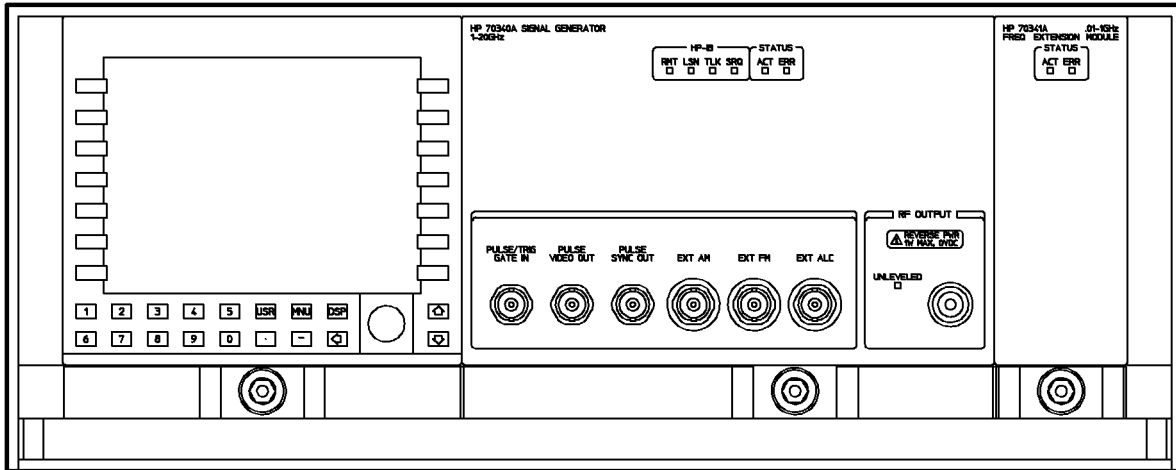

**The HP 70340A Signal Generator and HP 70341A Frequency Extension**

The HP 70340A rear panel features are illustrated and described in detail in the “Front and Rear Panel” chapter of this book. The HP 70341A rear panel and the HP 70340A/41A rear panel connections are shown in the *HP 70341A Installation Guide*.

---

## In This Book

The “OPERATION” section of the *HP 70340A/41A User’s Guide* provides **step-by-step instructions** for many **tasks** that you perform with the HP 70340A and HP 70341A. The following chapters are included in “OPERATION”:

Chapter 1, “Installing and Verifying the Signal Generator”, contains procedures for HP 70340A installation and HP 70340A/41A incoming inspection or functional verification.

Chapter 2, “Performing Fundamental Operations”, familiarizes you with basic operation of the HP 70340A/41A within the MMS environment.

Chapter 3, “Generating Signals”, shows you how to generate various signals using log AM, FM, and pulse modulation and how to level signals.

The “REFERENCE” section of the *HP 70340A/41A User’s Guide* provides information about **instrument features and functions**. The “REFERENCE” section contains these chapters:

Chapter 4, “Specifications and Options” includes HP 70340A and HP 70341A hard specifications, characteristics, and options.

Chapter 5, “Signal Generator Menus and Functions”, describes all HP 70340A/41A softkeys, organized by menus with associated functions listed alphabetically.

Chapter 6, “Display Functions”, lists major display keys and features.

Chapter 7, “Programming Commands”, is a reference of all of the programming commands that the HP 70340A recognizes.

Chapter 8, “Error Messages”, contains the error messages which flag HP 70340A/41A operation errors, and explains recovery actions for each.

Chapter 9, “Front and Rear Panel”, includes hardware related to the HP 70340A and the MMS such as LEDs, switches, and accessories.

Chapter 10, “Legal and Regulatory Information”, contains safety, RFI type acceptance, SCPI conformance, and product warranty information.

# Contents

---

|   |      |
|---|------|
| <b>1. Installing and Verifying the Signal Generator</b>     |      |
| Installing the HP 70340A . . . . .                          | 1-2  |
| To Unpack the HP 70340A . . . . .                           | 1-2  |
| To Install the HP 70340A . . . . .                          | 1-3  |
| To Power-On the HP 70340A . . . . .                         | 1-5  |
| Verifying HP 70340A/41A Functionality . . . . .             | 1-7  |
| To Perform the Self Test . . . . .                          | 1-7  |
| If You Encounter a Problem . . . . .                        | 1-8  |
| Mechanical Damage . . . . .                                 | 1-8  |
| Power-up Problems . . . . .                                 | 1-8  |
| Self Test Failures . . . . .                                | 1-9  |
| <b>2. Performing Fundamental Operations</b>                 |      |
| To Use the Menus . . . . .                                  | 2-2  |
| To Enter Data with the Numeric Keypad . . . . .             | 2-3  |
| To Modify Data with the Knob . . . . .                      | 2-4  |
| To Modify Data with the Arrow Keys . . . . .                | 2-6  |
| To Save and Recall States . . . . .                         | 2-8  |
| Programming Example . . . . .                               | 2-8  |
| To Set the HP 70340A HP-IB Address . . . . .                | 2-9  |
| Programming Example . . . . .                               | 2-9  |
| To Set the HP 70340A HP-MSIB Address . . . . .              | 2-10 |
| To Check the Error Queue . . . . .                          | 2-12 |
| If You Encounter a Problem . . . . .                        | 2-13 |
| <b>3. Generating Signals</b>                                |      |
| To Generate a CW Signal . . . . .                           | 3-2  |
| Programming Example . . . . .                               | 3-3  |
| To Generate an AC FM Signal . . . . .                       | 3-4  |
| Programming Example . . . . .                               | 3-5  |
| To Generate a Power Sweep . . . . .                         | 3-6  |
| Programming Example . . . . .                               | 3-8  |
| To Generate Internal Pulse Modulation . . . . .             | 3-9  |
| Programming Example . . . . .                               | 3-10 |
| Related Tasks . . . . .                                     | 3-11 |
| To Generate Externally Triggered Pulse Modulation . . . . . | 3-12 |
| Programming Example . . . . .                               | 3-14 |
| Related Tasks . . . . .                                     | 3-14 |
| To Generate External Pulse Modulation . . . . .             | 3-15 |
| Programming Example . . . . .                               | 3-16 |
| Related Tasks . . . . .                                     | 3-17 |
| To Generate a Doublet Pulse . . . . .                       | 3-18 |

|  |      |
|--|------|
| Programming Example . . . . .                                  | 3-20 |
| Related Tasks . . . . .  | 3-20 |
| To Generate Gated Pulse Modulation . . . . .                   | 3-21 |
| Programming Example . . . . .                                  | 3-23 |
| Related Tasks . . . . .  | 3-23 |
| To Generate Millimeter Signals . . . . .                       | 3-24 |
| Related Tasks . . . . .  | 3-26 |
| To Use External Diode Detector Leveling . . . . .              | 3-27 |
| Related Tasks . . . . .  | 3-28 |
| To Use External Power Meter Leveling . . . . .                 | 3-29 |
| Programming Example . . . . .                                  | 3-30 |
| Related Tasks . . . . .  | 3-31 |
| To Generate Simultaneous Log AM and Pulse Modulation . . . . . | 3-32 |
| Programming Example . . . . .                                  | 3-34 |
| Related Tasks . . . . .  | 3-34 |
| To Use the Flatness Correction Routine . . . . .               | 3-35 |
| Programming Example . . . . .                                  | 3-38 |
| Related Tasks . . . . .  | 3-39 |
| To Use Previously Stored Flatness Correction Data . . . . .    | 3-40 |
| Programming Example . . . . .                                  | 3-40 |
| Related Tasks . . . . .  | 3-40 |
| If You Encounter a Problem . . . . .                           | 3-41 |

**4. Specifications and Options**

|   |      |
|---|------|
| HP 70340A and HP 70341A Specifications . . . . .                    | 4-2  |
| Frequency . . . . .   | 4-2  |
| RF Output . . . . .   | 4-3  |
| Spectral Purity . . . . .   | 4-4  |
| Modulation . . . . .  | 4-7  |
| General . . . . .   | 4-10 |
| Physical Dimensions . . . . .                                       | 4-11 |
| Rear Panel Connectors . . . . .                                     | 4-12 |
| HP 70340A . . . . .   | 4-12 |
| HP 70341A . . . . .   | 4-13 |
| Options . . . . .   | 4-14 |
| Warranty Options . . . . .  | 4-14 |
| Option W30 - Two Years Additional Return to HP Service . . . . .    | 4-14 |
| Option W32 - Three Years Return to HP Calibration Service . . . . . | 4-14 |
| Option W34 - Three Year Mil-std Calibration Service . . . . .       | 4-14 |
| Documentation Options . . . . .                                     | 4-15 |
| Option 0B2 - Extra User Documentation . . . . .                     | 4-15 |
| Option 0BW - Add Assembly-level Service Documentation . . . . .     | 4-15 |
| Option 0BV - Add Component-level Service Documentation . . . . .    | 4-15 |

## 5. Signal Generator Menus and Functions

|  |      |
|--|------|
| <b>Freq</b>                              | 5-2  |
| <b>CW FREQ</b>                           | 5-3  |
| Data Entry                               | 5-3  |
| Equivalent SCPI Command                  | 5-3  |
| See Also                                 | 5-3  |
| <b>FREQ MULT</b>                         | 5-4  |
| Applications                             | 5-4  |
| Data Entry                               | 5-4  |
| Equivalent SCPI Command                  | 5-5  |
| See Also                                 | 5-5  |
| <b>Amptd</b>                             | 5-6  |
| <b>ALC DIODE</b>                         | 5-7  |
| External Diode Detector Leveling         | 5-7  |
| Applications                             | 5-8  |
| Advantages of Diode Detector Leveling    | 5-8  |
| Disadvantages of Diode Detector Leveling | 5-8  |
| Equivalent SCPI Command                  | 5-8  |
| See Also                                 | 5-8  |
| <b>ALC INT</b>                           | 5-9  |
| Advantages of Internal Leveling          | 5-9  |
| Disadvantages of Internal Leveling       | 5-10 |
| Equivalent SCPI Commands                 | 5-10 |
| See Also                                 | 5-10 |
| <b>ALC PWR MTR</b>                       | 5-11 |
| External Power Meter Leveling            | 5-11 |
| Applications                             | 5-12 |
| External Equipment Limitations           | 5-12 |
| Advantages of Power Meter Leveling       | 5-12 |
| Disadvantages of Power Meter Leveling    | 5-12 |
| Equivalent SCPI Commands                 | 5-13 |
| See Also                                 | 5-14 |
| <b>AMPTD</b>                             | 5-15 |
| Data Entry                               | 5-15 |
| Equivalent SCPI Command                  | 5-15 |
| See Also                                 | 5-16 |
| <b>AMPTD On Off</b>                      | 5-17 |
| Equivalent SCPI Command                  | 5-17 |
| See Also                                 | 5-17 |
| <b>CALIB FLATCOR</b>                     | 5-18 |
| Equivalent SCPI Command                  | 5-19 |
| See Also                                 | 5-19 |
| <b>FLATCOR On Off</b>                    | 5-20 |
| Equivalent SCPI Command                  | 5-20 |
| See Also                                 | 5-21 |
| <b>flatnes corrctn</b>                   | 5-22 |
| <b>FLATNES DATA x</b>                    | 5-23 |
| Equivalent SCPI Command                  | 5-23 |
| See Also                                 | 5-23 |
| <b>HP xxx</b>                            | 5-24 |

|                                     |      |
|-------------------------------------|------|
| See Also . . . . .                  | 5-24 |
| <b>POINTS</b> . . . . .             | 5-25 |
| Equivalent SCPI Command . . . . .   | 5-25 |
| See Also . . . . .                  | 5-26 |
| <b>power meter</b> . . . . .        | 5-27 |
| See Also . . . . .                  | 5-27 |
| <b>PWR MTR ADDRESS</b> . . . . .    | 5-28 |
| Equivalent SCPI Command . . . . .   | 5-28 |
| See Also . . . . .                  | 5-28 |
| <b>PWR MTR READING</b> . . . . .    | 5-29 |
| See Also . . . . .                  | 5-29 |
| <b>SCPI PWR MTR</b> . . . . .       | 5-30 |
| See Also . . . . .                  | 5-30 |
| <b>START FREQ</b> . . . . .         | 5-31 |
| Equivalent SCPI Command . . . . .   | 5-31 |
| See Also . . . . .                  | 5-32 |
| <b>STOP FREQ</b> . . . . .          | 5-33 |
| Equivalent SCPI Command . . . . .   | 5-33 |
| See Also . . . . .                  | 5-34 |
| <b>Modultn</b> . . . . .            | 5-36 |
| FM Sensitivity . . . . .            | 5-37 |
| Equivalent SCPI Command . . . . .   | 5-38 |
| <b>DOUBLET PULSE</b> . . . . .      | 5-39 |
| Doublet Pulse Mode . . . . .        | 5-39 |
| Equivalent SCPI Commands . . . . .  | 5-39 |
| See Also . . . . .                  | 5-39 |
| <b>EXTERN INVERT</b> . . . . .      | 5-40 |
| Equivalent SCPI Command . . . . .   | 5-40 |
| See Also . . . . .                  | 5-41 |
| <b>EXTERN NORMAL</b> . . . . .      | 5-42 |
| Equivalent SCPI Command . . . . .   | 5-42 |
| See Also . . . . .                  | 5-43 |
| <b>FM On Off</b> . . . . .          | 5-44 |
| Equivalent SCPI Command . . . . .   | 5-44 |
| See Also . . . . .                  | 5-44 |
| <b>GATED PULSE</b> . . . . .        | 5-45 |
| Internal Gated Pulse Mode . . . . . | 5-45 |
| Equivalent SCPI Commands . . . . .  | 5-45 |
| See Also . . . . .                  | 5-46 |
| <b>INTERN PULSE</b> . . . . .       | 5-47 |
| Equivalent SCPI Commands . . . . .  | 5-47 |
| See Also . . . . .                  | 5-48 |
| <b>LOG AM On Off</b> . . . . .      | 5-49 |
| Equivalent SCPI Command . . . . .   | 5-49 |
| See Also . . . . .                  | 5-50 |
| <b>PRF</b> . . . . .                | 5-51 |
| Equivalent SCPI Command . . . . .   | 5-52 |
| See Also . . . . .                  | 5-52 |
| <b>PRI</b> . . . . .                | 5-53 |
| Equivalent SCPI Command . . . . .   | 5-54 |

|   |      |
|---|------|
| See Also . . . . .                        | 5-54 |
| <b>PULSE DELAY</b> . . . . .              | 5-55 |
| Positive/Negative Delay . . . . .         | 5-55 |
| Equivalent SCPI Command . . . . .         | 5-55 |
| See Also . . . . .                        | 5-55 |
| <b>pulse modultn</b> . . . . .            | 5-56 |
| <b>PULSE NML INV</b> . . . . .            | 5-57 |
| Equivalent SCPI Commands . . . . .        | 5-57 |
| See Also . . . . .                        | 5-58 |
| <b>PULSE OFF</b> . . . . .                | 5-59 |
| Equivalent SCPI Command . . . . .         | 5-59 |
| See Also . . . . .                        | 5-60 |
| <b>PULSE On Off</b> . . . . .             | 5-61 |
| Equivalent SCPI Command . . . . .         | 5-61 |
| See Also . . . . .                        | 5-62 |
| <b>PULSE WIDTH</b> . . . . .              | 5-63 |
| Equivalent SCPI Command . . . . .         | 5-63 |
| See Also . . . . .                        | 5-63 |
| <b>TRIGGER PULSE</b> . . . . .            | 5-64 |
| Equivalent SCPI Commands . . . . .        | 5-64 |
| See Also . . . . .                        | 5-64 |
| <b>Modify Step</b> . . . . .              | 5-66 |
| <b>INCR SET</b> . . . . .                 | 5-67 |
| Equivalent SCPI Commands . . . . .        | 5-67 |
| See Also . . . . .                        | 5-68 |
| <b>KNOB &lt;--, KNOB --&gt;</b> . . . . . | 5-69 |
| See Also . . . . .                        | 5-69 |
| <b>State</b> . . . . .                    | 5-70 |
| <b>CLEAR STATES</b> . . . . .             | 5-71 |
| See Also . . . . .                        | 5-71 |
| <b>RECALL STATE</b> . . . . .             | 5-72 |
| Equivalent SCPI Command . . . . .         | 5-72 |
| See Also . . . . .                        | 5-72 |
| <b>SAVE STATE</b> . . . . .               | 5-73 |
| Equivalent SCPI Command . . . . .         | 5-73 |
| See Also . . . . .                        | 5-74 |
| <b>Misc</b> . . . . .                     | 5-76 |
| <b>ATTEN AutoHld</b> . . . . .            | 5-76 |
| Applications . . . . .                    | 5-77 |
| Advantages . . . . .                      | 5-77 |
| Disadvantages . . . . .                   | 5-77 |
| Equivalent SCPI Command . . . . .         | 5-77 |
| See Also . . . . .                        | 5-77 |
| <b>CAL YIG OSC</b> . . . . .              | 5-78 |
| Equivalent SCPI Command . . . . .         | 5-78 |
| <b>ENTRY HOLD</b> . . . . .               | 5-79 |
| Application . . . . .                     | 5-79 |
| See Also . . . . .                        | 5-79 |
| <b>ERASE MEMORY</b> . . . . .             | 5-80 |



|  |      |
|--|------|
| Application . . . . .                          | 5-80 |
| Equivalent SCPI Command . . . . .              | 5-80 |
| See Also . . . . .                             | 5-80 |
| <b>FACT COR On Off</b> . . . . .               | 5-81 |
| <b>FM TYPE AC DC</b> . . . . .                 | 5-82 |
| Advantage . . . . .                            | 5-82 |
| Disadvantage . . . . .                         | 5-82 |
| Equivalent SCPI Command . . . . .              | 5-82 |
| See Also . . . . .                             | 5-82 |
| <b>HLD PWR On Off</b> . . . . .                | 5-83 |
| Equivalent SCPI Command . . . . .              | 5-83 |
| See Also . . . . .                             | 5-83 |
| <b>HW CTRL ADDRESS</b> . . . . .               | 5-84 |
| Equivalent SCPI Command . . . . .              | 5-84 |
| See Also . . . . .                             | 5-84 |
| <b>HW CTRL VALUE</b> . . . . .                 | 5-85 |
| Equivalent SCPI Command . . . . .              | 5-85 |
| See Also . . . . .                             | 5-85 |
| <b>LO FREQ</b> . . . . .                       | 5-86 |
| Equivalent SCPI Command . . . . .              | 5-86 |
| See Also . . . . .                             | 5-86 |
| <b>METER NODE</b> . . . . .                    | 5-87 |
| Equivalent SCPI Command . . . . .              | 5-87 |
| See Also . . . . .                             | 5-87 |
| <b>OFFSET FREQ</b> . . . . .                   | 5-88 |
| Equivalent SCPI Command . . . . .              | 5-88 |
| See Also . . . . .                             | 5-88 |
| <b>PWR LIM On Off</b> . . . . .                | 5-89 |
| Application . . . . .                          | 5-89 |
| Pulsed Power Pre-Calibration Program . . . . . | 5-89 |
| Equivalent SCPI Command . . . . .              | 5-91 |
| See Also . . . . .                             | 5-91 |
| <b>RISETME MANAUTO</b> . . . . .               | 5-92 |
| Applications . . . . .                         | 5-92 |
| Equivalent SCPI Command . . . . .              | 5-93 |
| See Also . . . . .                             | 5-93 |
| <b>RISETME xxx</b> . . . . .                   | 5-93 |
| Applications . . . . .                         | 5-93 |
| Equivalent SCPI Command . . . . .              | 5-94 |
| See Also . . . . .                             | 5-94 |
| <b>SELF TEST</b> . . . . .                     | 5-95 |
| Equivalent SCPI Command . . . . .              | 5-96 |
| See Also . . . . .                             | 5-96 |
| <b>service</b> . . . . .                       | 5-97 |
| <b>SHOW INFO</b> . . . . .                     | 5-98 |
| Equivalent SCPI Command . . . . .              | 5-98 |
| See Also . . . . .                             | 5-98 |
| <b>SHOW OPTION</b> . . . . .                   | 5-99 |
| See Also . . . . .                             | 5-99 |

|  |       |
|--|-------|
| <b>TRACE SLAVE</b> . . . . .                     | 5-100 |
| See Also . . . . .                               | 5-100 |
| <b>6. Display Module Functions</b>               |       |
| ↑ and ↓ (Arrow Step) Keys . . . . .              | 6-2   |
| Equivalent SCPI Command . . . . .                | 6-2   |
| See Also . . . . .                               | 6-2   |
| ⇐ (Back Space Arrow) Key . . . . .               | 6-3   |
| See Also . . . . .                               | 6-3   |
| 0 through 9, −, and . (Numeric Keypad) . . . . . | 6-4   |
| See Also . . . . .                               | 6-4   |
| DISPLAY (DSP) Key . . . . .                      | 6-5   |
| See Also . . . . .                               | 6-5   |
| HOLD Key . . . . .                               | 6-6   |
| See Also . . . . .                               | 6-6   |
| INSTR PRESET (I-P) Key . . . . .                 | 6-7   |
| Equivalent SCPI Commands . . . . .               | 6-8   |
| See Also . . . . .                               | 6-9   |
| Knob . . . . .                                   | 6-10  |
| See Also . . . . .                               | 6-10  |
| LOCAL (LCL) Key . . . . .                        | 6-11  |
| See Also . . . . .                               | 6-11  |
| MENU (MNU) Key . . . . .                         | 6-12  |
| USER (USR) Key . . . . .                         | 6-13  |
| <b>7. Programming Commands</b>                   |       |
| Command Syntax . . . . .                         | 7-2   |
| Equivalent SCPI for the HP 8673 Series . . . . . | 7-3   |
| [SOURCE[1]:]POWER:ALC:PMETER . . . . .           | 7-11  |
| Query Syntax . . . . .                           | 7-11  |
| See Also . . . . .                               | 7-12  |
| [SOURCE[1]:]POWER:ALC:PMETER:STEP . . . . .      | 7-13  |
| Query Syntax . . . . .                           | 7-13  |
| See Also . . . . .                               | 7-14  |
| [SOURCE[1]:]POWER:ALC:SOURCE . . . . .           | 7-15  |
| Query Syntax . . . . .                           | 7-15  |
| See Also . . . . .                               | 7-15  |
| [SOURCE[1]:]FREQUENCY[:CW]:FIXED] . . . . .      | 7-16  |
| Query Syntax . . . . .                           | 7-16  |
| See Also . . . . .                               | 7-17  |
| [SOURCE[1]:]FREQUENCY[:CW]:FIXED]:STEP . . . . . | 7-18  |
| Query Syntax . . . . .                           | 7-18  |
| See Also . . . . .                               | 7-19  |
| [SOURCE[1]:]FREQUENCY:MULTIPLIER . . . . .       | 7-20  |
| Query Syntax . . . . .                           | 7-21  |
| See Also . . . . .                               | 7-21  |
| [SOURCE[1]:]FREQUENCY:MULTIPLIER:STEP . . . . .  | 7-22  |
| Query Syntax . . . . .                           | 7-22  |
| See Also . . . . .                               | 7-22  |
| *IDN? (Identification Query) . . . . .           | 7-23  |
| *OPT? (Option Identification Query) . . . . .    | 7-24  |

|   |      |
|---|------|
| OUTPut:IMPedance? . . . . .                     | 7-25 |
| [SOURce[1]:]ROSCillator:SOURce? . . . . .       | 7-26 |
| See Also . . . . .                              | 7-26 |
| SYSTem:ERRor? . . . . .                         | 7-27 |
| See Also . . . . .                              | 7-27 |
| SYSTem:VERsion? . . . . .                       | 7-28 |
| *TST? (Self-Test Query) . . . . .               | 7-29 |
| *LRN? (Learn Device Setup Query) . . . . .      | 7-30 |
| See Also . . . . .                              | 7-31 |
| MEMory:RAM:INITialize . . . . .                 | 7-32 |
| See Also . . . . .                              | 7-32 |
| *RCL (Recall Command) . . . . .                 | 7-33 |
| See Also . . . . .                              | 7-33 |
| *RST (Reset Command) . . . . .                  | 7-34 |
| See Also . . . . .                              | 7-34 |
| *SAV (Save Command) . . . . .                   | 7-35 |
| See Also . . . . .                              | 7-35 |
| SYSTem:PRESet . . . . .                         | 7-36 |
| See Also . . . . .                              | 7-36 |
| MEMory:TABLE:FREQUency . . . . .                | 7-38 |
| Query Syntax . . . . .                          | 7-38 |
| See Also . . . . .                              | 7-40 |
| MEMory:TABLE:FREQUency:POINts? . . . . .        | 7-41 |
| See Also . . . . .                              | 7-41 |
| MEMory:TABLE:LOSS[:MAGNitude] . . . . .         | 7-42 |
| Query Syntax . . . . .                          | 7-42 |
| See Also . . . . .                              | 7-44 |
| MEMory:TABLE:LOSS[:MAGNitude]:POINts? . . . . . | 7-45 |
| See Also . . . . .                              | 7-45 |
| MEMory:TABLE:SELEct . . . . .                   | 7-46 |
| Query Syntax . . . . .                          | 7-46 |
| See Also . . . . .                              | 7-46 |
| [SOURce[1]:]CORREction:CSET[:SELEct] . . . . .  | 7-47 |
| Query Syntax . . . . .                          | 7-47 |
| See Also . . . . .                              | 7-47 |
| [SOURce[1]:]CORREction:CSET:STATe . . . . .     | 7-48 |
| Query Syntax . . . . .                          | 7-48 |
| See Also . . . . .                              | 7-48 |
| [SOURce[1]:]CORREction[:STATe] . . . . .        | 7-49 |
| Query Syntax . . . . .                          | 7-49 |
| See Also . . . . .                              | 7-49 |
| SYSTem:COMMunicate:PMETer:ADDRes . . . . .      | 7-50 |
| Query Syntax . . . . .                          | 7-50 |
| See Also . . . . .                              | 7-50 |
| *DMC (Define Macro Command) . . . . .           | 7-51 |
| See Also . . . . .                              | 7-51 |
| *EMC (Enable Macros) . . . . .                  | 7-52 |
| Query Syntax . . . . .                          | 7-52 |
| See Also . . . . .                              | 7-52 |
| *GMC? (Get Macro Contents Query) . . . . .      | 7-53 |
| See Also . . . . .                              | 7-53 |

|                                    |      |
|------------------------------------|------|
| *LMC? (List Macro Query)           | 7-54 |
| See Also                           | 7-54 |
| *PMC (Purge Macros Command)        | 7-55 |
| See Also                           | 7-55 |
| *RMC (Remove Macro Command)        | 7-56 |
| See Also                           | 7-56 |
| DISPlay[:WINDow][:STATe]           | 7-58 |
| Query Syntax                       | 7-58 |
| ABORt                              | 7-58 |
| See Also                           | 7-58 |
| INITiate:CONTinuous                | 7-59 |
| Query Syntax                       | 7-59 |
| See Also                           | 7-59 |
| [SOURce[1]:]AM:STATe               | 7-60 |
| Query Syntax                       | 7-60 |
| See Also                           | 7-60 |
| [SOURce[1]:]AM:TYPE                | 7-61 |
| Query Syntax                       | 7-61 |
| See Also                           | 7-61 |
| [SOURce[1]:]FM:COUPling            | 7-62 |
| Advantages of DC FM                | 7-62 |
| Disadvantages of DC FM             | 7-62 |
| Query Syntax                       | 7-62 |
| See Also                           | 7-62 |
| [SOURce[1]:]FM:SENSitivity?        | 7-63 |
| See Also                           | 7-63 |
| [SOURce[1]:]FM:STATe               | 7-64 |
| Query Syntax                       | 7-64 |
| See Also                           | 7-64 |
| [SOURce[1]:]MODulation:AOff        | 7-65 |
| See Also                           | 7-66 |
| [SOURce[1]:]MODulation:STATe       | 7-67 |
| Query Syntax                       | 7-67 |
| See Also                           | 7-67 |
| [SOURce[1]:]PULM:EXternal:POLarity | 7-68 |
| Query Syntax                       | 7-68 |
| See Also                           | 7-68 |
| [SOURce[1]:]PULM:SOURce            | 7-69 |
| Query Syntax                       | 7-69 |
| See Also                           | 7-69 |
| [SOURce[1]:]PULM:STATe             | 7-70 |
| Query Syntax                       | 7-70 |
| See Also                           | 7-70 |
| [SOURce[1]:]PULSe:DELAy            | 7-71 |
| Query Syntax                       | 7-71 |
| See Also                           | 7-72 |
| [SOURce[1]:]PULSe:DELAy:STEP       | 7-73 |
| Query Syntax                       | 7-73 |
| See Also                           | 7-74 |
| [SOURce[1]:]PULSe:DOUble[:STATe]   | 7-75 |
| Query Syntax                       | 7-75 |

|  |       |
|--|-------|
| See Also . . . . .   | 7-75  |
| [SOURce[1]:]PULSe:FREQuency . . . . .                      | 7-76  |
| Query Syntax . . . . .                                     | 7-77  |
| See Also . . . . .   | 7-77  |
| [SOURce[1]:]PULSe:FREQuency:STEP . . . . .                 | 7-78  |
| Query Syntax . . . . .                                     | 7-78  |
| See Also . . . . .   | 7-79  |
| [SOURce[1]:]PULSe:PERiod . . . . .                         | 7-80  |
| Query Syntax . . . . .                                     | 7-80  |
| See Also . . . . .   | 7-81  |
| [SOURce[1]:]PULSe:PERiod:STEP . . . . .                    | 7-82  |
| Query Syntax . . . . .                                     | 7-82  |
| See Also . . . . .   | 7-83  |
| [SOURce[1]:]PULSe:TRANsition[:LEADing] . . . . .           | 7-84  |
| Application for Manual Pulse Risettime Selection . . . . . | 7-84  |
| Query Syntax . . . . .                                     | 7-85  |
| See Also . . . . .   | 7-85  |
| [SOURce[1]:]PULSe:TRANsition:STATe . . . . .               | 7-86  |
| Application for Manual Pulse Risettime Selection . . . . . | 7-86  |
| Query Syntax . . . . .                                     | 7-87  |
| See Also . . . . .   | 7-87  |
| [SOURce[1]:]PULSe:WIDTh . . . . .                          | 7-88  |
| Query Syntax . . . . .                                     | 7-88  |
| See Also . . . . .   | 7-89  |
| [SOURce[1]:]PULSe:WIDTh:STEP . . . . .                     | 7-90  |
| Query Syntax . . . . .                                     | 7-90  |
| See Also . . . . .   | 7-91  |
| TRIGger[:SEQUence[1]:]STARt[:SOURce] . . . . .             | 7-92  |
| Query Syntax . . . . .                                     | 7-92  |
| See Also . . . . .   | 7-92  |
| TRIGger[:SEQUence2]:]STOP[:SOURce] . . . . .               | 7-93  |
| Query Syntax . . . . .                                     | 7-93  |
| See Also . . . . .   | 7-93  |
| [SOURce[1]:]POWer[:LEVel] . . . . .                        | 7-95  |
| Query Syntax . . . . .                                     | 7-96  |
| See Also . . . . .   | 7-96  |
| [SOURce[1]:]POWer[:LEVel]:STEP . . . . .                   | 7-97  |
| Query Syntax . . . . .                                     | 7-97  |
| See Also . . . . .   | 7-98  |
| *OPC (Operation Complete) . . . . .                        | 7-100 |
| Query Syntax . . . . .                                     | 7-100 |
| See Also . . . . .   | 7-100 |
| SYSTem:COMMunicate:GPIB:ADDRes . . . . .                   | 7-100 |
| Query Syntax . . . . .                                     | 7-101 |
| See Also . . . . .   | 7-101 |
| SYSTem:COMMunicate:GPIB:ADDRes:STEP . . . . .              | 7-102 |
| Query Syntax . . . . .                                     | 7-102 |
| See Also . . . . .   | 7-102 |
| SYSTem:LANGuage . . . . .                                  | 7-103 |
| Query Syntax . . . . .                                     | 7-103 |
| SYSTem:PTHROugh[:STRing] . . . . .                         | 7-103 |

|  |       |
|--|-------|
| Query Syntax . . . . .                                 | 7-104 |
| See Also . . . . .                                     | 7-104 |
| SYSTEM:PTHRough:ADDRESS . . . . .                      | 7-104 |
| Query Syntax . . . . .                                 | 7-104 |
| See Also . . . . .                                     | 7-104 |
| UNIT:FREQuency . . . . .                               | 7-105 |
| Query Syntax . . . . .                                 | 7-106 |
| UNIT:POWer[:VOLTage] . . . . .                         | 7-107 |
| Query Syntax . . . . .                                 | 7-108 |
| UNIT:TIME . . . . .                                    | 7-109 |
| Query Syntax . . . . .                                 | 7-110 |
| *WAI (Wait-to-Continue Command) . . . . .              | 7-111 |
| See Also . . . . .                                     | 7-111 |
| OUTPut:PROTection[:STATe] . . . . .                    | 7-111 |
| Query Syntax . . . . .                                 | 7-112 |
| See Also . . . . .                                     | 7-112 |
| OUTPut[:STATe] . . . . .                               | 7-113 |
| Query Syntax . . . . .                                 | 7-113 |
| See Also . . . . .                                     | 7-113 |
| [SOURce[1]:]POWer:ATTenuation:AUTO . . . . .           | 7-114 |
| Advantages . . . . .                                   | 7-114 |
| Disadvantages . . . . .                                | 7-114 |
| Query Syntax . . . . .                                 | 7-115 |
| See Also . . . . .                                     | 7-115 |
| [SOURce[1]:]POWer:PROTection:STATe . . . . .           | 7-116 |
| Query Syntax . . . . .                                 | 7-116 |
| See Also . . . . .                                     | 7-116 |
| The Status Register System . . . . .                   | 7-118 |
| General Status Group Model . . . . .                   | 7-118 |
| Condition Register . . . . .                           | 7-119 |
| Negative Transition Register . . . . .                 | 7-119 |
| Positive Transition Register . . . . .                 | 7-119 |
| Event Register . . . . .                               | 7-119 |
| Enable Register . . . . .                              | 7-119 |
| Signal Generator Status Groups . . . . .               | 7-119 |
| The Status Byte Group . . . . .                        | 7-119 |
| The Standard Event Status Group . . . . .              | 7-120 |
| The Standard Operation Status Group . . . . .          | 7-120 |
| The Questionable Data Status Group . . . . .           | 7-121 |
| Status Register System Programming Example . . . . .   | 7-121 |
| *CLS (Clear Status Command) . . . . .                  | 7-123 |
| See Also . . . . .                                     | 7-123 |
| *ESE (Standard Event Status Enable) . . . . .          | 7-124 |
| Query Syntax . . . . .                                 | 7-124 |
| See Also . . . . .                                     | 7-125 |
| *ESR? (Standard Event Status Register Query) . . . . . | 7-126 |
| See Also . . . . .                                     | 7-127 |
| *PSC (Power-On Status Clear) . . . . .                 | 7-128 |
| Query Syntax . . . . .                                 | 7-128 |
| See Also . . . . .                                     | 7-128 |
| *SRE (Service Request Enable) . . . . .                | 7-129 |

|                                 |       |
|---------------------------------|-------|
| Query Syntax . . . . .          | 7-129 |
| See Also . . . . .              | 7-129 |
| STATus:OPERation:CONDition?     | 7-130 |
| See Also . . . . .              | 7-130 |
| STATus:OPERation:ENABle         | 7-131 |
| Query Syntax . . . . .          | 7-132 |
| See Also . . . . .              | 7-132 |
| STATus:OPERation[:EVENT]?       | 7-133 |
| See Also . . . . .              | 7-134 |
| STATus:OPERation:NTRansition    | 7-135 |
| Query Syntax . . . . .          | 7-136 |
| See Also . . . . .              | 7-136 |
| STATus:OPERation:PTRansition    | 7-137 |
| Query Syntax . . . . .          | 7-138 |
| See Also . . . . .              | 7-138 |
| STATus:PRESet                   | 7-139 |
| See Also . . . . .              | 7-139 |
| STATus:QUEStionable:CONDition?  | 7-140 |
| See Also . . . . .              | 7-141 |
| STATus:QUEStionable:ENABle      | 7-142 |
| Query Syntax . . . . .          | 7-143 |
| See Also . . . . .              | 7-144 |
| STATus:QUEStionable[:EVENT]?    | 7-145 |
| See Also . . . . .              | 7-147 |
| STATus:QUEStionable:NTRansition | 7-148 |
| Query Syntax . . . . .          | 7-150 |
| See Also . . . . .              | 7-150 |
| STATus:QUEStionable:PTRansition | 7-151 |
| Query Syntax . . . . .          | 7-153 |
| See Also . . . . .              | 7-153 |
| *STB? (Read Status Byte Query)  | 7-154 |
| See Also . . . . .              | 7-154 |

## 8. Error Messages

|                                 |     |
|---------------------------------|-----|
| Error Messages Format . . . . . | 8-2 |
| Error Messages List . . . . .   | 8-3 |

## 9. Front and Rear Panel

|                                      |     |
|--------------------------------------|-----|
| Accessories (included) . . . . .     | 9-2 |
| Accessories (not included) . . . . . | 9-3 |
| Connectors- HP 70340A Front Panel    | 9-4 |
| EXT ALC . . . . .                    | 9-4 |
| EXT AM . . . . .                     | 9-4 |
| EXT FM . . . . .                     | 9-5 |
| EXT PULSE . . . . .                  | 9-5 |
| RF OUTPUT . . . . .                  | 9-5 |
| PULSE/TRIG, GATE IN . . . . .        | 9-6 |
| PULSE SYNC OUT . . . . .             | 9-6 |
| PULSE VIDEO OUT . . . . .            | 9-7 |
| Connectors- HP 70340A Rear Panel     | 9-8 |
| 0.5-1 GHz Output . . . . .           | 9-8 |

|   |      |
|---|------|
| 0.01-1 GHz Input . . . . .                              | 9-8  |
| 10 MHz INPUT . . . . .                                  | 9-8  |
| 10 MHz OUTPUT . . . . .                                 | 9-8  |
| 0.5 V/GHz OUT . . . . .                                 | 9-9  |
| PULSE OUTPUTS . . . . .                                 | 9-9  |
| EXT ALC OUTPUT . . . . .                                | 9-9  |
| ALC CONTROL OUTPUT . . . . .                            | 9-9  |
| AM OUTPUT . . . . .                                     | 9-9  |
| HP-MSIB Connector (mainframe) . . . . .                 | 9-9  |
| HP-IB Connector . . . . .                               | 9-9  |
| Mainframe/Module Interconnect . . . . .                 | 9-11 |
| See Also . . . . .                                      | 9-11 |
| Electrostatic Discharge Information . . . . .           | 9-12 |
| Reducing Damage Caused By ESD . . . . .                 | 9-12 |
| PC Board Assemblies and Electronic Components . . . . . | 9-12 |
| Test Equipment . . . . .                                | 9-12 |
| Static-Safe Accessories . . . . .                       | 9-13 |
| Fuse . . . . .  | 9-14 |
| See Also . . . . .                                      | 9-14 |
| LEDs- HP 70340A and HP 70341A . . . . .                 | 9-15 |
| ACT LED . . . . .                                       | 9-15 |
| ERR LED . . . . .                                       | 9-15 |
| HP-IB LEDs . . . . .                                    | 9-15 |
| See Also . . . . .                                      | 9-16 |
| LSN LED . . . . .                                       | 9-16 |
| RMT LED . . . . .                                       | 9-16 |
| SRQ LED . . . . .                                       | 9-16 |
| STATUS LEDs . . . . .                                   | 9-17 |
| TLK LED . . . . .                                       | 9-17 |
| UNLEVELED LED . . . . .                                 | 9-17 |
| See Also . . . . .                                      | 9-18 |
| LINE Switch . . . . .                                   | 9-19 |
| See Also . . . . .                                      | 9-19 |
| Module Latch . . . . .                                  | 9-20 |
| Power Cable . . . . .                                   | 9-21 |

**10. Legal and Regulatory Information**

|                                  |       |
|----------------------------------|-------|
| Safety Considerations . . . . .  | 10-2  |
| Before Applying Power . . . . .  | 10-2  |
| Safety Earth Ground . . . . .    | 10-2  |
| Safety Symbols . . . . .         | 10-3  |
| SCPI Conformance . . . . .       | 10-4  |
| Warranty . . . . .               | 10-10 |
| CERTIFICATION . . . . .          | 10-10 |
| WARRANTY . . . . .               | 10-11 |
| LIMITATION OF WARRANTY . . . . . | 10-11 |
| EXCLUSIVE REMEDIES . . . . .     | 10-11 |
| ASSISTANCE . . . . .             | 10-11 |
| . . . . .                        | 10-11 |

**Index**



## Figures

---

|  |       |
|--|-------|
| 1-1. HP 70340A Packaging Materials . . . . .                         | 1-3   |
| 1-2. The HP 70340A Address Switches . . . . .                        | 1-4   |
| 1-3. HP 70340A Module Installation . . . . .                         | 1-4   |
| 1-4. Line Fuse Removal and Replacement . . . . .                     | 1-8   |
| 2-1. The HP 70340A Address Switches . . . . .                        | 2-10  |
| 3-1. AC FM Equipment Setup . . . . .                                 | 3-4   |
| 3-2. Log AM Equipment Setup . . . . .                                | 3-6   |
| 3-3. Example Sawtooth Waveform . . . . .                             | 3-7   |
| 3-4. Externally Triggered Pulse Modulation Equipment Setup . . . . . | 3-12  |
| 3-5. Triggered Pulse Mode Timing Example . . . . .                   | 3-14  |
| 3-6. External Pulse Modulation Equipment Setup . . . . .             | 3-15  |
| 3-7. Doublet Pulse Equipment Setup . . . . .                         | 3-18  |
| 3-8. Doublet Pulse Mode Timing Example . . . . .                     | 3-19  |
| 3-9. Gated Pulse Modulation Equipment Setup . . . . .                | 3-21  |
| 3-10. Gated Pulse Mode Timing Example . . . . .                      | 3-23  |
| 3-11. Millimeter Wave Equipment Setup . . . . .                      | 3-24  |
| 3-12. External Diode Detector Leveling Setup . . . . .               | 3-27  |
| 3-13. External Power Meter Leveling Setup . . . . .                  | 3-29  |
| 3-14. Antenna Scan Equipment Setup . . . . .                         | 3-32  |
| 3-15. Example Antenna Scan Input . . . . .                           | 3-33  |
| 3-16. Example Modulated Antenna Scan Pattern . . . . .               | 3-34  |
| 3-17. Flatness Correction Equipment Setup . . . . .                  | 3-36  |
| 5-1. Frequency Menu Structure . . . . .                              | 5-2   |
| 5-2. Amplitude Menu Structure . . . . .                              | 5-6   |
| 5-3. External Diode Leveling Set-up . . . . .                        | 5-7   |
| 5-4. External Power Meter Leveling Set-up . . . . .                  | 5-11  |
| 5-5. Modulation Menu Structure . . . . .                             | 5-36  |
| 5-6. Modulation Menu Structure- Option 1E2 . . . . .                 | 5-37  |
| 5-7. Doublet Pulse Mode Timing . . . . .                             | 5-39  |
| 5-8. Internal Gated Pulse Mode Timing . . . . .                      | 5-45  |
| 5-9. Internal Triggered Pulse Mode Timing . . . . .                  | 5-64  |
| 5-10. Modify Step Menu Structure . . . . .                           | 5-66  |
| 5-11. State Menu Structure . . . . .                                 | 5-70  |
| 5-12. Miscellaneous Menu Structure . . . . .                         | 5-76  |
| 6-1. Instrument Preset Full Screen Display . . . . .                 | 6-7   |
| 6-2. <b>MENU</b> Function Full Screen Display . . . . .              | 6-12  |
| 6-3. <b>USER</b> Function Full Screen Display . . . . .              | 6-13  |
| 7-1. Status Register System Hierarchy . . . . .                      | 7-118 |
| 7-2. General Status Group Model . . . . .                            | 7-118 |
| 9-1. HP 70340A Connectors - Front Panel . . . . .                    | 9-4   |
| 9-2. HP 70340A Connectors - Option 1E2 Front Panel . . . . .         | 9-6   |
| 9-3. HP 70340A Connectors - Rear Panel . . . . .                     | 9-8   |

|   |      |
|---|------|
| 9-4. HP-IB Connector and Cable . . . . .                      | 9-10 |
| 9-5. Power Cable and Line (Mains) Plug Part Numbers . . . . . | 9-21 |

## Tables

---

|   |      |
|---|------|
| 7-1. HP 8673 Series SCPI/IEEE Equivalents . . . . . | 7-4  |
| 9-1. Accessories (not included) . . . . .           | 9-3  |
| 9-2. HP-IB Interface Cables . . . . .               | 9-10 |
| 10-1. SCPI Conformance . . . . .                    | 10-5 |

## Installing and Verifying the Signal Generator

---

This chapter contains both the procedures for properly installing your HP 70340A modular signal generator into the MMS and procedures for functional verification of the instrument. Refer to the *HP 70341A Installation Guide* for installation procedures for the HP 70341A.

When the term “mainframe” is used in this chapter, it refers to a mainframe with a display (HP 70004A or HP 70205A) or a stand-alone display (HP 70206A). The verification procedure in this chapter is suitable for a functional verification or incoming inspection of the instrument. However, if you wish to run a full set of incoming inspection tests or test every warranted instrument specification, refer to the *HP 70340A/41A Calibration Guide* or the *HP 70340A Service Guide* for performance tests.

If you have difficulty running any of the procedures in this chapter, “If You Encounter a Problem” lists commonly encountered problems and solutions that allow you to quickly get back to work. This section is located at the end of the chapter.

The only external accessory required for the procedures in this chapter is the Hex ball driver.

---

## Installing the HP 70340A

This procedure explains how to inspect, install, and power-up the HP 70340A. The only tool necessary for this procedure is an 8 mm hex ball driver (HP part number 8710-1307). This tool is included with your MMS mainframe or display.

To install the HP 70341A, refer to the *HP 70341A Installation Guide* that ships with the module.

### To Unpack the HP 70340A

1. **Inspect the shipping container for damage.**
2. **Carefully remove the contents (HP 70340A and accessories) from the shipping container and check each item for damage.**

The following items are included in the shipment:

- HP 70340A modular signal generator
- *HP 70340A/41A User's Guide*
- *HP 70340A/41A Quick Start Guide*
- *HP 70340A/41A Calibration Guide* with Software Disks

If Option 0B2 was ordered, the following extra set of the user documentation is included:

- *HP 70340A/41A User's Guide*
- *HP 70340A/41A Quick Start Guide*
- *HP 70340A/41A Calibration Guide* with Software Disks

If Option 0BW was ordered, a set of assembly-level service documentation is provided along with the user documentation. In addition to the *HP 70340A/41A Calibration Guide* and software, the assembly-level service documentation includes:

- *HP 70340A Service Guide*

If Option 0BV was ordered, a set of component-level service documentation is provided along with the user documentation. The component-level service documentation includes:

- *HP 70340A Component Level Information Manual*

If the instrument appears to be damaged, refer to “Mechanical Damage” in “If You Encounter a Problem” at the end of this chapter.

---

**Note** A power cable is not shipped with the HP 70340A. It is supplied with your MMS mainframe or display. For a list of accessories that are required for certain instrument applications but not included with the instrument, refer to the “Accessories (not included)” entry of the “Front and Rear Panel” chapter.

---

3. **Keep the shipping materials for future use.**

If undamaged, shipping materials are useful for shipment or storage of the instrument. If damaged, shipping materials should be kept for the carrier's inspection.

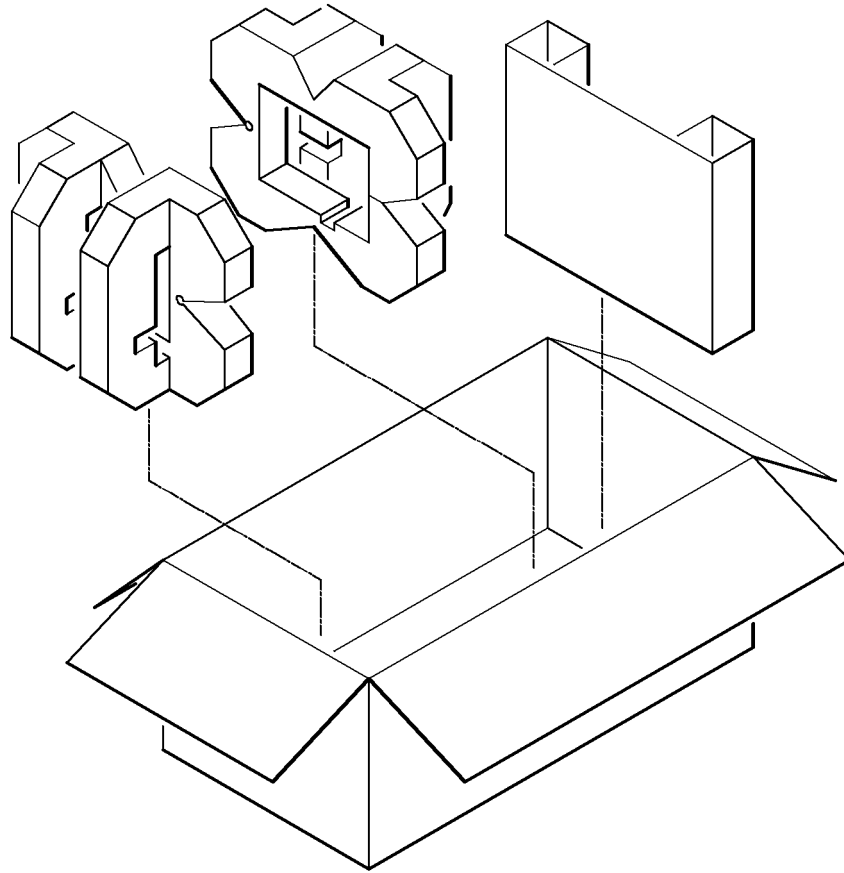

**Figure 1-1. HP 70340A Packaging Materials**

### **To Install the HP 70340A**

The following provides a general procedure for installing the HP 70340A. Because of the many possible MMS configurations, you may need to refer to the system documentation. For instance, many HP 70000 Modular Measurement Systems are shipped in a preconfigured system model. The modules and displays in these preconfigured systems have addresses that are already set when you receive them. If you have a preconfigured system model, refer to the system documentation for information on installation.

If you have an HP 70341A frequency extension module, refer to the *HP 70341A Installation Guide* to install the module, and then, continue with the procedure “Verifying the HP 70340A/41A Functionality” in this chapter.

1. **Before installing the HP 70340A into the MMS mainframe, turn the mainframe off by setting the LINE (Mains) switch to the off position.**

If the system is on when you install the instrument, personal injury or damage to the instrument can occur.

2. **Check that the Line Voltage Selector switch of the mainframe is set to the voltage of your power source.**

The red Line Voltage Selector switch is located on the side or rear panel of the mainframe.

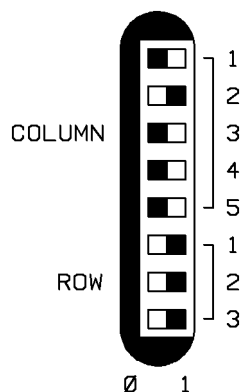

Figure 1-2. The HP 70340A Address Switches

3. Check that the HP 70340A module HP-MSIB address switches are set to the correct address.

The address switches are on the rear panel of the HP 70340A as shown in Figure 1-2. The default HP-MSIB address for the HP 70340A module is row 0 column 29 as shown. To change the HP-MSIB address, refer to the procedure “To Set the HP 70340A HP-MSIB Address” in Chapter 2, “Performing Fundamental Operations.”

---

**Note** The *Display Configuration* address switches on the back of the Graphics Display are for the display instrument only. These switches do *not* set the address of the system or any module within the system.

---

4. Connect the power cable(s) to the system and then to the power source.

---

**Warning** This is a safety Class 1 product (that is, it is provided with a protective earth terminal). An uninterruptible safety earth ground must be provided through the power cable. Whenever it is likely that the ground is impaired, the product must be made inoperative.

---

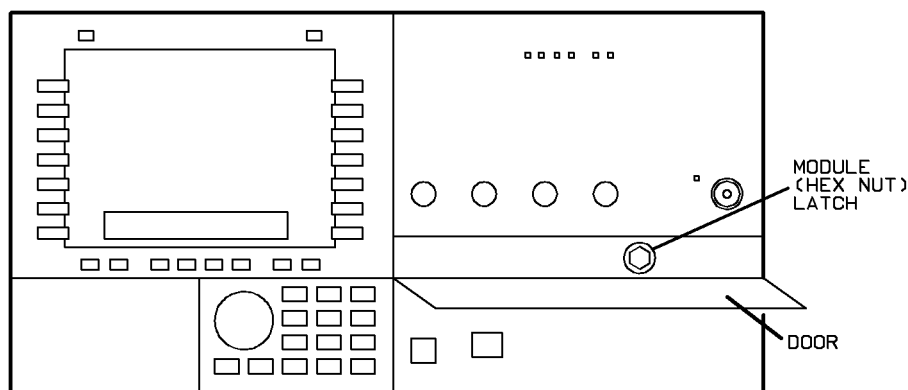

Figure 1-3. HP 70340A Module Installation

5. Swing the mainframe front panel door down.

#### 1-4 Installing and Verifying the Signal Generator

On some MMS mainframe models, the door will not open unless the LINE switch is off (step 1 of this procedure).

**6. Slide the HP 70340A module into the mainframe.**

**7. Tighten the module latch using an 8 mm hex-ball driver.**

The 8 mm hex-ball driver (HP part number 8710-1307) is included with your MMS mainframe or display. It is necessary to use this tool for installation and removal of a module.

**8. Close the mainframe front panel door.**

---

**Note** To remove the HP 70340A from the MMS follow the steps in the procedure, “To Install the HP 70340A,” in reverse order while substituting terms like “tighten” for “loosen.”

---

### To Power-On the HP 70340A

1. Check to make sure that the power cable is undamaged.
2. Set the mainframe LINE (Mains) switch to off.
3. Connect the power cable(s) to the system and then to the power source.
4. Set the mainframe LINE (Mains) switch to ON.

When you turn the MMS on, the power light comes on and the ventilation fan(s) start. (You can feel that the fans are on by placing your hand near the back of the mainframe.) In addition, it is normal for the HP 70340A LEDs (including the **ERR** LED) to turn on and then off during a power-up test. (The **ERR** LED should be off when the power-up test is complete.)

If you have problems with power-up of the HP 70340A, refer to the “Power-Up Problems” section in “If You Encounter a Problem” at the end of this chapter.

**5. Check that the HP 70340A module HP-IB address is correct.**

The default HP-IB address setting is 19.

To check the HP-IB address:

- a. Press the **DISPLAY** (or **DSP**) key on the display.
- b. Select the **Address Map** menu.
- c. Select **ADJUST COLUMN** and turn the Knob clockwise to scroll through the module addresses until you see the following in the highlighted box:

```
-----  
| 70340A      |  
| Signal Gen |  
| HP-IB XX   |  
-----
```

YY

where XX is the current HP-IB address and YY is the HP-MSIB column address

- d. Press the **MENU** key in order to return to the instrument front panel.



To change the HP-IB address, refer to the procedure “To Set the HP 70340A HP-IB Address” in Chapter 2, “Performing Fundamental Operations.”

---

## Verifying HP 70340A/41A Functionality

The functionality of the HP 70340A and the HP 70341A can be verified by following this procedure. To perform a more rigorous incoming inspection or to verify *all* instrument hard specifications, run the full set of performance tests in the *HP 70340A/41A Calibration Guide*.

### To Perform the Self Test

---

**Note** Error codes generated under conditions of environmental stress may or may not indicate a failure of the signal generator circuitry.

---

1. Check the HP 70340A for any pre-existing error conditions.

Error conditions are indicated by either the module's red ERR LED or the display's "E." If the HP 70340A ERR LED is on or the "E" appears on the display, read the error queue messages and resolve any problems before continuing with this procedure. Refer to the procedure, "To Check the Error Queue," in chapter 2. If the HP 70341A ERR LED is on, refer to the service guide.

2. To run the self test routine.

On the HP 70340A:

- a. Select the **Misc** menu on the left-hand side of the display.
- b. Select the **SELF TEST** function on the right-hand side of the display.

While the self test routine is running, the display's data entry box indicates messages like

```
presetting instrument
```

After the test completes (about 1 minute), the display indicates:

```
self test complete
```

or

```
x=y
```

*where x and y are numbers indicating an error condition.*

The self test may create some temporary error conditions that cause the module's ERR LED and the display's "E" to turn on and remain on. This is characteristic of the self test and does not indicate an instrument or system failure. A *true* error condition is indicated only by the x=y display.

3. If the self test indicates a true error condition, refer to the *HP 70340A Service Guide*.

---

## If You Encounter a Problem

If you have a problem while installing or verifying the HP 70340A, check the following list of commonly encountered problems and troubleshooting procedures. If the problem that you encounter is not in the following list, refer to the Troubleshooting section of the *Installation and Verification Manual* for your MMS mainframe, or contact the nearest Hewlett-Packard office for service.

### Mechanical Damage

**If the instrument is mechanically damaged when it is received:**

- Contact the nearest Hewlett-Packard office and the carrier.
- Keep the shipping materials for the carrier's inspection.

### Power-up Problems

**If the power light on the mainframe does not light:**

- Check that the power cord is connected.
- Check that the mainframe fuse is good and the proper value.

Refer to Figure 1-4. The metric 6.3A fuse is HP part number 2110-0703.

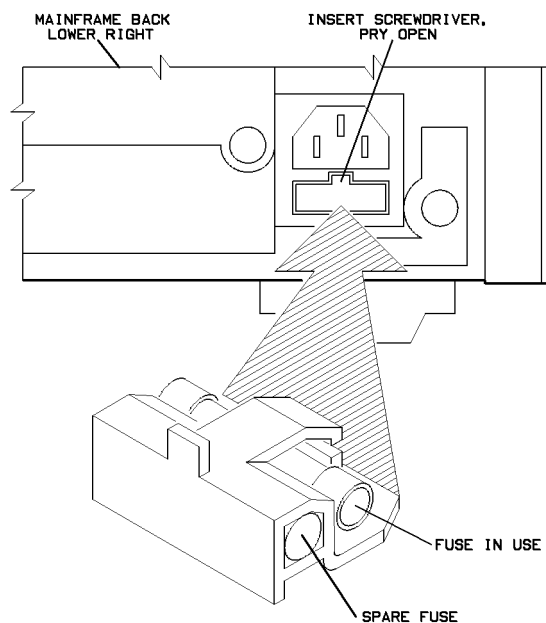

**Figure 1-4. Line Fuse Removal and Replacement**

You can use a continuity light or an ohmmeter to check the fuse. An ohmmeter should read very close to zero ohms if the fuse is good. Visual inspection of the fuse is not a sure check that the fuse is good.

If the fuse is bad, replace it and attempt power-up.

---

**Warning**      **For continued protection against fire hazard, replace the fuse with one that is the same type and rating.**

---

- Remove the HP 70340A module from the MMS and attempt to power-up the mainframe, itself.

If the mainframe power light does not come on, the mainframe is bad. If the mainframe does power-up, the fault lies with the HP 70340A.

**If the mainframe power light is on, but the ventilation fan does not start:**

- Set the mainframe LINE (Mains) switch to OFF.
- Check for blockage of the fan intakes at the bottom rear of the mainframe.
- Refer to your MMS mainframe manual.

---

**Note**            The HP 70004A Display fan is very quiet.

---

**If the HP 70341A ERR LED remains on after the power-up test is complete:**

- Refer to the *HP 70341A Service Guide*, or contact the nearest Hewlett-Packard office for service.

**If the HP 70340A ERR LED or the display E remains on after the power-up test is complete:**

- Check the error queue for error messages.

Refer to the procedure, “To Check the Error Queue” in Chapter 2, “Performing Fundamental Operations.”

- Check that the **ERR** LED or the display E is not flashing.

If any error indicator is flashing at about a 1 Hz rate, that module cannot talk over the HP-MSIB bus.

If more than one error indicator is flashing, the mainframe HP-MSIB is faulty, a module is faulty, or the HP-MSIB cables are probably faulty.

- Check that there are no mainframe error messages.

Mainframe error messages will appear on the display. Refer to your mainframe operating and service manuals if a mainframe error occurs.

- Check for proper (secure) HP-MSIB cable connections.

## Self Test Failures

**If the Self Test Fails:**

- Check that the Error Indicator is not flashing.

The error indicator on the HP 70340A is the **ERR** LED on the instrument front panel.

If the HP 70340A error indicator is flashing at about a 1 Hz rate, it cannot talk over the HP-MSIB bus. If the error indicator on more than one MMS module is flashing, the mainframe HP-MSIB is faulty or the HP-MSIB cables are probably faulty.

- Check that the instrument module hex latch connection is secure (tight).
- Refer to the troubleshooting section of the *HP 70340A Service Guide*.

## Performing Fundamental Operations

---

This chapter describes basic Modular Measurement System, MMS, operations. Its purpose is to quickly familiarize you with the general operation of the HP 70340A and HP 70341A within the MMS. For more detailed information, refer to the display operating manual or the “70000 Protocol and Functional Specifications” document.

Instruments that are part of the MMS have some important differences from stand-alone instruments. MMS instruments are composed of plug-in modules, the power supply is distributed, and the modules communicate with each other using the Modular System Interface Bus, HP-MSIB.

The HP 70340A is a single-module instrument because, when operating in *programming mode*, it needs no other module to complete its task. When operating in *local mode*, however, the HP 70340A module requires the display module for front panel control. The HP 70341A, on the other hand, is a slave module because it adds frequency extension to the HP 70340A, but, provides no function as a single module.

The procedures in this chapter show you how to operate the display and HP 70340A/41A modules together during front panel operation. Procedures include how to use the HP 70340A/41A menus, enter or modify data via the front panel or over the bus, set the HP 70340A HP-IB and HP-MSIB addresses, save and recall instrument states, and read the error queue.

With the signal generator (and frequency extension module) properly installed, the procedures in this chapter require no additional equipment or accessories.

---

## To Use the Menus

When you use the HP 70340A/41A in local mode, the *front panel* menus and functions appear on the display screen. The main menus on the left-hand side of the display do not change. The menus and functions on the right-hand side do change depending upon which menu is selected.

- **Select menus from the left-hand side of the display.**

A menu is underscored when it is selected.

To see which functions are associated with a menu, select the menu, and examine the functions (in uppercase) on the right-hand side of the display. You can also examine the structure of each menu by referring to the appropriate tab (for example, Frequency) in the “Reference” section of this book.

- **Select functions from the right-hand side of the display.**

Functions appear in uppercase letters under main menus or submenus. For example, the `AMPTD` function appears under the `Amptd` main menu.

- **Select submenus from the right-hand side of the display, also.**

Submenus appear in all lowercase letters. Submenus access more functions which are related to the submenu. For example, to access the FLATNESS DATA REGISTER 1 function used for FLATNESS CORRECTION, follow these steps:

1. Select the `Amptd` menu.
2. Select the `flatnes corrctn` menu.
3. Select the `FLATNES DATA 1` function.

- **If you do not see the function that you seek, and there is a MORE 1 OF 2 or MORE 1 of 3 function, selecting it accesses more functions under the current menu.**

For example, to access the FM TYPE AC DC function, follow these steps:

1. Select the `Misc` main menu.
2. Select `MORE 1 of 2` to access the next page of the menu.
3. Select the `FM TYPE AC DC` function to choose between AC or DC FM.

- **If desired, select a main menu softkey on the left-hand side of the display in order to immediately return to the main (top level) menus and functions.**

Alternatively, you can trace your steps back to the top menu level by pressing the `←` as many times as is necessary. (The `←` key is also the backspace key when you enter data in the data entry box.)

---

## To Enter Data with the Numeric Keypad

The display's numeric keypad combined with the units terminator softkeys provide one way to enter function parameters.

### 1. Select a function softkey.

The function must have a numeric value (parameter) associated with it in order to enter new data with the numeric keypad. AMPLITUDE, FREQUENCY MULTIPLIER, and CW FREQUENCY are examples of functions with parameters.

When you select a function that requires numeric data, its key label appears in inverse video (highlighted) and the data entry box at the bottom of the display indicates the function, its current value, and any associated units. For example, if CW frequency is the selected function with a current value of 2 GHz, the data entry box indicates:

```
Frequency
2.000000000GHz
```

### 2. Enter the desired value of the parameter by pressing the numeric keys and, if necessary, the decimal and negative keys.

Notice that, as you press the keys, the display's data entry box shows the numbers.

### 3. Select the appropriate units terminator softkey to enter the value.

The units terminator softkey(s) appear(s) on the right-hand side of the display once you use the numeric keypad. If there are no units associated with a number, use the **ENTER** softkey to enter the typed in value.

The following steps show how to enter a value of -9 dBm for RF output amplitude:

- a. Select the **Amptd** menu which automatically selects **AMPTD** as the active function.
- b. Press **(-)** and then **(9)** on the numeric keypad.
- c. Press the **dBm** softkey to terminate the entry.

Once you terminate the entry, the signal generator updates the amplitude value to -9 dBm.

---

### Note

**CLEAR** always appears as one of the units terminator keys so that you can erase the data that you have entered and return to the previous data.

---



---

## To Modify Data with the Knob

The display's Knob is used to modify data. You turn the Knob in order to increase or decrease the parameter value of the currently active function. Additionally, you can change the Knob resolution in order to increase or decrease the rate at which the function parameter changes.

### 1. Select a function softkey.

The function must have a numeric value (parameter) associated with it in order to enter new data with the numeric keypad. AMPLITUDE and CW FREQUENCY are examples of functions with parameters.

When you select a function that requires numeric data, it appears in inverse video (highlighted) and the data entry box at the bottom of the display indicates the function, its current value, and any associated units. For example, if CW frequency is the selected function with a current value of 2 GHz, the data entry box indicates:

```
Frequency
2.000000000GHz
```

### 2. Turn the Knob clockwise to increase the parameter or counterclockwise to decrease the parameter.

When you turn the Knob, the underscored digit in the data entry box increases or decreases in steps of one.

For example, when CW frequency is in its preset state and is the active parameter, the data entry box shows:

```
Frequency
3.000000000GHz
  _
```

When you turn the Knob in this case, the value of CW frequency changes in MHz steps (ie. 3.001000000, 3.002000000).

### 3. If you wish to change the Knob resolution, select the **Modify Step** menu on the left-hand side of the display.

The Modify Step menu accesses the KNOB --> and KNOB <-- functions which allow you to change the Knob resolution.

### 4. If you wish to decrease the Knob resolution, select the **KNOB -->** softkey.

Selecting **KNOB -->** once moves the decimal position of the underscore to the right one place in order to decrease the Knob resolution by a factor of ten.

### 5. If you wish to increase the Knob resolution, press the **KNOB <--** softkey.

**KNOB <--** moves the decimal position of the underscore to the left one place in order to increase the Knob resolution by a factor of ten.

### 6. Continue to press the **KNOB -->** or **KNOB <--** softkeys until the underscore is positioned at the desired digit.

For example, suppose that CW FREQUENCY is the current active function (select **Freq** in order to activate **CW FREQ**), and you wish to change the resolution from 1 MHz to 1

GHz. (Currently the instrument is in its preset condition.) The steps that follow illustrate how to accomplish this:

The display indicates:

```
Frequency
3.000000000GHz
  |
```

- a. Select the **Modify Step** menu.
- b. Press the **Knob <-->** softkey three times. This moves the underscore from the decimal position corresponding to MHz to the decimal position corresponding to GHz. The display indicates:

```
Frequency
3.000000000GHz
 |
```

- c. Rotate the Knob slowly so that you can see the frequency change in 1 GHz steps.

---

**Note**            The Knob and the Arrow Keys operate independently of each other. The arrow keys increase or decrease the parameter in defined steps.

---

---

## To Modify Data with the Arrow Keys

The display's  $\uparrow$  and  $\downarrow$  (Arrow) Keys increase or decrease the active function's parameter.

### 1. Select a function softkey.

The function must have a numeric value (parameter) associated with it in order to enter new data with the numeric keypad. AMPLITUDE, FREQUENCY MULTIPLIER, and CW FREQUENCY are examples of functions with parameters.

When you select a function that requires numeric data, it appears in inverse video (highlighted) and the data entry box at the bottom of the display indicates the function, its current value, and any associated units. For example, if CW frequency is the selected function with a current value of 2 GHz, the data entry box indicates:

```
Frequency
2.000000000GHz
```

2. Press the  $\uparrow$  key or the  $\downarrow$  key in order to increase or decrease the selected function's parameter, respectively.
3. If you wish to change the arrow keys step value, select the **Modify Step** menu and then the **INCR SET** function.
4. To change the arrow keys step value, enter the desired value in the data entry box using the numeric keypad.
5. Select the appropriate units terminator softkey to enter the value.

The units terminator softkey(s) appear(s) on the right-hand side of the display once you use the numeric keypad. If there are no units associated with a number, you use the **ENTER** softkey to enter the typed in value.

For example, to change the arrow keys step value for AMPTD data to 2 dB, follow these steps:

Currently, the display indicates:

```
Amplitude
XXdBm
where "XX" is the current RF output amplitude
```

- a. Select the **Modify Step** menu.
- b. Select the **INCR SET** function.

Now, the display indicates:

```
Amplitude Increment
YYdB
where YY is the current amplitude Knob resolution
```

- c. Press **2** on the numeric keypad.

The display indicates:

```
Amplitude Increment
2
```

- d. Select the **dB** softkey on the right-hand side of the display in order to terminate the entry.

The display indicates:

```
Amplitude Increment  
2.00dB
```

6. Press the **(←)** key on the display in order to exit the **Modify Step** menu.
7. If it is not already selected, select (highlight) the function of interest, again.
8. Press the **(↑)** key to increase the function's parameter.
9. Press the **(↓)** key to decrease the function's parameter.

---

**Note**            The Knob and the Arrow Keys operate independently of each other. The Knob increases or decreases the underscored digit of the parameter by 1.

---

---

## To Save and Recall States

When you use the signal generator for a specific application, you can save and then recall the instrument state for future use. You can store up to ten different instrument states at a time.

1. **Select the `State` menu.**

The softkey is underscored when it is selected.

2. **Select the `SAVE STATE` softkey if you wish to save the current instrument state, or select the `RECALL STATE` softkey if you wish to recall an instrument state from memory.**

The function appears in inverse video when it is selected. The data entry box indicates:

Save State in Reg

X

*where X is the current register location where the instrument state will be saved.*

or

Recall State from Reg

X

*where X is the register location from which the instrument state will be recalled.*

3. **Use the numeric keypad to enter the desired register location.**

Valid register locations are 0 through 9.

4. **Press the `ENTER` softkey to terminate the entry.**

If you enabled the `SAVE STATE` function, the instrument saves the current instrument state in the register that you selected. Note that any previously stored data in the register is purged when new data is stored.

If you enabled the `RECALL STATE` function, the instrument recalls the instrument state from the register that you selected. If no data has been saved to the register that you specify, the instrument preset state is recalled.

### Programming Example

Use the following commands to store the instrument state to register 9 and then recall it from register 9:

```
OUTPUT 719; "*SAV 9"  Saves the current instrument state to register 9.
OUTPUT 719; "*RCL 9"  Recalls the previously stored instrument state
                      from register 9.
```

---

## To Set the HP 70340A HP-IB Address

The default factory setting of the HP 70340A HP-IB address is 19. You can, however, change this address either by using the display front panel or by sending a SCPI command string over the bus. The procedure for changing the HP-IB address via the front panel is described here.

Note that the HP 70341A does not have an HP-IB address.

1. Press the **DISPLAY** (**DSP**) key on the display.
2. Select the **Address Map** menu.
3. Select **ADJUST COLUMN** and turn the Knob clockwise to scroll through the module addresses until you see the following highlighted box:

```
-----  
| 70340A      |  
| Signal Gen  |  
| HP-IB XX    |  
-----
```

YY

where XX is the current HP-IB address and YY is the current HP-MSIB column address

Note that the default HP-MSIB column address for the instrument is 29 while the default HP-IB address is 19.

4. Select the **HP-IB ADRSSET** softkey.

The softkey is underscored when it is selected, and the display indicates:

```
HPIB ADDRESS:
```

5. Enter the desired HP-IB address using the numeric keypad.
6. Select the **ENTER** softkey to terminate the entry.
7. Press the **MENU** key in order to return to the instrument front panel.

---

**Note** Whether the HP-IB address is changed using the HP-IB ADDRESS function or the SCPI command string, the address is stored in non-volatile memory.

---

## Programming Example

To set the HP 70340A HP-IB address to 12, send the following command:

```
OUTPUT 719; "SYST:COMM:GPIB:ADDR 12" Sets the HP 70340A HP-IB address to 12.
```

---

## To Set the HP 70340A HP-MSIB Address

Each module in the Modular Measurement System must have a unique HP-MSIB address. There are 255 legal addresses which consist of a row and a column address. The address for the HP 70340A is preset at the factory to be Row 0, Column 29. You can, however, change the HP-MSIB address with the address switches on the HP 70340A rear panel.

Refer to the *HP 70341A Installation Guide* for details on how to change the module's HP-MSIB address.

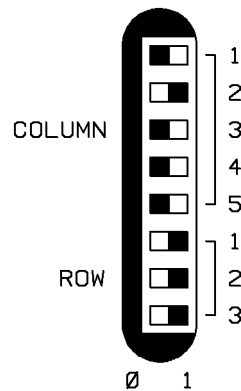

**Figure 2-1. The HP 70340A Address Switches**

Figure 2-1 shows the HP 70340A standard Address Switch Configuration for address (0,29). The switches are located on the rear panel of the signal generator.

---

**Note** Do not confuse the HP 70340A Address Switches with the Display Configuration Switches. The *Display Configuration* address switches on the back of the Graphics Display are for the display instrument only. These switches do *not* set the address of the system or any module within the system.

---

### 1. Set switches Row 1, Row 2, Row 3, to set the row address of the HP 70340A.

Row 0 is the default setting for the signal generator. When a module has a Row 0 address, error reporting and access to HP-IB are allowed.

The row address is in binary where Row 1 is the least significant bit and Row 3 is the most significant bit.

Legal row addresses are 0 through 8. However, the address: Row 0, Column 31, is illegal.

### 2. Set switches Column 1, Column 2, Column 3, Column 4, and Column 5 to set the column address of the HP 70340A.

Column 1 switch determines the least significant bit and Column 5 switch determines the most significant bit. Be certain that the address that you choose is unique among MMS modules. For instance, if you want to set the instrument column address to decimal 19, follow these steps:

- Set Column 1 switch to **on** or **1** position.
- Set Column 2 switch to **on** or **1** position.

## 2-10 Performing Fundamental Operations

- c. Set Column 3 switch to **off** or **0** position.
- d. Set Column 4 switch to **off** or **0** position.
- e. Set Column 5 switch to **on** or **1** position.

This is the binary address “10011” which converts to decimal “19.”

Legal column addresses are 0 through 31. However, the address: Row 0, Column 31, is illegal.



---

## To Check the Error Queue

When you operate the modular signal generator, you may, inadvertently, create an error condition which causes the front panel **ERR** (Error) LED to light. Follow these steps in order to read the front panel error queue and determine what error condition has occurred.

1. Select the **DISPLAY** (**DSP**) key.
2. Select the **REPORT ERRORS** softkey.

When **REPORT ERRORS** is selected, the display shows the model number, description, and HP-MSIB address of the module that is reporting. If the HP 70340A has a row address of "0" (the default address), and it is reporting an error, the error can be displayed with the **REPORT ERRORS** function.

3. If necessary, press the **MORE ERRORS** softkey until the display shows HP 70340A, the signal generator column address, and the errors associated with the instrument.

If the HP 70340A is the only MMS module with a row address of 0, the **MORE ERRORS** function will not appear.

4. If necessary, refer to the **Error Messages** chapter of this book or to your display manual for steps to correct or clear the error.

Errors associated with the HP 70340A are shown in upper and lower case letters. However, errors associated with the display (which usually cause an abnormal display) are shown in all capital letters.

5. Select the **MENU** display key in order to exit the **Error Report** screen and return to the **HP 70340A** screen.

If the error is a transient one, it is cleared from memory once you exit the **Error Report** Screen. However, if the error is related to hardware, it cannot be cleared from memory until the hardware problem is corrected.

6. If necessary, refer to the "Error Messages" chapter of this book for the appropriate recovery procedure.

---

## If You Encounter a Problem

If you have a problem operating the signal generator or the display, check the following list of commonly encountered problems and troubleshooting procedures. If the problem that you encounter is not in the following list, refer to the Troubleshooting section of the *Installation and Verification Manual* for the MMS display module, or contact the nearest Hewlett-Packard office for service.

### If the data entry controls (Keypad, Knob, keys) do not respond:

- Check that neither the ENTRY HOLD nor the HOLD function is enabled.

The ENTRY HOLD function is under the **Misc** menu. It is active when it appears in inverse video. The **HOLD** key is on the display front panel. To return to normal entry mode if either of these functions is active, select (highlight) a function which has a numeric parameter associated with it.

- Check that the function which is selected accepts data.

For instance, CW FREQ accepts data, but, AMPTD On/Off does not. The data entry controls do not respond if the function selected does not have data associated with it.

- Check that the signal generator is in local (not remote) operating mode.

Press the **LCL** key on the front panel of the display to return the instrument to local operating mode.

### If no underscore appears with the data in the data entry box:

- Check that neither the ENTRY HOLD nor the HOLD function is enabled.

The ENTRY HOLD function is under the **Misc** menu. It is active when it appears in inverse video. The **HOLD** key is on the display front panel. To return to normal entry mode if either of these functions is active, select (highlight) a function which has a numeric parameter associated with it.

### If data is not accepted by the signal generator:

- Check that the **ERR** LED is off.

If the HP 70340A **ERR** LED is on, there is a problem with either the signal generator, the frequency extension module, or some other component in the MMS. To determine the error and turn off the **ERR** LED, refer to the procedure, "To Check the Error Queue," in Chapter 2, "Performing Fundamental Operations."

### If there is a problem with the display:

1. Refer to the display Operating Manual for operating and troubleshooting procedures.

### If the HP 70340A module front panel menu does not appear on the display screen:

1. Press the **DISPLAY** (**DSP**) key.
2. Select the **NEXT INSTR** softkey until the HP 70340A front panel is displayed.

The **DISPLAY** (**DSP**) key is located on the front panel of the display module. The **NEXT INSTR** softkey is located on the right-hand side of the display module screen.

### If the Modify Step functions do not appear when you select the Modify Step menu:

- Check that the active (selected) function has numeric data associated with it.

**If the signal generator does not display/output the CW FREQUENCY entered:**

- Check that the FREQUENCY MULTIPLIER value entered is correct.
- If the FREQUENCY MULTIPLIER is a value other than 1, the resolution of the instrument may not allow the exact frequency entered.

For example, if you require an output of 40 GHz and are using a frequency multiplier of 3, the signal generator should output a value of 13.33333333 GHz. The closest value that the signal generator can output, however, is 13.333333000 GHz since it has 1 kHz resolution. Thus, the signal generator will display 39.999999000 GHz, not 40.000000000 GHz, as the actual output at the multiplier.

- Check the “Specifications and Options” chapter to make sure that you have not set the parameter out of the range of the specification.

## Generating Signals

---

This chapter provides procedures for generating signals with the HP 70340A (and HP 70341A.) When the term “signal generator” is used, it refers to either the HP 70340A or the HP 70340A/41A combination.

Along with signal generation procedures, methods for performing external leveling and flatness correction are included. The steps in these procedures assume that you are familiar with basic signal generator and display operations. If you want to become more familiar with the Modular Measurement System, refer to the chapter, “Performing Fundamental Operations.” If you require additional programming information, refer to the *Beginner’s Guide to SCPI* (HP part number H2325-90001) or the “Programming Commands” chapter in this manual.

The procedures in this chapter are, for convenience, grouped by task similarity and in order of increasing complexity.

Several external pieces of equipment and accessories such as cables are required for these procedures. Each procedure lists external equipment that is required. For suggested cables, refer to the entry “Accessories (not included)” in the “Front and Rear Panel” chapter.

---

## To Generate a CW Signal

The signal generator can generate a CW (continuous wave) signal with no modulation characteristics.

### 1. Set the desired CW frequency.

For example, perform the following procedure to set the output frequency to 2.000203 GHz.

- Select the **Freq** menu in order to automatically select the **CW FREQ** function.
- Type **2 . 0 0 0 2 0 3** on the display numeric keypad.
- Terminate the frequency entry by selecting the **GHz** softkey.

The display now indicates:

```
Frequency
2.000203000GHz
```

### 2. Set the desired RF output amplitude.

For example, perform the following procedure to set the output amplitude to -15.1 dBm.

- Select the **Amptd** menu in order to automatically select **AMPTD**.
- Type **- 1 5 . 1** on the numeric keypad.
- Terminate the amplitude entry by pressing the **dBm** softkey.

The display now indicates:

```
Amplitude
-15.10dBm
```

### 3. Select **ALC INT** so that it is underscored in order to enable internal leveling.

Note that internal leveling is the default type of leveling. Thus, the ALC INTERNAL function may already be selected.

### 4. If the RF Output is off, turn it on by selecting **AMPTD On Off** so that **On** is underscored.

When the RF output is on, the display indicates RF ON.

### 5. If necessary, turn off any modulation: **LOG AM**, **FM**, or **PUSLE MODULATION** by selecting the **Modulation** menu and then pressing each function softkey so that **Off** is underscored.

Whether LOG AM, FM, and PULSE are on or off is indicated by underscoring **On** or **Off** in the associated softkey. The display also indicates which modulation types are on or off.

## Programming Example

In the following example, an internally leveled, CW signal will be generated at a frequency of 2.000203 GHz with a power level of  $-15.1$  dBm.

```
10 OUTPUT 719; "*RST"           Sets the instrument to a preset state.
20 OUTPUT 719; "FREQ 2.000203GHZ" Sets the output frequency to 2.000203 GHz.
30 OUTPUT 719; "POW:LEV -15.1DBM" Sets the output power level to -15.1 dBm.
40 OUTPUT 719; "OUTP:STAT ON"    Turns the RF output on.
50 OUTPUT 719; "POW:ALC:SOUR INT" Enables internal leveling.
60 END
```

---

## To Generate an AC FM Signal

You can generate an AC coupled frequency modulated (AC FM) signal at any carrier frequency within the signal generator output frequency range. AC coupling is useful when the modulating signal has a minimum rate of greater than 1 kHz in order to achieve frequency accuracy and stability.

Generating an AC FM signal requires the following external equipment.

| Equipment                | Requirements   |
|--------------------------|--|
| Modulating Signal Source | Modulating signal level must be in the range of +2V to -2V for specified FM performance. |

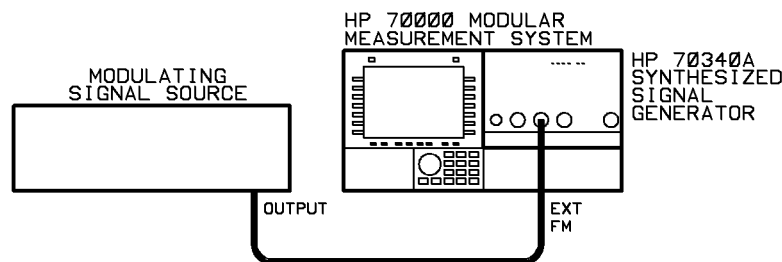

**Figure 3-1. AC FM Equipment Setup**

---

**Caution** The modulating signal must never exceed  $\pm 10\text{V}$  or damage to the input can occur. The input impedance of the EXT FM connector is  $600\Omega$ .

---

1. Connect the equipment as shown in Figure 3-1:
2. Select the **Amptd** menu.
3. Select the **ALC INT** function in order to enable internal leveling.
4. Set FM coupling to AC, if necessary.

Perform the following procedure to set FM coupling to AC.

- a. Select the **Misc** menu.
  - b. Select **MORE 1 of 2** to see more functions.
  - c. Set **FM TYPE AC DC** to **AC**.
5. Turn frequency modulation on.
- To turn FM on, perform the following steps:
- a. Select the **Modultn** menu.
  - b. Turn **FM On Off** **On**.

When frequency modulation is turned on, the display shows: **FM ON**.

### 3-4 Generating Signals

6. If necessary, turn off unwanted modulation: LOG AM, or PULSE MODULATION by selecting each function softkey so that Off is underscored.

Whether LOG AM and PULSE are on or off is indicated by underscoring **On** or **Off** in the softkey. The display also indicates which modulation types are enabled or disabled.

7. Set the desired carrier frequency.

For example, perform the following procedure to set the carrier frequency to 12.5 GHz.

- a. Select the **Freq** menu in order to automatically select the **CW FREQ** function.
- b. Type **1 2 . 5** on the display numeric keypad.
- c. Terminate the carrier frequency entry by pressing the **GHz** softkey.

The display now indicates:

```
Frequency
12.50000000GHZ
```

8. Set the desired RF output amplitude.

For example, perform the following procedure to set the output amplitude to -5 dBm:

- a. Select the **Amptd** menu in order to automatically select the **AMPTD** function.
- b. Type **- 5** on the display numeric keypad.
- c. Terminate the amplitude entry by pressing the **dBm** softkey.

The display now indicates:

```
Amplitude
-5.00dBm
```

9. Set the modulating signal source to the desired FM characteristics.
10. If the RF Output is off, turn it on by pressing **AMPTD On Off** so that **On** is underscored.

When the RF output is on, the display indicates RF ON.

## Programming Example

In the following example, an internally leveled, AC coupled FM signal will be generated at a carrier frequency of 12.5 GHz with a power level of -5 dBm. In order to accomplish this, connect the equipment as shown in Figure 3-1, set the modulating signal source for the desired FM characteristics, and then run the following program.

```
10 OUTPUT 719; "*RST"           Sets the instrument to preset state.
20 OUTPUT 719; "FM:COUP AC"     Sets FM coupling to AC.
30 OUTPUT 719; "FM:STAT ON"    Turns frequency modulation on.
40 OUTPUT 719; "POW:ALC:SOUR INT" Enables internal leveling.
50 OUTPUT 719; "FREQ 12.5GHZ"  Sets the carrier frequency to 12.5 GHz.
60 OUTPUT 719; "POW:LEV -5DBM" Sets the output amplitude to -5 dBm.
70 OUTPUT 719; "OUTP:STAT ON"  Turns the RF output on.
80 END
```



---

## To Generate a Power Sweep

The signal generator can generate a power sweep by connecting the output of a function generator to the **EXT AM** connector and modulating the RF output with a sawtooth wave. This has the effect of linearly sweeping the power level of the RF output from a lower power level value to a higher power level value (or vice versa) at a regular interval.

Generating a power sweep requires the following external equipment.

| Equipment          | Requirements  |
|--------------------|---|
| Function Generator | Must be capable of producing a sawtooth signal from a minimum of 0 volts to a maximum up to +6 volts, depending on the amount of attenuation required in the power sweep. |

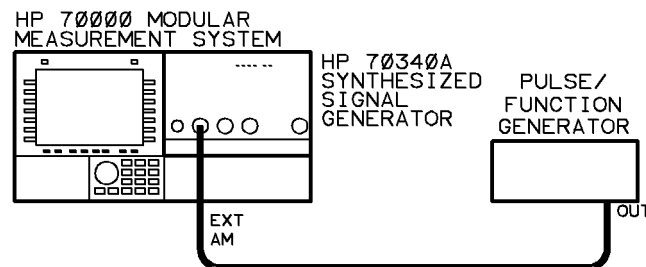

Figure 3-2. Log AM Equipment Setup

---

**Caution** The sawtooth signal must never exceed the range of +15.5V to -15.5V or damage to the **EXT AM** input can occur. The input impedance of the **EXT AM** connector is 5 k $\Omega$ .

---

1. Connect the equipment as shown in Figure 3-2.
2. Select the **Amptd** menu and then the **ALC INT** function in order to enable internal leveling.
3. Select the **Modultn** menu and then **LOG AM On Off** in order to turn logarithmic amplitude modulation on.

When LOGARITHMIC AM is on, the display indicates: AM ON.

4. If necessary, turn off any modulation: **FM** or **PULSE MODULATION** by selecting the **Modulation** menu and then pressing each function softkey so that **Off** is underscored.

The display indicates which modulation types are on or off.

5. Set the desired carrier frequency.

For example, perform the following procedure to set the carrier frequency to 12.5 GHz.

- a. Select the **Freq** menu in order to automatically select the **CW FREQ** function.
- b. Type **1 2 . 5** on the display numeric keypad.
- c. Terminate the carrier frequency entry by pressing the **GHz** softkey.

The display now indicates:

```
Frequency
12.500000000GHz
```

6. **Set the desired RF output amplitude to the highest value needed for the power sweep.**

For example, if the power is to sweep from  $-30$  dBm to  $-5$  dBm, perform the following procedure to set the output amplitude to  $-5$  dBm.

- a. Select the **Amptd** menu in order to automatically select the **AMPTD** function.
- b. Type **(-) 5** on the display numeric keypad.
- c. Terminate the amplitude entry by pressing the **dBm** softkey.

The display now indicates:

```
Amplitude
-5.00 dBm
```

7. **Set the controls of the function generator for a sawtooth waveform (see Figure 3-3) that produces the desired power sweep.**

For every  $+1$  volt at the **EXT AM** connector, The RF output is attenuated by  $10$  dB. For example, the following waveform at the **EXT AM** connector causes the RF output to sweep linearly from  $-5$  dBm to  $-30$  dBm every  $100$  ms.

The power sweep can vary from a lower to a higher power value or vice versa, depending on the slope of the sawtooth waveform. Note that maximum frequency of the sawtooth waveform that produces a linear power sweep depends on the voltage excursion of the waveform.

Refer to the “Specifications and Options” chapter for the actual limitation.

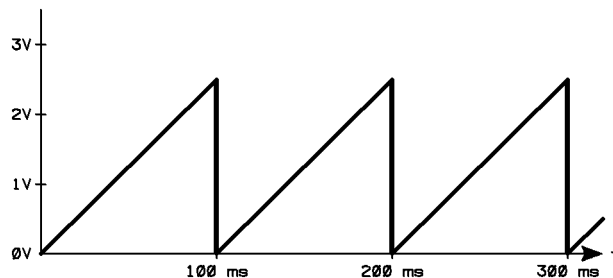

**Figure 3-3. Example Sawtooth Waveform**

8. **If the RF output is off, turn it on by pressing **AMPTD On Off** so that On is underscored.**

When the RF output is on, the display indicates RF ON.

## Programming Example

In the following example, a power sweep will be generated at a carrier frequency of 2.3 GHz. The power will sweep from a minimum level of  $-30$  dBm to a maximum level of  $-5$  dBm.

To program the signal generator to generate the power sweep explained above, connect the equipment as in the above procedure. Set the function generator to generate a sawtooth waveform similar to that in Figure 3-3, and then run the following program.

```
10 OUTPUT 719; "*RST"           Sets the instrument to preset state.
20 OUTPUT 719; "AM:STAT ON"     Turns logarithmic amplitude modulation on.
30 OUTPUT 719; "POW:ALC:SOUR INT" Enables internal leveling.
40 OUTPUT 719; "FREQ 2.3GHZ"    Sets the carrier frequency to 2.3 GHz.
50 OUTPUT 719; "POW:LEV -5DBM"  Sets the output amplitude to -5 dBm (the maximum level needed in the power sweep).

60 OUTPUT 719; "OUTP:STAT ON"   Turns the RF output on.
70 END
```

---

## To Generate Internal Pulse Modulation

If your instrument has Option 1E2, you can generate a pulse modulated signal at any carrier frequency within the signal generator output frequency range. When internal pulse modulation is used, the pulsed RF output signal will have pulse width, delay, and pulse repetition frequency parameters set via the signal generator front panel.

### 1. Set the desired carrier frequency.

For example, perform the following procedure to set the carrier frequency to 3.085 GHz.

- Select the **Freq** menu in order to automatically select the **CW FREQ** function.
- Type **30085** on the signal generator numeric keypad.
- Terminate the carrier frequency entry by selecting the **GHz** softkey.

### 2. Set the desired RF output amplitude level.

For example, perform the following procedure to set the output amplitude to -26 dBm.

- Select the **Amptd** menu in order to automatically select **AMPTD**.
- Type **-26** on the signal generator numeric keypad.
- Terminate the power level entry by pressing the **GHz** softkey.

### 3. Select **ALC INT** to enable internal leveling.

### 4. If the RF output is currently turned off, select **Amptd** and then **AMPTD On Off** to turn it on.

When the RF output is on, RF ON appears in the display.

### 5. If necessary, turn off any modulation: FM or LOG AM by selecting the Modulation menu and then pressing each function softkey so that Off is underscored.

The display indicates which modulation types are on or off.

### 6. Select **Modultn**, **pulse modultn**, **intern pulse**, and, then, **INTERN PULSE** to turn internal pulse modulation on.

When internal pulse modulation is turned on, the display indicates Pulse Internal.

### 7. Set the desired pulse repetition interval (PRI).

For example, perform the following procedure to set the pulse repetition interval to 100 ms.

- Select **PRI**.
- Type **100** on the signal generator numeric keypad.
- Terminate the pulse repetition frequency entry by pressing the **GHz** softkey.

### 8. Set the desired pulse width.

For example, perform the following procedure to set the pulse width to 25 ms.

- a. Select **PULSE WIDTH**.
  - b. Type **2 5** on the signal generator numeric keypad.
  - c. Terminate the pulse width entry by pressing the **GHz** softkey.
9. **Set the desired pulse delay.**

For example, perform the following procedure to set the pulse delay to 200  $\mu$ s.

- a. Select **PULSE DELAY**.
- b. Type **2 0 0** on the signal generator numeric keypad.
- c. Terminate the pulse delay entry by pressing the **MHz** softkey.

The signal generator will produce a pulsed RF output signal with pulse width, delay, and pulse repetition frequency parameters set via the front panel.

---

**Note** If the signal generator pulsed RF output is to be connected to average power sensitive circuitry, refer to PWR LIM On/Off in the “Menus and Functions” chapter of this manual.

---

### Programming Example

In the following example, an internally leveled, internally pulse modulated signal will be generated at a carrier frequency of 3.085 GHz with a power level of  $-26$  dBm. The pulses will have pulse repetition interval of 100 ms with a 25 ms pulse width and a 200  $\mu$ s delay.

|                                       |  |
|---------------------------------------|--|
| 10 OUTPUT 719; "*RST"                 | <i>Presets the signal generator.</i>                           |
| 20 OUTPUT 719; "PULM:SOUR INT"        | <i>Sets pulse source to internal.</i>                          |
| 30 OUTPUT 719; "TRIG:SOUR IMM"        | <i>Sets pulse trigger source to immediate (non-triggered).</i> |
| 40 OUTPUT 719; "PULM:STAT ON"         | <i>Turns pulse modulation on.</i>                              |
| 50 OUTPUT 719; "POW:ALC:SOUR INT"     | <i>Enables internal leveling.</i>                              |
| 60 OUTPUT 719; "FREQ 3.085GHZ"        | <i>Sets the carrier frequency to 3.085 GHz.</i>                |
| 70 OUTPUT 719; "POW:LEV -26DBM"       | <i>Sets the output amplitude to <math>-26</math> dBm.</i>      |
| 80 OUTPUT 719; "POW:PROT:STAT ON OFF" | <i>Turns average power inhibit on or off.</i>                  |
| 90 OUTPUT 719; "PULS:PER 100MS"       | <i>Sets the pulse repetition interval to 100 ms.</i>           |
| 100 OUTPUT 719; "PULS:WIDT 25MS"      | <i>Sets the pulse width to 25 ms.</i>                          |
| 110 OUTPUT 719; "PULS:DEL 200US"      | <i>Sets the pulse delay to 200 <math>\mu</math>s.</i>          |
| 120 OUTPUT 719; "OUTP:STAT ON"        | <i>Turns the RF output on.</i>                                 |
| 130 END                               |  |

## Related Tasks

- `PWR LIM On Off`
- To Generate Externally Triggered Pulse Modulation
- To Generate External Pulse Modulation
- To Generate a Doublet Pulse
- To Generate Gated Pulse Modulation
- To Generate Simultaneous Log AM and Pulse Modulation

---

## To Generate Externally Triggered Pulse Modulation

If your instrument has Option 1E2, you can generate an externally triggered, pulse modulated signal at any carrier frequency within the signal generator output frequency range. When externally triggered pulse modulation is used, a valid TTL level trigger signal at the **PULSE/TRIG, GATE IN** connector will cause pulsed RF to appear at the **RF OUTPUT** connector with pulse width and delay set with the PULSE WIDTH and PULSE DELAY functions.

Generating externally triggered, pulse modulated signals requires the following external equipment.

| Equipment             | Requirements  |
|-----------------------|---|
| Trigger Signal Source | Must be capable of sourcing a TTL level signal into a 50Ω load. |

---

**Caution** The trigger signal must never exceed the range of +5.5V to –0.5V or damage to the **PULSE/TRIG, GATE IN** input can occur.

---

1. Connect the equipment as shown in Figure 3-4:

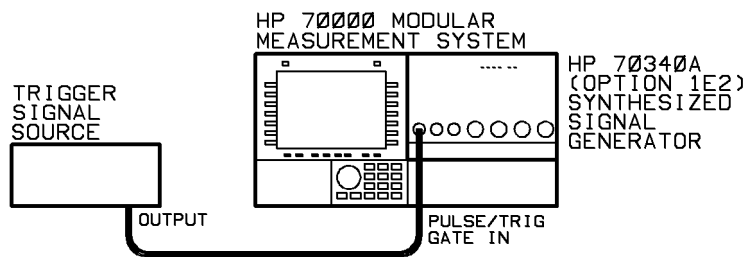

**Figure 3-4. Externally Triggered Pulse Modulation Equipment Setup**

2. Set the desired carrier frequency.

For example, perform the following procedure to set the carrier frequency to 5 GHz.

- a. Select the **Freq** menu in order to automatically select **CW FREQ**.
- b. Type **5** on the signal generator numeric keypad.
- c. Terminate the carrier frequency entry by selecting the **GHz** softkey.

3. Set the desired RF output amplitude level.

For example, perform the following procedure to set the output amplitude to –5 dBm.

- a. Select the **Amptd** menu in order to automatically select **AMPTD**.
- b. Type **5** on the signal generator numeric keypad.
- c. Terminate the entry by selecting the **GHz** softkey.

4. Select **ALC INT** to enable internal leveling.

5. If the RF output is currently turned off, select **AMPTD On Off** to turn it on.

When the RF output is on, RF ON appears in the display.

6. If necessary, turn off any modulation: FM or LOG AM by selecting the Modulation menu and then pressing each function softkey so that Off is underscored.

The display indicates which modulation types are on or off.

7. Select **Modultn**, **pulse modultn**, **trigger pulse**, and then **TRIG PULSE** to turn externally triggered internal pulse modulation on.

When externally triggered internal pulse modulation is turned on, the display indicates Pulse Internal Trigger.

8. Set the desired pulse width.

For example, perform the following procedure to set the pulse width to 23 ms.

a. Select **PULSE WIDTH**.

b. Type **2 3** on the signal generator numeric keypad.

c. Terminate the pulse width entry by selecting the **GHz** softkey.

9. Set the desired pulse delay.

For example, perform the following procedure to set the pulse delay to 100  $\mu$ s.

a. Select **PULSE DELAY**.

b. Type **1 0 0** on the signal generator numeric keypad.

c. Terminate the pulse delay entry by selecting the **MHz** softkey.

10. Set the controls of the trigger signal source to generate the desired external pulse trigger signal.

When the signal generator receives a valid trigger signal from the trigger signal source, an RF pulse will appear at the signal generator **RF OUTPUT** connector with width and delay parameters set with the PULSE WIDTH and PULSE DELAY functions. For example, if the width has been set to 23 ms and delay has been set to 100  $\mu$ s, the pulse shown in Figure 3-5 will result with a valid trigger signal.



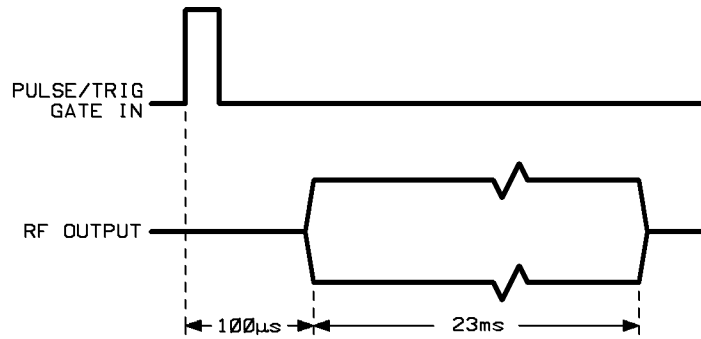

**Figure 3-5. Triggered Pulse Mode Timing Example**

---

**Note** If the signal generator pulsed RF output is to be connected to average power sensitive circuitry, refer to PWR LIM On/Off in the “Menus and Functions” chapter of this manual.

---

### Programming Example

In the following example, an internally leveled, externally triggered pulse modulated signal will be generated at a carrier frequency of 5 GHz with a power level of  $-5$  dBm. The pulses will have a 23 ms pulse width and a 100  $\mu$ s delay.

To program the signal generator to generate the signal explained above, connect the equipment as shown in Figure 3-4, set the trigger signal source for the desired triggering characteristics, and then run the following program.

|                                       |  |
|---------------------------------------|--|
| 10 OUTPUT 719; "*RST"                 | <i>Presets the signal generator.</i>                     |
| 20 OUTPUT 719; "PULM:SOUR INT"        | <i>Sets pulse source to internal.</i>                    |
| 30 OUTPUT 719; "TRIG:SOUR EXT"        | <i>Enables triggered pulse mode.</i>                     |
| 40 OUTPUT 719; "PULM:STAT ON"         | <i>Turns pulse modulation on.</i>                        |
| 50 OUTPUT 719; "POW:ALC:SOUR INT"     | <i>Enables internal leveling.</i>                        |
| 60 OUTPUT 719; "FREQ 5GHZ"            | <i>Sets the carrier frequency to 5 GHz.</i>              |
| 70 OUTPUT 719; "POW:LEV -5DBM"        | <i>Sets the output amplitude to <math>-5</math> dBm.</i> |
| 80 OUTPUT 719; "POW:PROT:STAT ON OFF" | <i>Turns average power inhibit on or off.</i>            |
| 90 OUTPUT 719; "PULS:WIDT 23MS"       | <i>Sets the pulse width to 23 ms.</i>                    |
| 100 OUTPUT 719; "PULS:DEL 100US"      | <i>Sets the pulse delay to 100 <math>\mu</math>s.</i>    |
| 110 OUTPUT 719; "OUTP:STAT ON"        | <i>Turns the RF output on.</i>                           |
| 120 END                               |  |

### Related Tasks

- **PWR LIM On Off**
- To Generate Internal Pulse Modulation
- To Generate External Pulse Modulation
- To Generate a Doublet Pulse
- To Generate Gated Pulse Modulation
- To Generate Simultaneous Log AM and Pulse Modulation

---

## To Generate External Pulse Modulation

You can generate a pulse modulated signal at any carrier frequency within the signal generator output frequency range. When external pulse modulation is used, the pulsed RF output signal has pulse width and repetition frequency parameters set via an external pulse source.

Generating external pulse modulation requires the following external equipment.

| Equipment    | Requirements  |
|--------------|---|
| Pulse Source | Must be capable of sourcing a TTL level signal into a 50Ω load. |

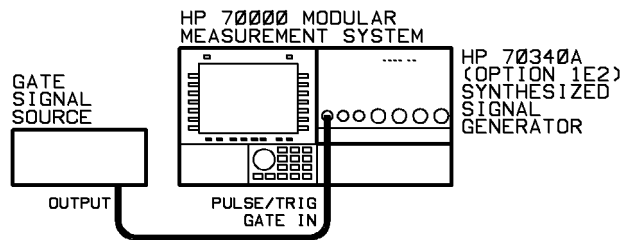

**Figure 3-6. External Pulse Modulation Equipment Setup**

---

**Caution** The pulse modulating signal must never exceed the range of +5.5V to –0.5V or damage to the **EXT PULSE** input can occur.

---

**Note** If the signal generator pulsed RF Output is connected to average power sensitive circuitry, refer to the PWR LIM On/Off entry in the “Menus and Functions” chapter of this book.

---

1. **Connect the equipment as shown in Figure 3-6.**
2. **Set the desired carrier frequency.**

For example, perform the following procedure to set the carrier frequency to 2.5 GHz.

- a. Select the **Freq** menu in order to automatically select the **CW FREQ** function.
- b. Type **2 0 5** on the display numeric keypad.
- c. Terminate the carrier frequency entry by selecting the **GHz** softkey.

The display now indicates:

```
Frequency
2.500000000GHz
```

3. **Set the desired RF output amplitude.**

For example, perform the following procedure to set the output amplitude to –5 dBm:

- a. Select the **Amptd** menu in order to automatically select the **AMPTD** function.
- b. Type **(-) 5** on the display numeric keypad.

- c. Terminate the amplitude entry by selecting the **dBm** softkey.
4. Select the **ALC INT** function in order to enable internal leveling.
5. Set the controls of the pulse source to the desired pulse PRF and width.
6. If the RF output is off, turn it on by selecting **AMPTD On Off**.

When the RF output is on, the display indicates RF ON.

7. If necessary, turn off any unwanted modulation: LOG AM or FM by selecting the **Modulation** menu and then selecting each function softkey so that **Off** is underscored.

Whether LOG AM and FM are on or off is indicated by underscoring **On** or **Off** in the softkey. The display also indicates which modulation types are on or off.

8. If your instrument does not have Option 1E2:

- a. Select **Modultn** and then **PULSE On Off** to turn pulse modulation on.

The display indicates Pulse Off when pulse modulation is off.

- b. Select normal (noninverted) or inverted pulse modulation with the **PULSE Nml Inv** function.

The display indicates whether normal or inverted pulse modulation is on by the message: Pulse External or Pulse External Inverted.

9. If your instrument contains Option 1E2:

- a. Select the **Modultn** menu and then the **pulse modultn** menu.

- b. Select **EXTERN NORMAL** or **EXTERN INVERT** in order to choose between normal and inverted pulse modulation.

The display indicates whether normal or inverted pulse modulation is on by the message: Pulse External or Pulse External Inverted.

Note that if inverted external pulse modulation is used, the external pulse modulating signal sense is inverted before affecting the envelope of the pulse modulated RF output signal.

The signal generator now produces a pulsed RF output signal with pulse width and repetition frequency parameters that are set with an external pulse source.

## Programming Example

In the following example, an internally leveled, externally pulse modulated signal will be generated at a carrier frequency of 12.02 GHz with a power level of  $-25$  dBm. The pulse characteristics (PRI, width) will be set with an external pulse source.

To program the signal generator to generate the signal explained above, connect the equipment as shown in the above procedure, set the pulse source for the desired PRI and width, and then run the following program.

```

10 OUTPUT 719; "*RST"           Sets the instrument to preset state.
20 OUTPUT 719; "PULM:SOUR EXT"   Sets pulse source to external.
30 OUTPUT 719; "PULM:EXT:POL NORM|INV" Sets external pulse polarity. Choose "NORM"
                                   for non-inverted external pulse modulation or
                                   "INV" for inverted external pulse modulation.

```

|                                   |   |
|-----------------------------------|---|
| 40 OUTPUT 719; "PULM:STAT ON"     | <i>Turns pulse modulation on.</i>               |
| 50 OUTPUT 719; "POW:ALC:SOUR INT" | <i>Enables internal leveling.</i>               |
| 60 OUTPUT 719; "FREQ 12.02GHZ"    | <i>Sets the carrier frequency to 12.02 GHz.</i> |
| 70 OUTPUT 719; "POW:LEV -25DBM"   | <i>Sets the output amplitude to -25 dBm.</i>    |
| 80 OUTPUT 719; "OUTP:STAT ON"     | <i>Turns the RF output on.</i>                  |
| 90 END                            |   |

## Related Tasks

- PWR LIM On Off
- To Use External Diode Detector Leveling
- To Generate Externally Triggered Pulse Modulation
- To Generate a Doublet Pulse
- To Generate Gated Pulse Modulation
- To Generate Simultaneous Log AM and Pulse Modulation

---

## To Generate a Doublet Pulse

If your instrument has Option 1E2, you can generate a doublet pulse at any carrier frequency within the signal generator output frequency range. When a doublet pulse is generated, the signal generator will generate two RF pulses. The envelope of the first RF pulse will follow a valid (TTL high) pulse provided at the **PULSE/TRIG, GATE IN** connector. The second RF pulse is generated internally and will have a pulse width and pulse delay as set with the PULSE WIDTH and PULSE DELAY functions.

Generating doublet pulses requires the following external equipment.

| Equipment    | Requirements  |
|--------------|---|
| Pulse Source | Must be capable of sourcing a TTL level signal into a 50Ω load. |

---

**Caution** The pulse modulating signal must never exceed the range of +5.5V to –0.5V or damage to the **PULSE/TRIG, GATE IN** input can occur.

---

1. Connect the equipment as shown in Figure 3-7:

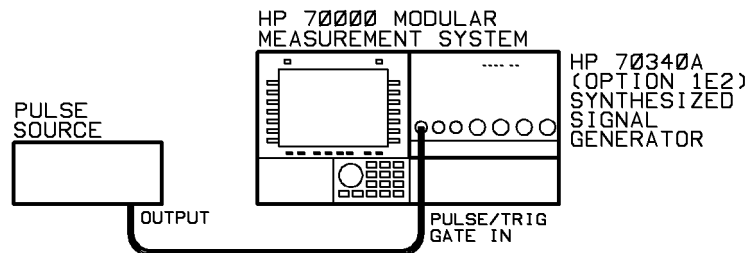

Figure 3-7. Doublet Pulse Equipment Setup

2. Set the desired carrier frequency.

For example, perform the following procedure to set the carrier frequency to 10 GHz.

- a. Select the **Freq** menu in order to automatically select the **CW FREQ** function.
- b. Type **1 0** on the signal generator numeric keypad.
- c. Terminate the carrier frequency entry by selecting the **GHz** softkey.

3. Set the desired RF output amplitude level.

For example, perform the following procedure to set the output amplitude to –25 dBm.

- a. Select the **Amptd** menu in order to automatically select the **AMPTD** function.
- b. Type **– 2 5** on the signal generator numeric keypad.
- c. Terminate the power level entry by selecting the **GHz** softkey.

4. Select **ALC INT** to enable internal leveling.

5. If the RF output is currently turned off, select **AMPTD On Off** to turn it on.

When the RF output is on, RF ON appears in the display.

6. If necessary, turn off any unwanted modulation: LOG AM or FM by selecting the **Modulation** menu and then selecting each function softkey so that **Off** is underscored.

Whether LOG AM and FM are on or off is indicated by underscoring **On** or **Off** in the softkey. The display also indicates which modulation types are on or off.

7. Select **Modul<sup>tn</sup>**, **pulse modul<sup>tn</sup>**, **doublet pulse**, and then **DOUBLET PULSE** to turn on doublet pulse mode.

When doublet pulse mode is turned on, the text “Pulse Doublet” appears in the display.

8. Set the desired pulse width.

For example, perform the following procedure to set the pulse width to 1  $\mu$ s.

- a. Press the **PULSE WIDTH** softkey.
- b. Type **1** on the signal generator numeric keypad.
- c. Terminate the pulse width entry by selecting the **MHz** softkey.

9. Set the desired pulse delay.

For example, perform the following procedure to set the pulse delay to 2  $\mu$ s.

- a. Press the **PULSE DELAY** softkey.
- b. Type **2** on the signal generator numeric keypad.
- c. Terminate the pulse delay entry by selecting the **MHz** softkey.

10. Set the controls of the pulse source to generate the desired pulse.

Delay is measured from the rising edge of the input pulse. By varying the signal generator delay time, you can vary the off time between the two pulses. This is useful when testing receiver recovery time (shadow time). For example, if the width has been set to 1  $\mu$ s and delay has been set to 2  $\mu$ s, the pulses shown in Figure 3-8 will result upon a 500 ns gate signal.

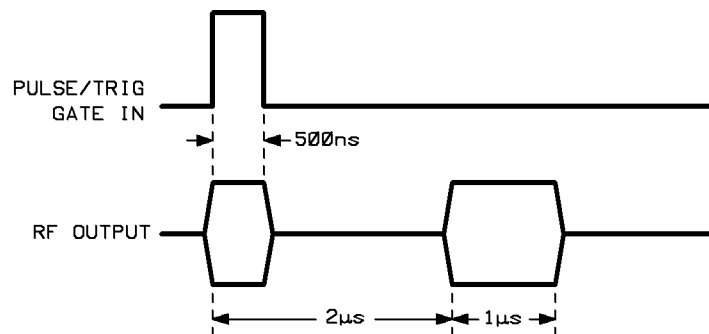

Figure 3-8. Doublet Pulse Mode Timing Example

---

**Note** If the signal generator pulsed RF output is to be connected to average power sensitive circuitry, refer to PWR LIM On/Off in the “Menus and Functions” chapter of this manual.

---

## Programming Example

In the following example, doublet pulses will be generated at a carrier frequency of 10 GHz with a power level of  $-25$  dBm. The pulses will have a  $1 \mu\text{s}$  pulse width and a pulse delay of  $2 \mu\text{s}$ .

To program the signal generator to generate the pulses explained above, connect the equipment as shown in Figure 3-7, set the gate signal source for the desired gate pulse characteristics, and then run the following program.

|   |  |
|---|--|
| 10 OUTPUT 719; "*RST"                         | <i>Presets the signal generator.</i>                       |
| 20 OUTPUT 719; "PULM:SOUR INT"                | <i>Sets pulse source to internal.</i>                      |
| 30 OUTPUT 719; "PULS:DOUB ON"                 | <i>Enables doublet pulse mode.</i>                         |
| 40 OUTPUT 719; "PULM:STAT ON"                 | <i>Turns pulse modulation on.</i>                          |
| 50 OUTPUT 719; "POW:ALC:SOUR INT"             | <i>Enables internal leveling.</i>                          |
| 60 OUTPUT 719; "FREQ 10GHZ"                   | <i>Sets the carrier frequency to 10 GHz.</i>               |
| 70 OUTPUT 719; "POW:LEV -25DBM"               | <i>Sets the output amplitude to <math>-25</math> dBm.</i>  |
| 80 OUTPUT 719; "POW:PROT:STAT <u>ON OFF</u> " | <i>Turns average power inhibit on or off.</i>              |
| 90 OUTPUT 719; "PULS:WIDT 1US"                | <i>Sets the pulse width to <math>1 \mu\text{s}</math>.</i> |
| 100 OUTPUT 719; "PULS:DEL 2US"                | <i>Sets the pulse delay to <math>2 \mu\text{s}</math>.</i> |
| 110 OUTPUT 719; "OUTP:STAT ON"                | <i>Turns the RF output on.</i>                             |
| 120 END                                       |  |

## Related Tasks

- **PWR LIM On Off**
- To Generate Internal Pulse Modulation
- To Generate Externally Triggered Pulse Modulation
- To Generate External Pulse Modulation
- To Generate Gated Pulse Modulation
- To Generate Simultaneous Log AM and Pulse Modulation

---

## To Generate Gated Pulse Modulation

If your instrument has Option 1E2, you can generate a gated, pulse modulated signal at any carrier frequency within the signal generator output frequency range. When gated pulse modulation is used, a valid TTL level gate signal at the **PULSE/TRIG, GATE IN** connector will cause pulsed RF to appear at the **RF OUTPUT** connector as long as the gate signal remains at a TTL high level. The pulsed RF output will have a pulse width and pulse repetition frequency as set with the PULSE WIDTH and PRF (or PRI) functions.

Generating gated, pulse modulated signals requires the following external equipment.

| Equipment          | Requirements  |
|--------------------|---|
| Gate Signal Source | Must be capable of sourcing a TTL level signal into a 50Ω load. |

---

**Caution** The gate signal must never exceed the range of +5.5V to –0.5V or damage to the **PULSE/TRIG, GATE IN** input can occur.

---

1. Connect the equipment as shown in Figure 3-9:

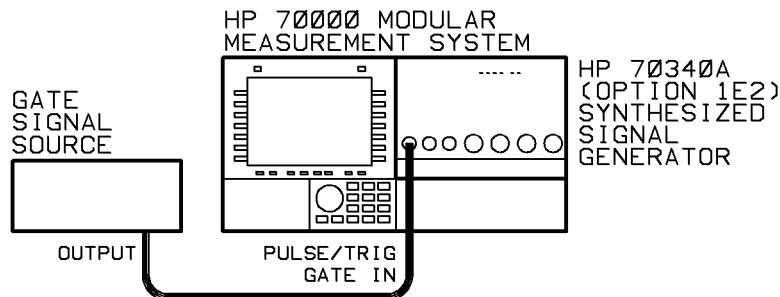

**Figure 3-9. Gated Pulse Modulation Equipment Setup**

2. Set the desired carrier frequency.

For example, perform the following procedure to set the carrier frequency to 6.67 GHz.

- a. Select the **Freq** menu in order to automatically select the **CW FREQ** function.
- b. Type **6 . 6 7** on the signal generator numeric keypad.
- c. Terminate the carrier frequency entry by selecting the **GHz** softkey.

3. Set the controls of the gate signal source to generate the desired gate signal.

4. Set the desired RF output amplitude level.

For example, perform the following procedure to set the output amplitude to –45 dBm.

- a. Select the **Amptd** menu in order to automatically select the **AMPTD** function.
- b. Type **- 4 5** on the signal generator numeric keypad.



c. Terminate the power level entry by selecting the **GHz** softkey.

5. Select **ALC INT** to enable internal leveling.

6. If the RF output is currently turned off, select **AMPTD On Off** to turn it on.

When the RF output is on, RF ON appears in the display.

7. If necessary, turn off any modulation: FM or LOG AM by selecting the Modulation menu and then pressing each function softkey so that Off is underscored.

The display indicates which modulation types are on or off.

8. Select **Modul<sup>tn</sup>**, **pulse modul<sup>tn</sup>**, **gated pulse**, and **GATED PULSE** in order to turn on gated pulse modulation.

When gated pulse modulation is turned on, the text “Pulse Gated” appears in the display.

9. Set the desired pulse width.

For example, perform the following procedure to set the pulse width to 100  $\mu$ s.

a. Select **PULSE WIDTH**.

b. Type **1 0 0** on the signal generator numeric keypad.

c. Terminate the pulse width entry by selecting the **MHz** softkey.

10. Set the desired pulse repetition frequency, PRF.

For example, perform the following procedure to set the pulse repetition frequency to 1 kHz.

a. Select **PRF**.

b. Type **1** on the signal generator numeric keypad.

c. Terminate the pulse repetition frequency entry by selecting the **KHz** softkey.

When the gate signal from the gate signal source is at a TTL high level, RF pulses will appear at the signal generator **RF OUTPUT** connector for as long as the gate signal remains high. If the gate signal switches to a TTL low level during when a pulse is present at the **RF OUTPUT**, the last pulse will complete before the pulse train ceases. For example, if the width has been set to 100  $\mu$ s and PRF has been set to 1 kHz (PRI set to 1 ms), the pulses shown in Figure 3-10 will result in a valid gate signal.

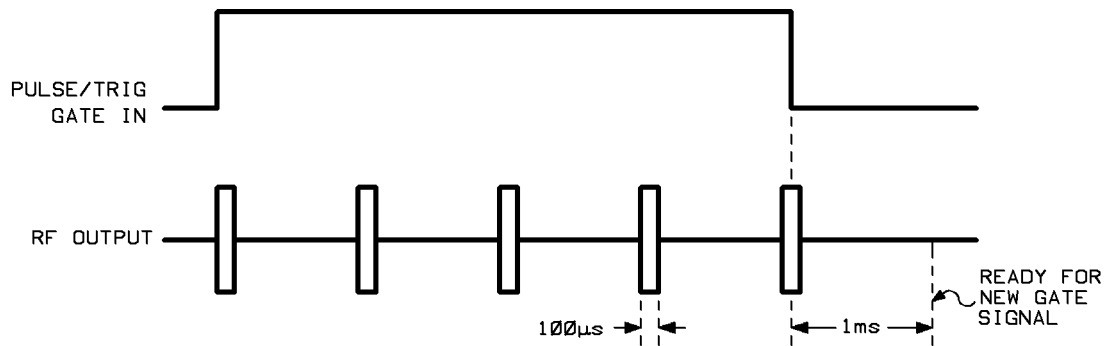

**Figure 3-10. Gated Pulse Mode Timing Example**

**Note** If the signal generator pulsed RF output is to be connected to average power sensitive circuitry, refer to PWR LIM On Off in the “Menus and Functions” chapter of this manual.

### Programming Example

In the following example, a gated, pulse modulated signal will be generated at a carrier frequency of 6.67 GHz with a power level of  $-45$  dBm. The pulses will have a  $100 \mu\text{s}$  pulse width and a pulse repetition frequency of 1 kHz..

To program the signal generator to generate the signal explained above, connect the equipment as shown in Figure 3-9, set the gate signal source for the desired gate signal characteristics, and then run the following program.

|                                       |  |
|---------------------------------------|--|
| 10 OUTPUT 719; "*RST"                 | <i>Presets the signal generator.</i>                         |
| 20 OUTPUT 719; "PULM:SOUR INT"        | <i>Sets pulse source to internal.</i>                        |
| 30 OUTPUT 719; "TRIG:SOUR EXT"        | <i>Enables triggered pulse mode.</i>                         |
| 40 OUTPUT 719; "TRIG:STOP:SOUR EXT"   | <i>Sets the pulse trigger stop source to external.</i>       |
| 50 OUTPUT 719; "PULM:STAT ON"         | <i>Turns pulse modulation on.</i>                            |
| 60 OUTPUT 719; "POW:ALC:SOUR INT"     | <i>Enables internal leveling.</i>                            |
| 70 OUTPUT 719; "FREQ 6.67GHZ"         | <i>Sets the carrier frequency to 6.67 GHz.</i>               |
| 80 OUTPUT 719; "POW:LEV -45DBM"       | <i>Sets the output amplitude to <math>-45</math> dBm.</i>    |
| 90 OUTPUT 719; "POW:PROT:STAT ON OFF" | <i>Turns average power inhibit on or off.</i>                |
| 100 OUTPUT 719; "PULS:WIDT 100US"     | <i>Sets the pulse width to <math>100 \mu\text{s}</math>.</i> |
| 110 OUTPUT 719; "PULS:FREQ 1KHZ"      | <i>Sets the pulse repetition frequency to 1 kHz.</i>         |
| 120 OUTPUT 719; "OUTP:STAT ON"        | <i>Turns the RF output on.</i>                               |
| 130 END                               |  |

### Related Tasks

- **PWR LIM On Off**
- To Generate Internal Pulse Modulation
- To Generate Externally Triggered Pulse Modulation
- To Generate External Pulse Modulation
- To Generate a Doublet Pulse
- To Generate Simultaneous Log AM and Pulse Modulation

---

## To Generate Millimeter Signals

By using external equipment with the signal generator, you can generate millimeter wave signals.

In order to generate millimeter-wave signals, the following external equipment is suggested.

| Equipment                         | Requirements   |
|-----------------------------------|--|
| HP 8349B Microwave Amplifier      | Must be compatible with the Millimeter Source Module used. |
| HP 8355X Millimeter Source Module | Must generate a signal at the desired frequency.           |

In addition, you must supply any cables and adapters necessary to connect the equipment.

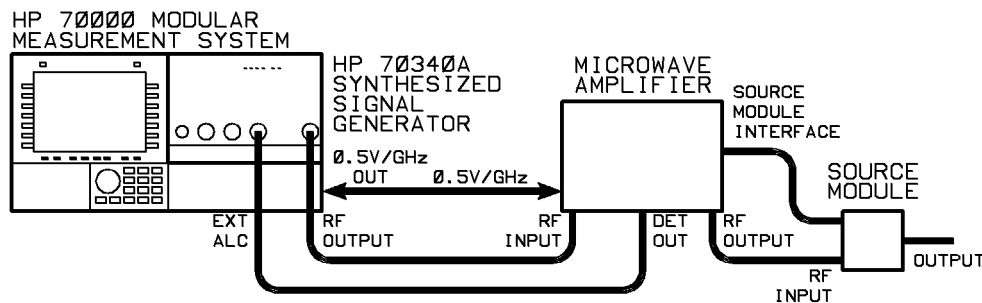

Figure 3-11. Millimeter Wave Equipment Setup

1. Connect the equipment as shown in the Figure 3-11:

---

**Caution** Turn off the AC power to the HP 8349B prior to connecting or disconnecting the millimeter source module interface cable.

---

2. Enter the proper HP 8355X-series source module multiplier value into the signal generator.

Perform the following procedure to select and enter the proper multiplier value.

- a. Select the **Freq** menu.
- b. Select the **FREQ MULT** function.
- c. Press the number key on the display numeric keypad that corresponds to the proper multiplier value from the following table:

| millimeter source module<br>Model Number | Frequency Band | Multiplier<br>Value |
|--|----------------|---------------------|
| HP 83554A                                | 26.5 - 40 GHz  | 2                   |
| HP 83555A                                | 33 - 50 GHz    | 3                   |
| HP 83556A                                | 40 - 60 GHz    | 3                   |
| HP 83557A                                | 50 - 75 GHz    | 4                   |
| HP 83558A                                | 75 - 110 GHz   | 6                   |

d. Terminate the multiplier value entry by selecting the **ENTER** softkey.

**3. Set the frequency of your desired output signal.**

Notice that the signal generator frequency display shows the frequency and modulation parameters at the output of the millimeter source module, not the signal generator RF OUTPUT connector.

For example, if you want to generate a 30 GHz CW only signal, perform the following steps:

- a. Select the **CW FREQ** function.
- b. Type **30** on the numeric keypad.
- c. Select the **GHz** softkey to terminate the entry.

**4. If the RF output is off, turn it on by selecting the **Amptd** menu and then the **AMPTD On Off** function.**

When the RF output is on, the display indicates RF ON.

**5. Select the **ALC INT** function in order to activate internal leveling.**

**6. Set the approximate desired RF output amplitude at the output of the millimeter source module using the microwave amplifier display.**

These two steps are necessary in order to select the proper signal generator step attenuator setting while in internal ALC mode.

For example, to set the level to 0 dBm, rotate the signal generator display Knob until “0 dBm” is shown on the microwave amplifier’s display.

**7. Select the **ALC DIODE** softkey.**

**8. Set the desired RF output amplitude at the output of the millimeter source module as displayed on the microwave amplifier.**

The display on the HP 8349B microwave amplifier shows the power level at the output of the millimeter source module to within  $\pm 2$  dB. Remember to look at the display on the microwave amplifier, *not* the signal generator, when adjusting the RF output amplitude. For example, to set the level to 0 dBm, select the AMPTD function and rotate the signal generator display Knob until “0 dBm” is shown on the microwave amplifier’s display.

---

**Note**

The Knob resolution can be changed using the Modify Step functions. However, the multiplied signals frequency resolution is further limited due to the FREQUENCY MULTIPLIER function. For instance, if the FREQUENCY MULTIPLIER is set to 3, and the signal generator resolution is 1 kHz, the resulting resolution is 3 kHz.

---

**Related Tasks**

- To Generate a CW Signal

## To Use External Diode Detector Leveling

External diode detector leveling is useful when you desire leveled RF output amplitude from the signal generator at a point other than the RF OUTPUT connector.

External diode detector leveling uses the following external equipment.

| Equipment  | Requirements  |
|--|---|
| Diode Detector                                     | Must be specified for use at the desired signal generator output frequency and must produce >1mV of ALC voltage for the power levels present at the sampling point. |
| Power Splitter<br><i>or</i><br>Directional Coupler | Must be specified for use at the desired signal generator output frequency.   |
| Power Meter<br><i>(optional)</i>                   | None.   |
| Power Sensor<br><i>(optional)</i>                  | Must be capable of measuring power at the frequency and level present at the sampling point in the leveling loop.   |

**Note** The power meter and power sensor are not required, but are helpful when adjusting the signal generator output power for the desired power level at the sampling point.

In addition, you must supply the cables and adapters necessary to connect the equipment.

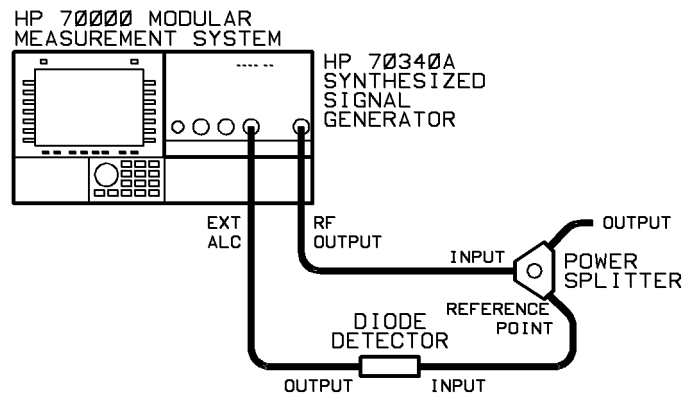

**Figure 3-12. External Diode Detector Leveling Setup**

1. Connect the equipment as shown in Figure 3-12.
2. Set the desired output signal using the **CW FREQ** function and any modulation.
3. Turn on internal leveling by selecting **Amptd** and then **ALC INT**.
4. Adjust the signal generator RF output amplitude so that the desired power at the sampling point is attained.

For example, assume that you are using a power splitter and that you want  $-5$  dBm at the output of the splitter. In this case, you must set the power at the sampling (reference) point (the power splitter's other outputs) to  $-5$  dBm. Perform the following procedure to set the power at the sampling (reference) point to  $-5$  dBm.

- a. Disconnect the diode detector from the power splitter and temporarily connect the power meter and sensor to the sampling point.
- b. Select the **AMPTD** function.
- c. Rotate the Knob on the MMS display until the power meter display reads  $-5$  dBm. (Disregard the MMS display amplitude reading.)

Note that you can change the Knob resolution using the Modify Step functions.

- d. Disconnect the power meter and sensor from the sampling point and reconnect the diode detector to it.

5. **Select the **ALC DIODE** softkey to enable external diode leveling.**

When the ALC DIODE function is enabled, the signal generator enters the external diode detector leveling mode. In this mode, power is held constant at the sampling point, regardless of gain changes in the signal path between the signal generator RF OUTPUT connector and the sampling point.

---

**Notes**

1. When you select the ALC DIODE function, the signal generator output power may change. Therefore, it is recommended that you check the sampled power and readjust it, if necessary.
2. External diode detector leveling does not provide temperature compensation; thus, amplitude recalibration may be required in environments that are not temperature stabilized.

---

Diode detector leveling requires manual operation of the equipment. The following command is used to turn on diode detector leveling via HP-IB.

```
OUTPUT 719; "POW:ALC:SOUR DIOD"
```

**Related Tasks**

- To Generate a CW Signal
- To Use External Power Meter Leveling

## To Use External Power Meter Leveling

External power meter leveling is useful when you desire leveled RF output amplitude from the signal generator at a point other than the RF OUTPUT connector.

External power meter leveling requires the following external equipment.

| Equipment  | Requirements  |
|--|---|
| Power Meter  | Must have a recorder output and range hold capability.  |
| Power Sensor                                       | Must be capable of measuring power at the frequency and level present at the sampling point in the leveling loop. |
| Power Splitter<br><i>or</i><br>Directional Coupler | Must be specified for use at the desired signal generator output frequency.                                       |

In addition, you must supply the cables and adapters necessary to connect the equipment.

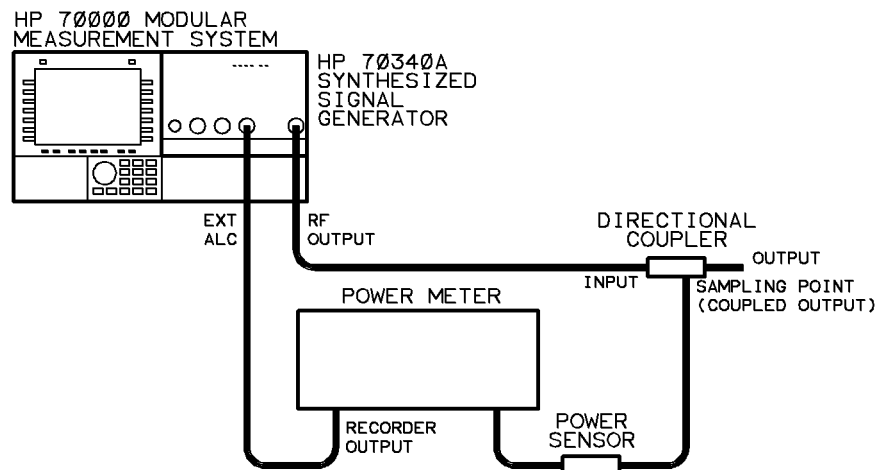

Figure 3-13. External Power Meter Leveling Setup

1. Connect the equipment as shown in Figure 3-13.
2. Generate the desired output signal using the **CW FREQ** function and any modulation.
3. If the RF output is off, turn it on by selecting the **Amptd** menu and then **AMPTD On Off**.
4. Select the **ALC INT** softkey to enable internal leveling.
5. Select the auto-range mode on the power meter.
6. Modify the signal generator output amplitude so that the power meter display indicates the power desired at the sampling point.

For example, assume that you are using a directional coupler that has a coupling factor of 22 dB and you want +5 dBm at the output of the coupler. In this case, you must set



the power at the sampling point (the coupled output) to  $-17$  dBm. Perform the following procedure to set the power at the sampling point to  $-17$  dBm.

- a. Select the **AMPTD** function.
- b. Rotate the Knob on the signal generator until the power level displayed on the power meter is  $-17$  dBm. (Disregard the power level shown on the signal generator display.)

Note that you can change the resolution of the Knob using the Modify Step functions.

7. **Select range hold (select range) mode on the power meter.**
8. **Select the **PWR MTR READING** softkey on the signal generator.**

The display data entry box indicates:

```
Power Meter Reading (Range-Hold)
XXXdBm
```

*where XXX is the last “range-hold” power meter reading that was entered.*

9. **Enter the power shown on the power meter display into the signal generator using the numeric keypad and **dBm** softkey.**

For example, if the power meter currently reads  $-17$  dBm, perform the following steps to enter  $-17$  dBm into the signal generator:

- a. Type **[−] [1] [7]** on the signal generator numeric keypad.
- b. Terminate the power meter value entry by selecting the **dBm** softkey.

10. **Select the **ALC PWR MTR** softkey on the signal generator.**

The display indicates:

```
ALC PWR MTR
```

When the ALC PWR MTR function is selected, the signal generator enters the external power meter leveling mode. In this mode, power is leveled at the sampling point regardless of gain changes in the signal path between the signal generator RF OUTPUT connector and the sampling point.

## Programming Example

In the following example, external power meter leveling will be used to level a CW signal (external power meter leveling can be used to level signals with any modulation combination except pulse modulation; a CW signal is used here only as an example). The signal will have a frequency of 4.2 GHz with an initial output amplitude of  $-23.3$  dBm.

To program the signal generator for external power meter leveling, connect the equipment as shown in Figure 3-13 and then run the following program.

---

### Notes

1. Since external power meter leveling is interactive initially, the program prompts you to enter power level values until the desired power is attained at the sampling point.
2. External power meter leveling can be done with any power meter having a recorder output, however, since different power meters are programmed

using different commands, the HP 437B power meter has been chosen for this example.

---

|  |   |
|--|---|
| 10 PRINT "CHOOSE THE POWER LEVEL<br>DESIRED AT THE SAMPLING POINT<br>IN DBM (-23.3 FOR EXAMPLE)" |   |
| 20 ENTER KBD; Meter_power  | <i>Enters the desired power level into variable "Meter_power."</i>      |
| 30 OUTPUT 719; "*RST"  | <i>Presets the signal generator.</i>                                    |
| 40 OUTPUT 719; "FREQ 4.2GHZ"   | <i>Sets the output frequency to 4.2 GHz.</i>                            |
| 50 OUTPUT 719; "POW:LEV ";Meter_power  | <i>Sets the output amplitude .</i>                                      |
| 60 OUTPUT 713; "*RST"  | <i>Presets the power meter.</i>   |
| 70 OUTPUT 713; "LG"  | <i>Changes power meter units from Watts to dBm.</i>                     |
| 80 OUTPUT 713; "FR 4.2 GZ"   | <i>Sets frequency at power meter to 4.2 GHz.</i>                        |
| 90 OUTPUT 713; "RA"  | <i>Selects Auto Range on the power meter.</i>                           |
| 100 WAIT 5   | <i>Waits 5 seconds for the power meter to settle.</i>                   |
| 110 OUTPUT 713; "RH"   | <i>Selects Range Hold on the power meter.</i>                           |
| 120 OUTPUT 713; "TR2"  | <i>Sets power meter to trigger with delay.</i>                          |
| 130 WAIT 5   | <i>Waits 5 seconds for the power meter to settle.</i>                   |
| 140 ENTER 713; Meter_reading   | <i>Reads power from power meter into variable "Meter_reading."</i>      |
| 150 OUTPUT 719; "POW:ALC:PMET ";Meter_reading  | <i>Reads the initial power meter reading into the signal generator.</i> |
| 160 OUTPUT 719; "POW:ALC:SOUR PMET"  | <i>Enables external power meter leveling.</i>                           |
| 170 OUTPUT 713; "TR3"  | <i>Sets power meter to free run trigger.</i>                            |
| 180 OUTPUT 719; "POW:LEV ";Meter_power   | <i>Sets the output amplitude .</i>                                      |
| 190 PRINT "END OF PROGRAM"   |   |
| 200 END  |   |

## Related Tasks

- To Generate a CW Signal
- To Use External Diode Detector Leveling

---

## To Generate Simultaneous Log AM and Pulse Modulation

You can generate simultaneous logarithmic AM and pulse modulation by applying a voltage waveform to the signal generator **EXT AM** connector while simultaneously applying external (or, if your instrument has Option 1E2, internal or gated pulse) modulation. The resulting signal at the signal generator **RF OUTPUT** connector is useful for antenna scan patterns in radar receiver test applications.

The procedure that follows shows how to generate an antenna scan pattern.

Generating simultaneous log AM and pulse modulation requires the following external equipment.

| Equipment   | Requirements   |
|---|--|
| Variable Voltage Source or Arbitrary Waveform Generator | Must be capable of producing the desired antenna scan waveform with an amplitude varying from a minimum of 0 volts to a maximum up to +6 volts, depending on the amount of dynamic range required in the antenna scan pattern. |
| Pulse Generator   | Must be capable of sourcing a TTL level signal into a 50Ω load.  |

---

### Caution

1. The antenna scan waveform must never exceed the range of +15.5V to -15.5V or damage to the **EXT AM** input can occur. The input impedance of the **EXT AM** connector is 5 kΩ. The pulse modulating signal must never exceed the range of +5.5V to -0.5V or damage to the **EXT PULSE** input can occur.
2. If your instrument has Option 1E2, the pulse modulating signal must never exceed the range of +5.5V to -0.5V or damage to the **PULSE/TRIG, GATE IN** input can occur.

- 
1. Connect the equipment as shown in Figure 3-14:

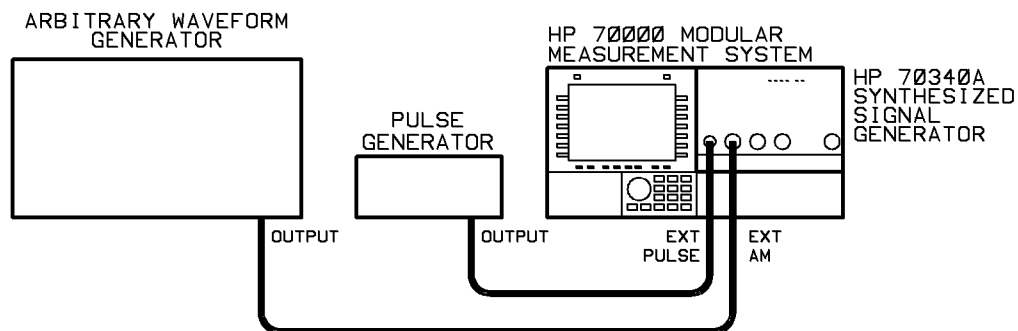

Figure 3-14. Antenna Scan Equipment Setup

2. Set the pulse generator characteristics (PRF and width ) as required for your particular application.

3. Set the signal generator carrier frequency for the pulsed RF using the **Freq** menu and **CW FREQ**.
4. Set the power level required at the peak of the main lobe of the scan using the **Amptd** menu and **AMPTD**.
5. Select the **ALC INT** softkey to enable internal leveling.
6. If the RF output is currently turned off, press the **AMPTD On Off** softkey to turn it on.
7. Choose external pulse modulation (or a type of internal pulse modulation if your instrument has Option 1E2), and set the pulse characteristics as required for your particular application.

If your instrument does not have Option 1E2, select **Modultn** and then **PULSE On Off** and **PULSE Nml Inv** to choose between normal and inverted external pulse modulation.

If your instrument has Option 1E2, you can use one of six pulse modulation modes, depending upon your application. You can access the six modes by selecting **Modultn** and then **pulse modultn**. The six pulse modes are internal, external normal, external inverted, gated, doublet, and internal triggered pulse modulation.

8. Select **Modultn** and then **LOG AM On Off** to turn logarithmic amplitude modulation on.

When logarithmic amplitude modulation is turned on, the display shows: **AM ON**.

9. If FM is turned on, select the **FM On Off** softkey to turn it off.

When frequency modulation is turned off, the display shows: **FM OFF**.

10. Set the arbitrary waveform generator or variable voltage source to produce a waveform with amplitude characteristics that achieve an antenna scan with the desired dynamic range.

The antenna scan waveform should vary from a positive voltage to zero volts. For every +1 volt at the **EXT AM** connector, the RF output is attenuated by 10 dB. For example, the waveform shown in Figure 3-15 applied to the **EXT AM** connector causes the antenna scan pattern shown in Figure 3-16 to appear at the signal generator **RF OUTPUT** connector (provided the output level has been set to  $-20$  dBm).

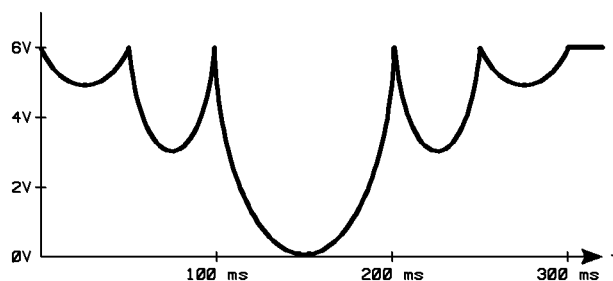

**Figure 3-15. Example Antenna Scan Input**

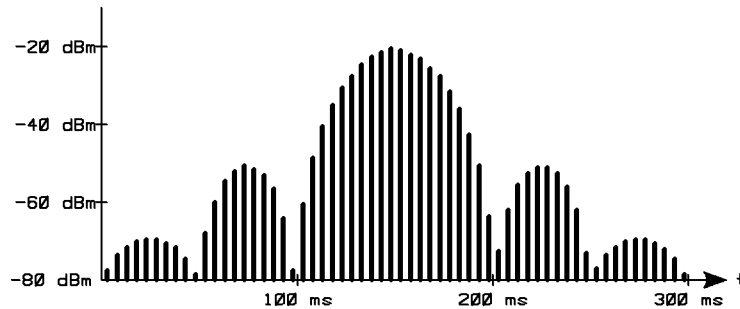

**Figure 3-16. Example Modulated Antenna Scan Pattern**

When the signal generator is used to generate antenna scan patterns, the pulsed signal does not have any duty cycle limitations.

---

**Note** If the signal generator pulsed RF output is to be connected to average power sensitive circuitry, refer to PWR LIM On/Off in the “Menus and Functions” chapter of this manual.

---

### Programming Example

In the following example, an antenna scan pattern will be generated using simultaneous logarithmic AM and external pulse modulation. A carrier frequency of 2.3 GHz at a peak main lobe power level of  $-20$  dBm will be used.

To program the signal generator to generate the antenna scan pattern explained above, connect the equipment as shown in Figure 3-14. Set the scan generator to produce the scan waveform shown in Figure 3-15, and then run the following program.

|  |  |
|--|--|
| 10 OUTPUT 719; "*RST"                        | <i>Sets the instrument to preset state.</i>  |
| 20 OUTPUT 719; "PULM:SOUR EXT"               | <i>Sets pulse source to external.</i>  |
| 30 OUTPUT 719; "PULM:EXT:POL <u>NORM INV</u> | <i>SELECTS EITHER NONINVERTED (NORMAL) OR INVERTED EXTERNAL PULSE MODULATION</i>                   |
| 40 OUTPUT 719; "PULM:STAT ON"                | <i>Turns pulse modulation on.</i>  |
| 50 OUTPUT 719; "FREQ 2.3GHZ"                 | <i>Sets the carrier frequency to 2.3 GHz.</i>  |
| 60 OUTPUT 719; "POW:LEV -20DBM"              | <i>Sets the output amplitude to <math>-20</math> dBm (this is the peak main lobe power level).</i> |
| 100 OUTPUT 719; "AM:STAT ON"                 | <i>Turns logarithmic amplitude modulation on.</i>  |
| 110 OUTPUT 719; "OUTP:STAT ON"               | <i>Turns the RF output on.</i>   |
| 120 OUTPUT 719; "POW:ALC:SOUR INT"           | <i>Enables internal leveling.</i>  |
| 130 END                                      |  |

### Related Tasks

- **PWR LIM On Off**
- To Generate Internal Pulse Modulation
- To Generate External Pulse Modulation
- To Generate Gated Pulse Modulation

---

## To Use the Flatness Correction Routine

When the FLATNESS CORRECTION routine is on, the signal generator performs a calibration process that corrects for external losses or power variations in an external signal path. In order to use FLATNESS CORRECTION, the signal generator must first run the CALIBRATE FLATNESS CORRECTION routine. During the CALIBRATE FLATNESS CORRECTION routine, an HP 437B, HP 438A, HP 70100A, or a SCPI compatible power meter, that is under control of the signal generator, measures power variations at the output of the external signal path over a user-defined frequency range. The signal generator then reads back the power level data from the power meter and creates a table of correction values for each frequency point (the flatness correction table). The flatness correction table is automatically stored in one of four non-volatile memory registers. Up to four flatness correction tables can be stored for later use.

When FLATNESS CORRECTION is on, the flatness correction table adjusts the signal generator output power (to compensate for losses or gains) to provide constant leveled power at the external port.

---

**Note** If you use the FLATNESS CORRECTION routine when the RF output is leveled internally, devices external to the signal generator must be linear (must have a 1 dB to 1 dB transfer function).

---

Using the CALIBRATE FLATNESS CORRECTION routine requires the following external equipment:

| Equipment   | Requirements   |
|---|--|
| HP 437B Power Meter or<br>HP 438A Power Meter or<br>HP 70100A Power Meter or<br>SCPI compatible power meter<br>Power Sensor | Must be compatible with the chosen power meter. Must be capable of measuring power at the frequencies and levels present at the output of the signal path being leveled. |

In addition, you must supply the cables and adapters necessary to connect the equipment.

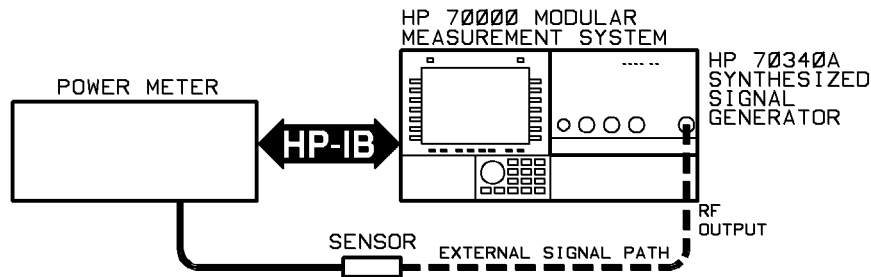

Figure 3-17. Flatness Correction Equipment Setup

1. Connect the equipment as shown in Figure 3-17:
2. Select the `Amptd` menu so that the `AMPTD` function is selected.
3. Adjust the signal generator AMPLITUDE to a level near the center of your power sensor range.
4. If the RF output is currently turned off, press the `AMPTD On Off` softkey to turn it on.
5. Select the register where the flatness correction data is to be stored.

For example, to store data in FLATNESS DATA 2 register, perform the following steps:

- a. Select the `flatnes corrctn` menu.
  - b. Select `FLATCOR On Off` so that Off is underscored.
  - c. Select `FLATNES DATA 2` so that it is underscored.
6. Select the external power meter to be used during the flatness correction routine.
  7. Enter the power meter address into the signal generator so that the instrument can address the power meter during the flatness correction routine.

For example use the following steps to set the address to 23.

- a. Select the `PWR MTR ADDRESS` function.
  - b. Type `23` on the signal generator numeric keypad.
  - c. Select the `ENTER` softkey in order to terminate the entry.
8. Select the start frequency for data collection by pressing the `←` key and then the `START FREQ` softkey.

When the START FREQ function is selected, the display data entry box indicates:

```
Cor Start Frequency
X.XXXXXXXXXXGHz
where X.XXXXXXXXXX is the current start frequency.
```

9. Enter the desired start frequency.

### 3-36 Generating Signals

For example, use the following procedure to set the flatness correction start frequency to 3.5 GHz.

- a. Type **3** **.** **5** on the signal generator numeric keypad.
- b. Terminate the flatness correction start frequency by selecting the **GHz** softkey.

10. **Select the **STOP FREQ** softkey in order to enter the flatness correction stop frequency.**

The display data entry box indicates:

Cor Stop Frequency

X.XXXXXXXXXGHz

*where X.XXXXXXXXX is the current stop frequency.*

11. **Enter the desired stop frequency.**

For example, use the following procedure to set the flatness correction stop frequency to 9.75 GHz.

- a. Type **9** **.** **7** **5** on the signal generator numeric keypad.
- b. Terminate the stop frequency by selecting the **GHz** softkey.

12. **Select the **POINTS** function in order to enter the number of points to be calibrated.**

The display indicates:

Set number of points

XX

*where XX is the current number of points.*

13. **Enter the desired number of points.**

Note that the start and stop frequencies are include in the number of points.

For example, use the following procedure to set the number of points to 100.

- a. Type **1** **0** **0** on the signal generator numeric keypad.
- b. Terminate the number of points entry by selecting the **ENTER** softkey.

14. **Select the **CALIB FLATCOR** softkey.**

At this point, the display returns the CALIB FLATCOR function and the previous menu function so that you have the opportunity to abort the flatness correction routine and return to the previous menu if you decide *not* to run the routine.

15. **Select the **CALIB FLATCOR** softkey (again) in order to run the calibration routine.**

As the signal generator runs the routine, it displays each frequency and power meter reading. Note that the signal generator sends the power meter each frequency point so that the power meter can use the correct sensor calibration factor to determine power level. Thus, for highest accuracy, the correct calibration factors for your sensor should be entered into the power meter.

When the signal generator completes the CALIBRATE FLATNESS CORRECTION routine, the display returns to the flatness correction menu.

16. **Turn on **FLATNESS CORRECTION** after the routine is finished running by selecting **MORE 2 of 2** and then **FLATCOR On Off** so that **On** is underscored.**



The signal generator now uses the flatness correction data to adjust the RF output amplitude so that the **displayed power level is the level at the external port, not at the RF Output connector**. The correction is active **for any power level** and any frequency within the calibrated frequency range.

### 17. Disconnect the power meter and power sensor from the external signal path.

#### Notes

1. The data stored in non-volatile memory is only be valid for the current external signal path. If the external signal path is changed, the CALIBRATE FLATNESS CORRECTION routine must be run again.
2. You can abort the CALIBRATE FLATNESS CORRECTION while it is running by selecting the **ABORT** softkey.

### Programming Example

During the flatness correction routine, the signal generator must act as a controller. Therefore, it is not possible for another system controller to initiate a flatness correction routine. The following program can be used to gather flatness correction data externally, then load the collected data into one of the signal generator flatness correction tables.

|   |   |
|---|---|
| 10 DIM Frequencies(1:401)   | <i>Dimensions frequency array.</i>  |
| 20 DIM Losses(1:401)  | <i>Dimensions correction factor array.</i>                                |
| 30 signal generator=719   | <i>Sets signal generator address variable to 719.</i>                     |
| 40 Power_meter=713  | <i>Sets power meter address variable to 719.</i>                          |
| 50 PRINT "CHOOSE THE START FREQUENCY IN GHZ (1.654321 FOR EXAMPLE)"       | <i>Enters start frequency into variable Start_freq.</i>                   |
| 60 ENTER KBD;Start_freq   |   |
| 70 PRINT "CHOOSE THE STOP FREQUENCY IN GHZ (15.123456 FOR EXAMPLE)"       | <i>Enters stop frequency into variable Stop_freq.</i>                     |
| 80 ENTER KBD;Stop_freq  |   |
| 90 PRINT "CHOOSE THE NUMBER OF POINTS (2 TO 401)"                         | <i>Enters number of points into variable Points.</i>                      |
| 100 ENTER KBD;Points  |   |
| 110 PRINT "CHOOSE THE LEVEL CORRECTION TABLE TO STORE DATA INTO (1 TO 4)" | <i>Enters correction table number into variable Table_num.</i>            |
| 120 ENTER KBD;Table_num   |   |
| 130 PRINT "CHOOSE THE SIGNAL GENERATOR POWER LEVEL TO USE DURING ";       | <i>Enters power level into variable Power_lev.</i>                        |
| 140 PRINT "THE LEVEL CORRECTION"  |   |
| 150 PRINT "(-3.32 FOR EXAMPLE)"   |   |
| 160 ENTER KBD;Power_level   |   |
| 170 OUTPUT signal generator; "*RST"                                       | <i>Presets the signal generator.</i>                                      |
| 180 OUTPUT signal generator; "POW ";Power_level                           | <i>Sets signal generator power level to the entered value.</i>            |
| 190 OUTPUT Power_meter; "*RST"  | <i>Presets the power meter.</i>   |
| 200 OUTPUT Power_meter; "FM 32 EN"  | <i>Sets number of averages.</i>   |
| 210 OUTPUT Power_meter; "TRO"   | <i>Sets power meter to trigger hold mode.</i>                             |
| 220 Step_freq=(Stop_freq-Start_freq)/(Points-1)                           | <i>Calculates the frequency step.</i>                                     |
| 230 Current_freq=Start_freq   | <i>Sets first frequency in array to start frequency.</i>                  |
| 240 FOR I=1 TO Points   | <i>Stores current frequency in array.</i>                                 |
| 250     Frequencies(I)=Current_freq                                       |   |
| 260     OUTPUT signal generator; "FREQ ";Current_freq;" GHZ"              | <i>Sets signal generator frequency to the current frequency in array.</i> |
| 270     OUTPUT Power_meter; "FR ";Current_freq;" GZ"                      | <i>Sets power meter frequency to the current frequency in array.</i>      |
| 280     OUTPUT Power_meter; "TR2"   | <i>Sets power meter to trigger with delay.</i>                            |
| 290     WAIT 5  | <i>Waits five seconds for power meter to settle.</i>                      |

|   |   |
|---|---|
| <pre> 300     ENTER Power_meter;Meter_reading 310     Losses(I)=Power_level-Meter_reading 320     Current_freq=Current_freq+Step_freq  330 NEXT I 340 OUTPUT signal generator; "MEM:TABL:SEL       FDAT";TRIM\$(VAL\$(Table_num)) 350 ! 360 ! Store frequencies 370 ! 380 OUTPUT signal generator; "MEM:TABL:FREQ "; 390 FOR I=1 TO Points 400     OUTPUT signal generator;Frequencies(I);"GHZ"; 410     IF I&lt;Points THEN OUTPUT signal generator;","; 420 NEXT I 430 OUTPUT signal generator USING "/" 440 ! 450 ! Store losses 460 ! 470 OUTPUT signal generator; "MEM:TABL:LOSS "; 480 FOR I=1 TO Points 490     OUTPUT signal generator;Losses(I); 500     IF I&lt;Points THEN OUTPUT signal generator;","; 510 NEXT I 520 OUTPUT signal generator USING "/" 530 PRINT "END OF PROGRAM" 540 END </pre> | <p><i>Enters current power meter reading into variable Meter_reading.</i></p> <p><i>Stores the correction factor in array.</i></p> <p><i>Increments current frequency to the next frequency in the table.</i></p> <p><i>Selects a table to store data to.</i></p> <p><i>Commands signal generator to load following frequency points into table.</i></p> <p><i>Adds a frequency point into the table.</i></p> <p><i>Adds a data separator (comma).</i></p> <p><i>Adds a line feed.</i></p> <p><i>Commands signal generator to load following correction factors into table.</i></p> <p><i>Adds a correction factor into the table.</i></p> <p><i>Adds a data separator (comma).</i></p> <p><i>Adds a line feed.</i></p> |
|---|---|

## Related Tasks

- To Use Previously Stored Flatness Correction Data

---

## To Use Previously Stored Flatness Correction Data

When the CALIBRATE FLATNESS CORRECTION routine is run, the signal generator creates a table of correction values for each frequency point in the table. Up to four flatness correction tables can be stored in the signal generator memory. If the current signal path at the signal generator output (the external signal path) is identical to the external signal path for which a CALIBRATE FLATNESS CORRECTION routine has been run, the flatness correction table can be recalled from memory and be used at a later time.

1. **Verify that the current external signal path is correct for the flatness correction table that you want to recall from memory and use.**

The current external signal path must be identical to the external signal path that was calibrated and stored in the flatness correction table that you wish to recall. If the current signal path is different, the data can cause inaccurate output amplitudes at the external port.

2. Select the `Amptd` menu and then the `flatnes corrctn` menu.
3. Select `FLATNES DATA x` where `x` is the register (1 through 4) from which you wish to recall data.
4. Select `FLATCOR On Off` so that `On` is underscored in order to enable the signal generator to use the flatness correction data when determining the output amplitude.

### Programming Example

In the following example, flatness correction data is recalled from flatness correction register number four and used to level the signal generator output amplitude .

To program the signal generator to level the output amplitude using the flatness correction data in register number four, first, ensure that the current external signal path is correct for the flatness correction data stored in register number four, and, then, run the following program.

```
10 OUTPUT 719; "CORR:CSET FDATA4"    Selects the flatness correction table in register  
                                     number four.  
20 OUTPUT 719; "CORR:STAT ON"        Enables all corrections  
30 OUTPUT 719; "CORR:CSET:STAT ON"   Turns flatness correction on.  
40 END
```

### Related Tasks

- To Use the Flatness Correction Routine

---

## If You Encounter a Problem

If you have a problem generating signals with the signal generator, check the following list of commonly encountered problems and troubleshooting procedures. If the problem involves data entry or the display, check the Chapter 2 section entitled “If You Encounter a Problem.” If the problem that you encounter is not in the following list or in Chapter 2, refer to the Troubleshooting section of the *Installation and Verification Manual* for your particular MMS display module, or contact the nearest Hewlett-Packard office for service.

### If the UNLEVELED LED is on:

- Check the leveled power specification to make sure that you have not exceeded the specification.
- Check that the ALC DIODE or ALC POWER METER functions are not inadvertently on.

### If the ERR LED is on:

Refer to the procedure, “To Check the Error Queue”, in Chapter 2, “Performing Fundamental Operations.”

### If there is no signal at the RF Output connector:

- Check that the **AMPTD On Off** function is On.

The AMPTD On/Off function is under the Amplitude menu. The display also indicates whether the function is on or off through the message **RF ON.** or **RF OFF.**

- Check the external modulation signal for problems.

Note that if pulse modulation is on in standard non-inverted operation, but, there is no input signal at the **EXT PULSE** connector, the RF output signal will turn off.

### If the signal generator modulation is on and the signal is distorted:

- Check that the external modulating signal source is within the signal generator specifications.

### If the RF Output connector signal does not appear to be phase locked to the external reference:

- Check that the external reference is within signal generator specifications. Refer to “Specifications and Options”, Chapter 4.
- Check that **FM TYPE AC DC** is set to AC.

FM TYPE AC DC is found under the Miscellaneous menu. “AC” is underscored when AC FM is on.



## Specifications and Options

---

This section contains the specifications, supplemental characteristics, and warranty, electrical, and documentation options for both the HP 70340A and the HP 70341A .

Refer to the entry “Accessories (included)” in the “Front and Rear Panel” chapter for the accessories and documentation which are included with the HP 70340A shipment. Refer to the entry “Accessories (not included)” for accessories such as cables which may be required for certain signal generator and frequency extension module applications. Similarly, the “Reference” chapter of the *HP 70341A Installation Guide* contains the accessories and documentation which are included with the frequency extension module.

---

## HP 70340A and HP 70341A Specifications

Specifications describe the instruments warranted performance over the 0° to 55° temperature range unless otherwise noted. Supplemental characteristics, *indicated by italics*, are intended to provide information useful in estimating instrument capability in your application by describing typical, but not warranted, performance.

### Frequency

**Range:** HP 70340A Modular Signal Generator, 1.0 to 20.0 GHz

HP 70341A Frequency Extension Module, 10 MHz to 1 GHz

HP 70341A can only be used in combination with the HP 70340A.

**Resolution:** 1 kHz (1 Hz with Option 1E8)

**Stability (with external high stability timebase):**

**Aging Rate:** same as external reference.

Temperature Effects: same as external reference.

**Stability (without external high stability timebase):**

*Aging Rate:  $<1.0 \times 10^{-8}$ /day after 72-hours at  $25^{\circ}C \pm 10^{\circ}C$*

*Temperature Effects:  $<5 \times 10^{-6}$  over 0 to 55° C, referenced to 25° C*

*Frequency Switching Time:  $< 50$  ms to within 1 kHz, 1 - 20 GHz.*

*$<100$  ms to within 1 kHz, 10 MHz - 1 GHz.*

## RF Output

Maximum Leveled Output Power:

| Frequency  | Standard | with Option 1E1 |
|------------|----------|-----------------|
| 0.01–1 GHz | +13 dBm  | +13 dBm         |
| 1–18 GHz   | +11 dBm  | +10 dBm         |
| 18–20 GHz  | +10 dBm  | +8 dBm          |

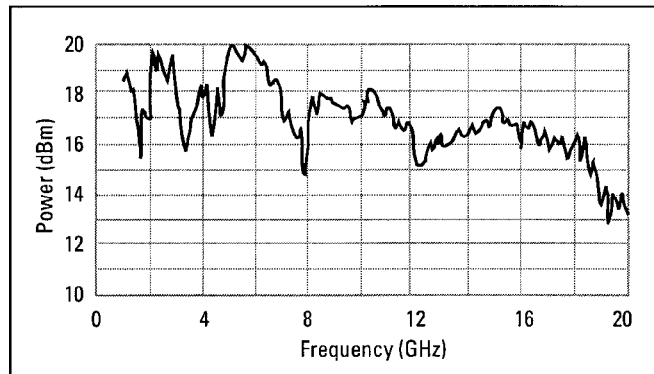

Typical maximum available output power from 1 to 20 GHz, at 25°C with output step attenuator (Option 1E1) installed.

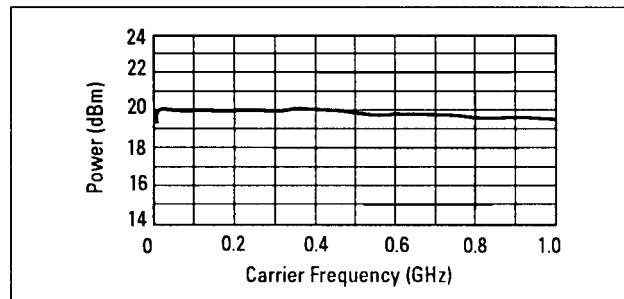

Typical maximum available output power from 0.01 to 1 GHz at 25°C.

Display Resolution: 0.01 dB

Minimum Leveled Output Power (without Option 1E1): -4 dBm

Minimum Leveled Output Power (with Option 1E1): -90 dBm

Accuracy: (-4 dBm to specified maximum leveled output power)

10 MHz to 50 MHz:  $\pm 1.3$  dB

50 MHz to 20 GHz  $\pm 1.0$  dB



**Accuracy:** (over all specified temperatures and power levels)

10 MHz to 50 MHz:  $\pm 2.3$  dB

50 MHz to 20 GHz:  $\pm 2.0$  dB

The use of Type-N RF connectors above 18.0 GHz degrades specification typically by 0.2 dB.

**Flatness:**  $\pm 0.5$  dB. The use of Type-N RF connectors above 18.0 GHz degrades specification typically by 0.2 dB.

*Level Switching Time: <15 ms (without step attenuator range change. Attenuator range changes occur at  $-4$  dBm,  $-14$  dBm,  $-24$  dBm, etc.)*

*Output SWR: <2.0 : 1 nominal*

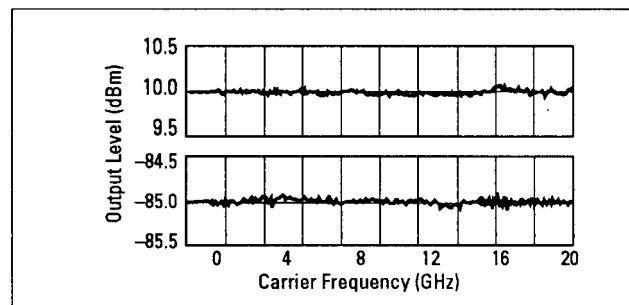

Typical output level accuracy and flatness at +10 and -85 dBm

## Spectral Purity

SSB Phase Noise (dBc/Hz):

### Offsets

| Carrier Freq. | 100 Hz | 1 kHz | 10 kHz | 100 kHz |
|---------------|--------|-------|--------|---------|
| 500 MHz       | -70    | -86   | -103   | -119    |
| 2 GHz         | -66    | -74   | -91    | -107    |
| 10 GHz        | -69    | -75   | -79    | -101    |
| 18 GHz        | -63    | -70   | -73    | -99     |

Phase noise decreases 6 dB/octave below 500 MHz and reaches a floor of  $<-140$  dBc/Hz.

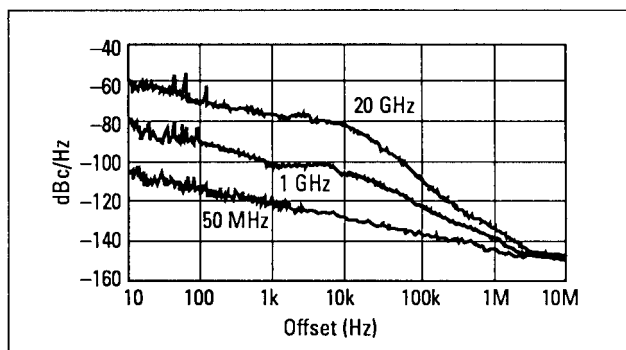

**Typical single-sideband phase noise at 50 MHz, 1 GHz and 20 GHz, 25°C, CW mode. Offsets less than 100 Hz require use of external high stability timebase.**

**Harmonics:**  $< -55$  dBc at output levels  $< +6$  dBm, 0.01 to 20 GHz

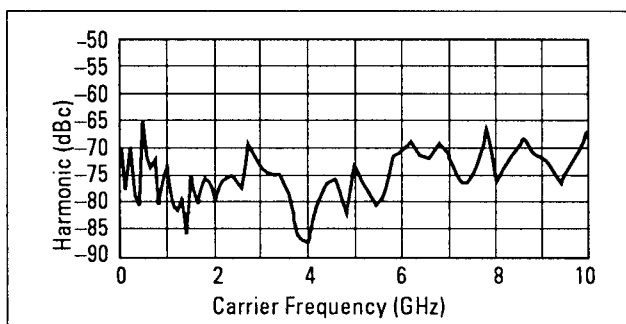

**Typical 2nd harmonic levels measured at output power of +6 dBm**

**Non-Harmonic Spurious ( $\geq 3$  kHz):**  $< -60$  dBc (includes power supply and frequency synthesis spurious).

*Non-Harmonic Spurious ( $< 3$  kHz):*  $< -50$  dBc

*Sub-Harmonics:* None

*Residual FM:*

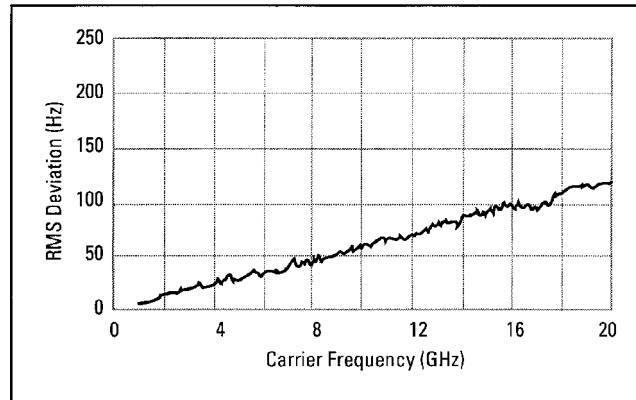

**Typical residual FM measured in 50 Hz - 15 kHz bandwidth, CW mode.**

*At 1 GHz, <15 Hz in 50 Hz - 15 kHz bandwidth.*

*Residual FM decreases 6 dB per octave below 1 GHz.*

*AM Noise Floor: (at 0 dBm and offsets greater than 5 MHz from carrier) <-150 dBm/Hz, 1 - 20 GHz.*

*<-140 dBm/Hz, 0.01 - 1 GHz.*

## Modulation

| CARRIER FREQUENCY                 | <25 MHz                     | 25 - <64 MHz | 64 - <128 MHz | 128 - <500 MHz | 500 - <1000 MHz                      | 1 - 20 GHz                   |
|-----------------------------------|-----------------------------|--------------|---------------|----------------|--------------------------------------|------------------------------|
| Minimum Pulse Width               | <1 $\mu$ s                  |              | <100 ns       |                | <25 ns<br><i>Typically &lt;10 ns</i> |                              |
| Rise/Fall Time                    | <500 ns                     | <350 ns      | <50 ns        | <35 ns         | <20 ns                               | <10 ns                       |
| Video Feedthrough                 | <2 mV peak-to-peak at 0 dBm |              |               |                |                                      | <20 mV peak-to-peak at 0 dBm |
| Pulse Width Compression           | $\pm 150$ ns                |              | $\pm 15$ ns   |                | $\pm 5$ ns                           |                              |
| Pulse Delay (Video out to RF out) | <1 $\mu$ s                  |              | <200 ns       |                | <125 ns                              | <100 ns                      |

## Pulse Modulation

**On/Off Ratio:** > 80 dB

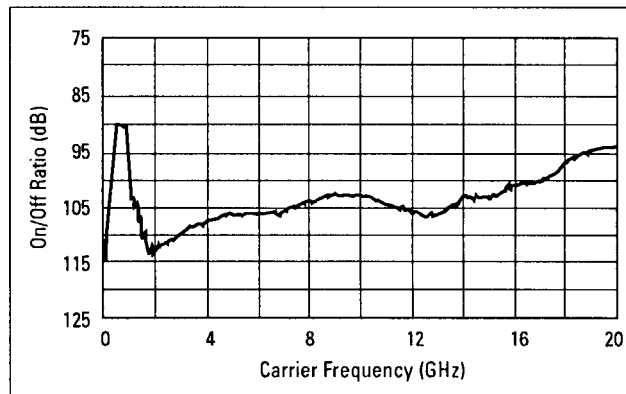

**Typical pulse modulation on/off ratio at +8 dBm**

*Maximum Pulse Repetition Frequency:* > 3 MHz

*Minimum Pulse Duty Cycle:* No restrictions on duty cycle.

*Pulse Level Accuracy (relative to CW):*  $\pm 1.0$  dB

*Pulse Overshoot:* < 10%

*Input Impedance:* 50 $\Omega$  nominal; TTL drive levels

*Maximum Leveled Output Power in Pulse Mode (relative to CW):*

-0.5 dB

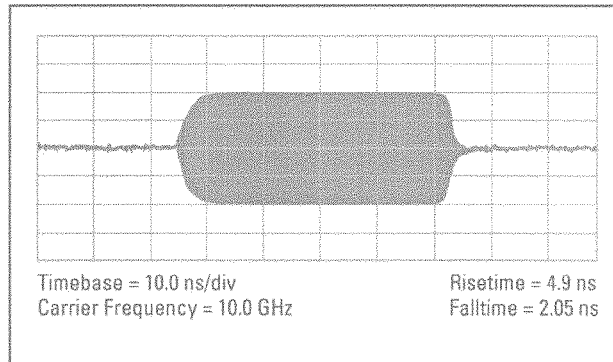

**Typical pulse modulation envelope illustrates the fast rise and fall times, excellent flatness and pulse fidelity of the HP 70340A**

#### **Internal Pulse Source (Option 1E2)**

**Pulse Source Modes:** Free-run, triggered with delay, doublet and gated. Triggered with delay, doublet and gated require external trigger source.

**Pulse Repetition Frequency:** 3 Hz to >3 MHz

**Pulse Repetition Interval (PRI):** 300 ns to 419 ms

**Pulse Width ( $T_w$ ):** 25 ns to 419 ms

**Variable Pulse Delay (free-run mode,  $T_d$ ):**  $\pm 419$  ms from sync pulse to video modulation

**Variable Pulse Delay (triggered with delay & doublet modes,  $T_d$ ):**

225 ns to 419 ms with  $\pm 25$  ns jitter

**Pulse Width/Delay/PRI Resolution:** 25 ns

*Pulse Delay (Video to RF,  $T_m$ ):* Nominally, <20 ns, 1 to 20 GHz

**All pulse modulation specifications and supplemental characteristics apply during use of internal pulse source.**

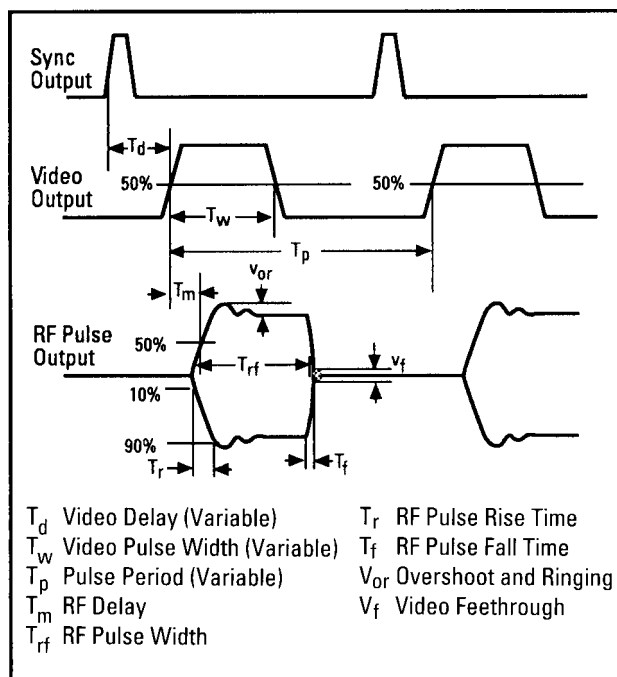

### Frequency Modulation

**Rates:** 1 kHz to 1 MHz

**Flatness:**  $\pm 2$  dB

| CARRIER FREQUENCY              |   | 256 - <500 MHz | 500 MHz - <1 GHz | 1 - 2 GHz       | 2 - 20 GHz  |
|--------------------------------|---|----------------|------------------|-----------------|-------------|
| Maximum Deviation <sup>1</sup> |   | 1.25 MHz peak  | 2.5 MHz peak     | 5 MHz peak      | 10 MHz peak |
| Modulation Index               |   | >37            | >75              | >150            | >300        |
| CARRIER FREQUENCY              | 10 - 16 MHz                               | 16 - 64 MHz    | 64 MHz - 256 MHz | 256 MHz - 1 GHz | 1 - 20 GHz  |
| FM Sensitivity                 | 40 kHz/V                                  | 80 kHz/V       | 320 kHz/V        | 1.25 kHz/V      | 5 MHz/V     |
| FM Sensitivity Accuracy        | $\pm 25\%$ at 100 kHz.                    |                |                  |                 |             |
| Incidental AM                  | <5%                                       |                |                  |                 |             |
| FM Input Impedance             | 600 $\Omega$ nominal                      |                |                  |                 |             |
| Harmonic Distortion            | <1% (1 MHz peak deviation @ 100 kHz rate) |                |                  |                 |             |

<sup>1</sup> Maximum deviation decreases by a factor of 2 for each octave below 256 MHz

### Logarithmic Amplitude Modulation (Scan Modulation)

**Maximum Depth:** > 60 dB

**Sensitivity:** -10 dB/V; (0 to +6V for 0 to -60 dBc)

Step Response (50 dB change in level):

|           |             |            |
|-----------|-------------|------------|
|           | <1 GHz      | 1 - 20 GHz |
| rise time | <10 $\mu$ s | <5 $\mu$ s |
| fall time | <20 $\mu$ s | <5 $\mu$ s |

Input Impedance: 5000 $\Omega$  nominal

Maximum Leveled Output Power in Log AM Mode (relative to CW):

|        |           |         |
|--------|-----------|---------|
| <1 GHz | 1 - 4 GHz | >4 GHz  |
| +0 dB  | -4.5 dB   | -1.0 dB |

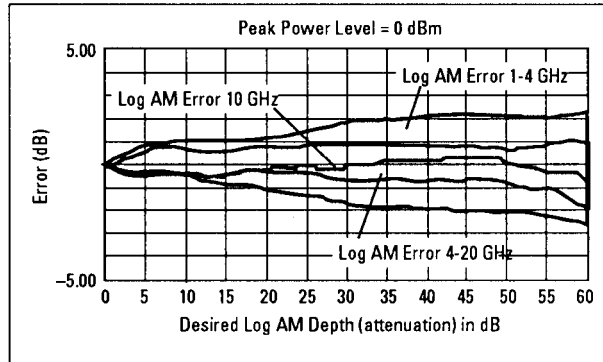

**Typical log AM error (deviation from desired depth) at 25°C for carrier frequencies between 1.0 and 20 GHz**

### Simultaneous Modulations

Full AM bandwidth and depth is available at any pulse rate or width. FM is completely independent of AM and pulse modulation.

### General

#### Programming

The HP 70340A and HP 70341A are fully compatible with the Standard Commands for Programmable Instruments (SCPI). SCPI programming complies with IEEE 488.2-1987. Optional CIIL programming compatibility is available. Please consult your HP sales representative for details.

#### Environmental

**Operating Temperature Range:** 0° to 55°C

**EMC:** Meets or exceeds EN 55011/CISPR 11/1990, Class A and Mil-Std-461C Part 2 RE02, CE03, CS02, RS03.

### 4-10 Specifications and Options

## Physical Dimensions

**Net Weight:** HP 70340A, < 9 kg (20 lb).

HP 70341A, < 2.5 kg (5 lbs).

**Shipping:** HP 70340A, < 15 kg (30 lb)

HP 70341A, < 6 kg (12 lbs).

**Size:** HP 70340A, 4/8 MMS module width.

148.5 mm H × 192.8 mm W × 477.5 mm D.

HP 70341A, 1/8 MMS module width.

148 mm H × 48.2 mm W × 477.5 mm D.

**Power Consumption:** HP 70340A, < 80 Watts.

HP 70341A, <30 Watts.



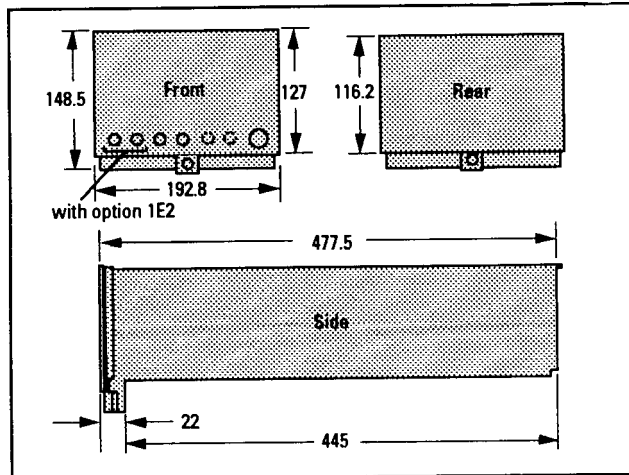

**HP 70340A Dimensions**

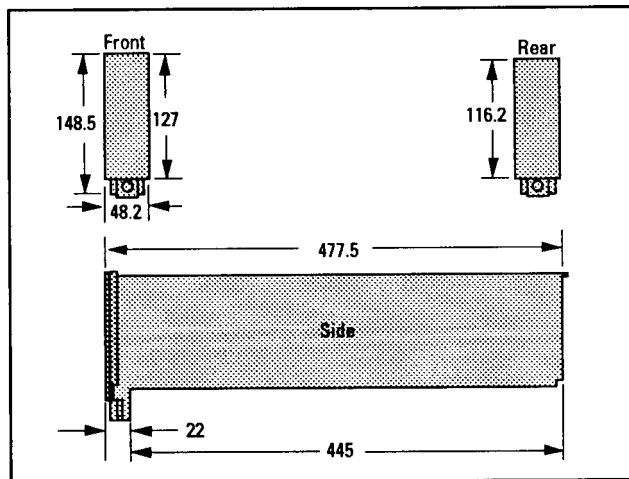

**HP 70341A Dimensions**

## Rear Panel Connectors

### HP 70340A

#### 0.5-1 GHz OUTPUT:

SMA connector outputs a 0.5 to 1.0 GHz signal for driving the HP 70341A Frequency Extension module. The HP 70341A combined with the HP 70340A extends the Signal Generator RF Output frequency range down to 0.01 GHz.

#### 0.01-1 GHz INPUT:

SMA connector accepts the HP 70341A 0.01-1 GHz output signal. The HP 70341A signal is output step attenuated in the HP 70340A with the 0.01 to 1.0 GHz output available at the front panel RF Output connector of the HP 70340A.

#### 10 MHz INPUT:

SMB connector accepts a 10 MHz  $\pm$  100 Hz, 0 to +10 dBm, external reference signal for operation from an external high stability timebase. Nominal input impedance is 50 $\Omega$ .

**10 MHz OUTPUT:**

SMB connector outputs the 10 MHz external reference signal, nominally +3 dBm, for use as an external reference signal.

**EXTERNAL ALC OUTPUT:**

SMB connector outputs external ALC drive signal (from the front panel EXT ALC input connector) to the frequency extension module.

**ALC CONTROL OUTPUT:**

SMB connector supplies a  $-10$  to  $+10$  V signal as a reference for leveling the .01 to 1.0 GHz output signal of the HP 70341A.

**0.5V/GHz OUTPUT:**

SMB connector supplies a voltage proportional to output frequency for use with mm-wave frequency multipliers, including the HP 835XX Series.

**AM OUTPUT:**

SMB connector outputs AM drive signals (from the front panel EXT PULSE input connector) to the frequency extension module.

**PULSE OUTPUT:**

2 SMB connectors output pulse modulation drive signals (from the front panel EXT PULSE input connector) to the frequency extension modules.

**HP 70341A****0.5-1 GHz INPUT:**

SMA connector accepts a 0.5 to 1.0 GHz signal from the HP 70340A that drives the HP 70341A Frequency Extension module.

**0.01-1 GHz OUTPUT:**

SMA connector outputs a 0.01-1 GHz signal which extends the HP 70340A frequency range down to 0.01 GHz. The HP 70341A signal is output step attenuated in the HP 70340A with the 0.01 to 1.0 GHz output available at the front panel RF Output connector of the HP 70340A.

**ALC CTRL:**

SMB connector accepts a  $-10$  to  $+10$  V signal as a reference for leveling the .01 to 1.0 GHz output signal.

**AM INPUT:**

SMB connector accepts AM drive signals from the HP 70340A rear panel AM OUTPUT connector.

**PULSE INPUT:**

SMB connector accepts pulse modulation drive signal from the HP 70340A rear panel PULSE OUTPUT connector).

## Options

There are several electrical, mechanical, warranty, and documentation options available for the HP 70340A and the HP 70341A.

**Electrical Options:** There are three electrical options available for the HP 70340A. These options are as follows:

### Option 1E1 - Add Output Step Attenuator

If option 1E1 is ordered, an internal step attenuator is included before the **RF OUTPUT** connector. The step attenuator has a range of 0 to 90 dB in 10 dB steps. The correct amount of attenuation is selected automatically by the Signal Generator dependent on the output power level selected. If this option is installed, you can select whether or not the step attenuator will automatically switch. This function is useful during certain applications, such as when external automatic level control is used.

### Option 1E2 - Internal Pulse Modulation Generator

If Option 1E2 is installed, the instrument includes an internal pulse source with four different pulse modes. With Option 1E2, the six pulse modulation modes available are: external, inverted external, free-run internal, gated, triggered with delay, and pulse doublet. Pulse rise and fall times are typically < 5 ns, minimum leveled pulse width is < 25 ns, and on/off ratio is > 80 dB.

### Option 1E8 - 1 Hz Frequency Resolution

Consult your HP sales representative for details on availability and retrofit information.

### Option 1E9 - 3.5 mm RF Output Connector

If option 1E9 is ordered, the **RF OUTPUT** connector is a male APC-3.5 precision connector in place of the standard female type-N connector.

## Warranty Options

### Option W30 - Two Years Additional Return to HP Service

Consult your HP sales representative for details on this option.

### Option W32 - Three Years Return to HP Calibration Service

Consult your HP sales representative for details on this option.

### Option W34 - Three Year Mil-std Calibration Service

Consult your HP sales representative for details on this option.

Longer term warranty and calibration services are available. Please consult your HP sales representative for details.

## Documentation Options

The documentation options, 0B2 and 0BV, and 0BW that follow are available when the Signal Generator is ordered and received with shipment of the instrument. If the documentation was not ordered with the original shipment and is now desired, it can be ordered from the nearest Hewlett-Packard office.

### Option 0B2 - Extra User Documentation

If option 0B2 is ordered with the HP 70340A, the shipment includes an extra set of user documentation. This includes a copy of the *HP 70340A/41A User's Guide*, the *HP 70340A/41A Quick Start Guide*, the Calibration Software, and the *HP 70340A/41A Calibration Guide*.

If Option 0B2 is ordered with the HP 70341A, the shipment contains an extra copy of the *HP 70341A Installation Guide*.

### Option 0BW - Add Assembly-level Service Documentation

If option 0BW is ordered with the HP 70340A, the shipment contains a set of assembly-level service documentation. This includes the *HP 70340A Service Guide*, the *HP 70340A/41A Calibration Guide*, and the Calibration Software. Note that the *Service Guide* is not shipped with the HP 70340A if option 0BW is not ordered.

### Option 0BV - Add Component-level Service Documentation

If option 0BV is ordered with the HP 70340A, the shipment contains a set of component level service information, the *HP 70340A Component Level Information*. Note that the *CLIM* is not shipped with the HP 70340A if option 0BV is not ordered.



## Signal Generator Menus and Functions

---

This chapter is a reference which contains the HP 70340A modular signal generator and HP 70341A frequency extension module menus and functions. Entries in this chapter are alphabetized under each main menu. The main menus are listed in the order that they appear on the display. The menus are: Frequency, Amplitude, Modulation, Modify Step, State, and Miscellaneous.

**Main Menus** listings show a graphical depiction of the menu structure so that you can see how to access all of its functions.

**Functions** listings provide detailed descriptions of a function and its limits. Where appropriate, the entries contain examples, detailed technical or application information, and/or a “See Also” section.

Several signal generator functions are common to more than one menu. These functions follow:

- The **ENTER** softkey terminates data entry of unitless parameters like: multiplier values, instrument state registers, flatness correction registers, and HP-IB addresses.
- Units terminator softkeys include: **GHz**, **MHz**, **kHz**, **Hz**, and **dBm**. These softkeys appear when data is entered using the numeric keypad so that the data can be terminated and entered with the appropriate units.
- The **MORE 1 of 2**, **MORE 1 of 3**, **MORE 2 of 3**, **MORE 2 of 2**, or **MORE 3 of 3** softkeys appear when there is more than one “page” to a menu. Selecting these functions accesses additional functions under a menu.
- The **prev menu** and **CANCEL** softkeys return the previous menu without performing the function that was selected. Similarly, the **ABORT** softkey stops running the current function, maintains (does not update) the old data, and returns the previous menu.

## Freq

The Frequency menu accesses the CW FREQUENCY and FREQUENCY MULTIPLIER functions as shown:

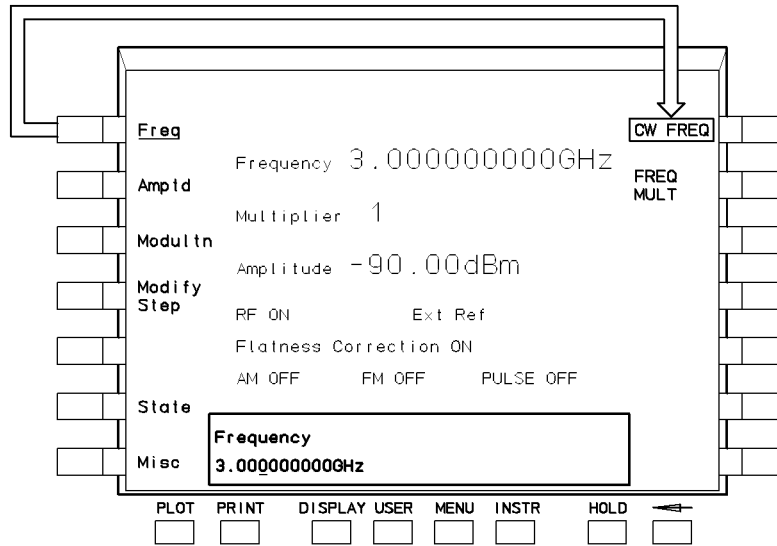

Figure 5-1. Frequency Menu Structure

---

## CW FREQ

Selecting the **Freq** menu and then the **CW FREQ** (CW FREQUENCY) softkey allows input of the signal generator output frequency using the Knob, **↑** **↓** (arrow step) keys, or numeric keypad keys and units terminator softkeys.

---

When CW FREQUENCY is active, it appears in inverse video.

The **INSTR PRESET** (**I-P**) value of CW FREQUENCY is 3 GHz, the Knob increment value is 1 MHz, and the **↑** **↓** keys increment value is 100 MHz.

### Data Entry

The allowable range for data entry of CW frequencies is from 1 GHz to 20.00000000 GHz. If you enter a frequency below 1 GHz, the signal generator accepts and outputs 1 GHz. Similarly, if you enter a frequency above 20 GHz, the signal generator accepts and outputs 20 GHz.

Standard frequency resolution is 1 kHz. If you enter a frequency with less than 1 kHz resolution, the signal generator rounds the value to the nearest kHz. The increment value also rounds to the nearest kHz.

When the numeric keypad is used to enter a frequency, the appropriate units terminator softkeys: (**Hz**, **kHz**, **MHz**, **GHz**, and **CLEAR**) appear. The CLEAR function is used to abort the current entry and return the previous (Frequency) menu.

---

### Notes

1. If the FREQUENCY MULTIPLIER function is used in conjunction with CW FREQUENCY, the frequency displayed is the multiplier output frequency, not the signal generator output frequency.
2. When Option 1E8 is installed in the instrument, frequency resolution is 1 Hz over the 1 to 20 GHz frequency range.

---

### Equivalent SCPI Command

**FREQ freq**

*sets CW frequency to the value indicated by the "freq" parameter*

### See Also

**Freq**

**FREQ MULT**

[SOURce[1]:]FREQuency[:CW:FIXed] Command  
"To Generate a CW Signal"



---

## FREQ MULT

Selecting the **Freq** menu and then the **FREQ MULT** (FREQUENCY MULTIPLIER) softkey allows entry of a FREQUENCY MULTIPLIER value using the Knob, the  $\uparrow$  and  $\downarrow$  keys, or the numeric keypad. Once the FREQUENCY MULTIPLIER value is entered, the display indicates the frequency at the output of an external frequency multiplier.

---

FREQUENCY MULTIPLIER appears in inverse video when it is active.

When you press **FREQ MULT**, the multiplier value is displayed in the data entry box in the following format:

```
FREQUENCY MULTIPLIER  
XXX
```

*where XXX is the multiplier value.*

The allowable range for multiplier values is 1 to 100. The **INSTR PRESET** (**(L-P)**) value is 1 and the preset Knob/arrow increment value is 1.

### Applications

The FREQUENCY MULTIPLIER function is useful when generating millimeter-wave signals with external multiplier equipment. The FREQUENCY MULTIPLIER scales the displayed RF Output frequency. The display shows the frequency at the output of the external frequency multiplier, not the frequency at the signal generator **RF OUTPUT** connector.

For example, assume that you want to generate 30 GHz with an external frequency doubler. The signal generator cannot generate a 30 GHz signal, directly, but you have a frequency doubler which is used at the **RF OUTPUT** connector to multiply a 15 GHz signal by two. Setting the FREQUENCY MULTIPLIER value to two allows you to display the output of the multiplier on the signal generator. In this case, the signal generator displays 30 GHz while actually outputting 15 GHz. Similarly, entering a new frequency of 32 GHz causes the signal generator to output 16 GHz.

### Data Entry

The two ways to enter a FREQUENCY MULTIPLIER value are with: the numeric keypad or the  $\uparrow$   $\downarrow$  (arrow step) keys.

When you use the numeric keypad to enter a FREQUENCY MULTIPLIER value, the **ENTER** and **CLEAR** softkeys appear on the display. Selecting **ENTER** terminates the entry while selecting **CLEAR** returns the previous data.

The minimum resolution at the output of the FREQUENCY MULTIPLIER is:

`signal generator min resolution × the multiplier value`

For instance, assume that you have entered a multiplier value of 2 and that you attempt to enter a frequency of 30.00001000 GHz with the CW FREQUENCY function and numeric keypad. The actual frequency that the signal generator must generate is 15.00000500 GHz which requires a resolution of 500 Hz. Option 1E8 (resolution of 1 Hz) must be installed in order to display 30.00002000 GHz and output 15.00000500 GHz. If Option 1E8 is *not*

installed in the instrument, the actual output frequency is 15.000001000 GHz, and the display shows 30.000002000 GHz since specified resolution is 1000 Hz.

### **Equivalent SCPI Command**

`FREQ:MULT multiplier`  
*sets the frequency multiplier value*

### **See Also**

[Freq](#)  
[SOURce[1]:]FREQuency:MULTiplier Command  
To Generate Millimeter Signals.

## Amptd

Selecting the Amplitude menu accesses the functions that relate to RF output power (amplitude) and signal leveling.

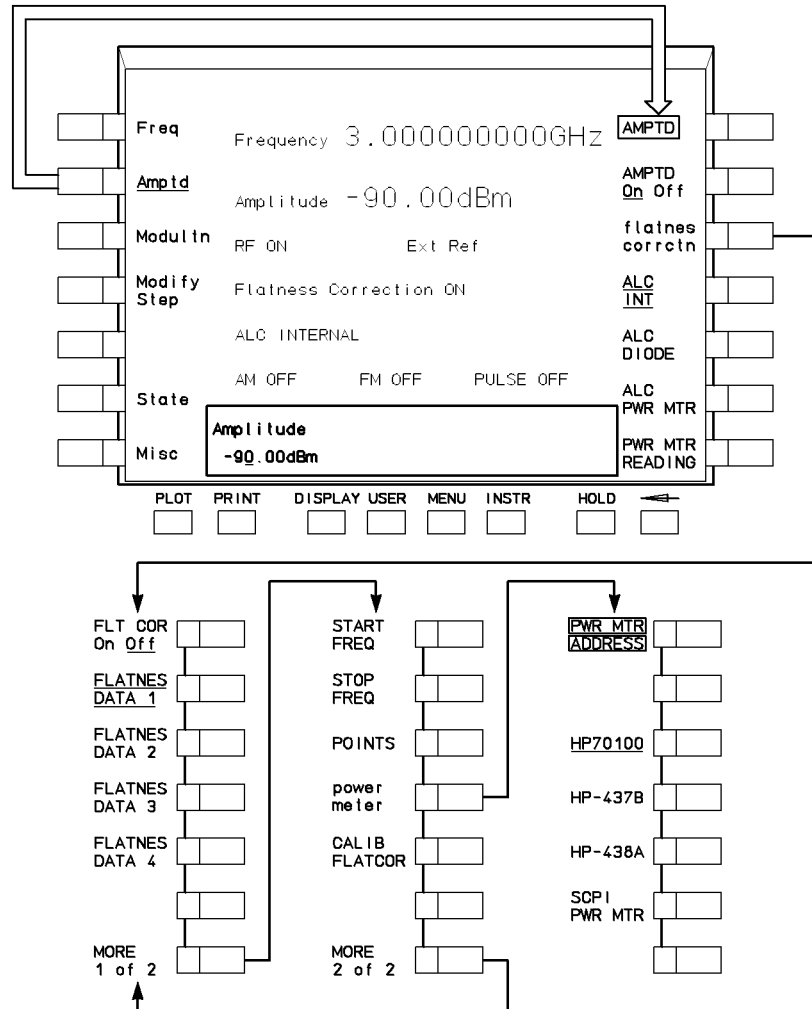

Figure 5-2. Amplitude Menu Structure

---

## ALC DIODE

Selecting the **Amptd** menu and then the **ALC DIODE** softkey enables automatic leveling control using an external diode detector.

---

Under **(INSTR PRESET)** **(I-P)** conditions, the ALC DIODE function is *disabled*, and the ALC INTERNAL function is *enabled*.

When the ALC DIODE function is active, it is indicated by underscoring the softkey. The display indicates that the function is active by the message “ALC Diode.”

### External Diode Detector Leveling

The purpose of a leveling circuit is to provide constant power, independent of the load, and minimize power variations versus frequency.

External diode detector leveling is used in applications where it is desired to continuously level the power at some point outside the signal generator with an external diode detector. When frequency dependent losses are involved, the RF output power at the end of the signal path will not have a constant amplitude over the signal generator frequency range. For example, if a cable is used at the output of the signal generator that has a constant 0.5 dB/GHz loss, 5 dB of attenuation at the output of the cable occurs after a 10 GHz frequency increase, even though the power at the input to the cable is constant. By externally leveling power at the output of the cable, the signal generator would increase power at the input of the cable to produce a constant power level at the output of the cable.

External diode detector leveling requires that external equipment be connected to the signal generator, as shown in Figure 5-3.

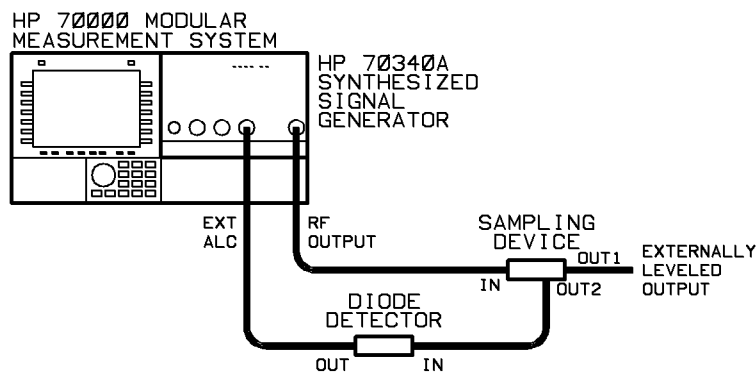

**Figure 5-3. External Diode Leveling Set-up**

When external diode detector leveling is chosen, power is sampled at the external sampling device (either a directional coupler or power splitter) by an external diode detector that is typically operating in the square law region. When the diode detector is operating in the square law region, it will provide a DC voltage that is proportional to the power sampled at the input to the detector. This DC voltage is fed back to the signal generator via the **EXT ALC** connector. The signal generator then adjusts its output power level to maintain a constant power level at the input to the external diode detector.

## Applications

External leveling can be used when your application requires long cables that will cause frequency-dependent losses. It also enables devices, such as amplifiers, mixers, etc. to be inserted into the RF signal path so that the output of the inserted device is controlled by the signal generator.

## Advantages of Diode Detector Leveling

When diode detector leveling is used, power level correction is continuous.

External diode detector leveling has the advantage of faster settling time than power meter leveling. The settling time is variable and is dependent on the devices in the external leveling loop.

## Disadvantages of Diode Detector Leveling

The diode detector must be capable of producing between 1 mV and 1V of ALC voltage for the power level at the sampling point. This typically restricts the lower limit at which external diode detector leveling will function.

Diode detector leveling does not provide an accurate power display on the signal generator. Diode detector leveling also does not provide temperature compensation. Power level recalibration may be required in environments that are not temperature stabilized.

External diode detector leveling requires that external equipment be connected to the signal generator.

---

|             |  |
|-------------|--|
| <b>Note</b> | Before selecting the ALC DIODE function, you should adjust the signal generator power level using internal leveling so that the step attenuator is set to the correct setting. |
|-------------|--|

---

## Equivalent SCPI Command

```
POW:ALC:SOUR DIOD
```

```
POW:ALC:SOUR MMH
```

*either one of these commands sets the ALC source to diode*

## See Also

```
FLATCOR On Off
```

```
ALC PWR MTR
```

```
ALC INT
```

```
ATTEN Auto Hld
```

```
AMPTD
```

[SOURce[1]:]POWer:ALC:SOURce Command  
“To Use External Diode Detector Leveling”

---

## ALC INT

Selecting the **Amptd** menu and then the **ALC INT** (ALC INTERNAL) softkey provides a leveled output signal at the **RF OUTPUT** connector that is held constant over the entire frequency range of the instrument.

---

When the ALC INTERNAL function is active, it is indicated by an underscore; the display reads “ALC INTERNAL.”

Under **INSTR PRESET** (**I-P**) conditions, ALC INTERNAL is enabled.

Internal ALC is used to control the internal RF signal over a specified range (the vernier range) of  $-4$  to  $+10$  dBm. Additional dynamic range is provided by an optional 90 dB step attenuator (Option 1E1) to give an effective dynamic range of  $-90$  to  $+8$  dBm.

An ALC Unleveled condition occurs when the internal ALC circuitry cannot maintain leveling. This may happen because of an instrument fault or because the instrument is set to level for an RF output level that is beyond its capability. Calibrated output level is only guaranteed when the UNLEVELED Led is not lit.

When the signal generator UNLEVELED Led lights, the Knob arrow keys or the numeric keypad can still be used to change displayed power up to the maximum value. However, the actual output power will *not* increase. Only the displayed value changes.

The internal ALC circuit maintains a constant RF power level over frequency at the **RF OUTPUT** connector. The ALC circuit is a feedback control system where output power is measured and compared to the desired power level. When output power does not equal the desired power level, the ALC changes the output until the actual and desired levels are equal.

The allowable range for power level entries (using the AMPLITUDE function under the Amplitude menu) is  $-15$  dBm to  $+30$  dBm for standard configuration instruments and  $-100$  dBm to  $+30$  dBm if option 1E1 is installed.

The actual maximum leveled power available is dependent upon the frequency and varies across the range of the signal generator.

---

**Note** The actual maximum internally leveled output power for your instrument at a given frequency can be found by increasing the signal generator output power until the UNLEVELED Led lights.

---

### Advantages of Internal Leveling

Internal leveling is self-contained; it does not require any external equipment as does external diode leveling or external power meter leveling. Leveled power is specified at the **RF OUTPUT** connector.

## Disadvantages of Internal Leveling

Internal leveling does not compensate for losses or gains in the output signal path.

## Equivalent SCPI Commands

`POW:ALC:SOUR INT` *enables internal leveling.*

## See Also

To Use the Flatness Correction Routine

To Use External Diode Detector Leveling

To Use External Power Meter Leveling

`FLATCOR On Off`

`ALC DIODE`

`ALC PWR MTR`

`AMPTD`

`UNLEVELED` Led

`[SOURce[1]:]POWER:ALC:SOURce` Command

## ALC PWR MTR

Selecting the **Amptd** menu and then the **ALC PWR MTR** (ALC POWER METER) function enables automatic leveling at a point other than the signal generator RF Output. ALC POWER METER requires an external power meter and sensor as a detector system.

When the ALC POWER METER function is active, it is indicated by an underscore, and the display reads “ALC PWR MTR.”

In order to properly externally level a signal, this function must be used in conjunction with the POWER METER READING function. The POWER METER READING is the power level that is used by the signal generator to calibrate the recorder output voltage of the power meter versus the signal generator output power. Refer to the procedure, “To Use External Diode Detector Leveling,” in the chapter, “Generating Signals,” and the POWER METER READING entry in this chapter for detailed information.

### External Power Meter Leveling

The purpose of a leveling circuit is to provide constant power, independent of the load, and minimize power variations versus frequency.

External power meter leveling is used in applications where the requirement is leveled power at some point outside the signal generator with an external power meter. When frequency dependent losses are involved, the RF output power at the end of the signal path will not have a constant amplitude over the signal generator frequency range. For example, if a cable is used at the output of the signal generator that has a constant 0.5 dB/GHz loss, 5 dB of attenuation at the output of the cable occurs after a 10 GHz frequency increase, even though the power at the input to the cable is constant. By externally leveling power at the output of the cable, the signal generator increases power at the input of the cable to produce a constant power level at the output of the cable.

External power meter leveling requires that external equipment be connected to the signal generator, as shown in Figure 5-4.

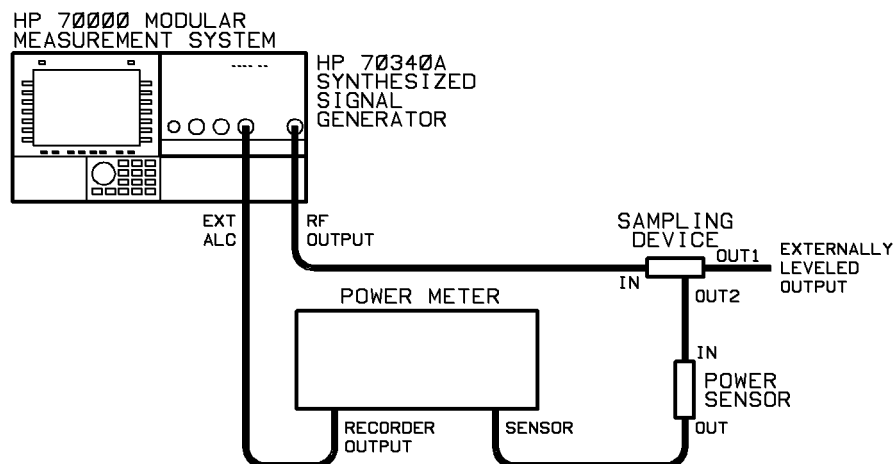

Figure 5-4. External Power Meter Leveling Set-up



When the ALC POWER METER function is on, power is sampled at the external sampling device (either a directional coupler or power splitter) by the external power sensor. An automatic level control voltage is then generated by the external power meter and fed back to the signal generator via the **EXT ALC** connector. The signal generator then adjusts its output power level to maintain a constant power level at the input of the external power sensor.

## Applications

External leveling can be used when applications require long cables that will cause frequency-dependent losses. External leveling also enables devices, such as amplifiers, mixers, etc. to be inserted into the RF signal path so that the output of the inserted device is controlled by the signal generator.

## External Equipment Limitations

The power meter must be capable of producing a 0V to 1V output voltage linearly proportional to power over each decade of range. The recorder output of most power meters provides this voltage.

The power sensor must have a frequency range that is appropriate for the range of frequencies being leveled. The sensor must also have enough dynamic range to measure the level at the output of the directional coupler or power splitter. As an example, to level signals in the  $-7$  dBm to 0 dBm range using a 10 dB coupler, the power sensor must be capable of measuring power in the  $-17$  to  $-10$  dBm range.

## Advantages of Power Meter Leveling

When the ALC POWER METER function is used for power meter leveling, power level correction is continuous.

External power meter leveling has the advantages of better accuracy and temperature stability, and improved vernier linearity than external diode detector leveling. Using a sensitive power sensor allows ALC at levels as low as the power meter and sensor can measure.

## Disadvantages of Power Meter Leveling

One disadvantage of power meter leveling is a longer settling time than diode detector or internal leveling. The settling time is dependent on the power range and sensor used. The signal generator assumes a settling time of two seconds in order to allow the sensor to reach the correct power level. Depending upon the power sensor and range being used, the power meter might or might not finish settling within this time. For two of the power sensor high ranges, the power meter typically settles within two seconds.

Another disadvantage of external power meter leveling is that it can not be used when the output is being pulse modulated.

External power meter leveling requires that external equipment be connected to the signal generator.

---

|             |   |
|-------------|---|
| <b>Note</b> | Before selecting ALC POWER METER, you should adjust the power level using internal leveling (ALC INTERNAL) so that the step attenuator is set to the correct setting. |
|-------------|---|

---

If the procedure, “To Use External Power Meter Leveling,” is followed correctly, the RF Output is externally leveled via the power meter feedback loop once the Range Hold Meter Value is entered into the signal generator.

### **Equivalent SCPI Commands**

`POW:ALC:SOUR PMET`

*sets the ALC source to power meter*

`POW:ALC:PMET pmeter`

*sets the power meter range hold value as defined by the “pmeter” function*

## See Also

AMPTD

power meter

ALC DIODE

ALC INT

FLATCOR On Off

PWR MTR READING

[SOURce[1]:]POWer:ALC:SOURce Command

[SOURce[1]:]POWer:ALC:PMETer[:LEVEL][:AMPLitude] Command



“To Use External Power Meter Leveling”

---

## AMPTD

Selecting the **Amptd** menu and then the **AMPTD** (AMPLITUDE) softkey allows you to set the amplitude at the signal generator **RF OUTPUT** connector or at some point in the signal path that is external to the signal generator.

---

The preset state of the increment values for the Knob and   keys is 1.00 dBm.

When active, the AMPLITUDE function displays in inverse video, indicating that you can enter an output power level using the Knob, arrow keys, or numeric keypad and **dBm** softkey. Once you enter an RF output amplitude, the value is updated on the display:

```
Amplitude
XXXXdBm
where XXXX is the power level value in dBm
```

The **INSTR PRESET** (**(-P)**) value of AMPLITUDE is -90.00 dBm if Option 1E1 is installed, and 0 dBm otherwise.

When Option 1E1 is installed, you can enter power levels between -100 and +30 dBm using the AMPLITUDE function. Otherwise, the allowable range is -15 to +30 dBm.

---

**Note** You can determine your signal generator actual maximum power internal leveling capability at a given frequency by increasing the output power with the AMPLITUDE function until the UNLEVELED Led lights.

---

When you change the power level using AMPLITUDE, the signal generator circuitry ensures that, during the transition from the old level to the new level, the **RF OUTPUT** level does not exceed by more than 1 dB the higher of the two power levels.

The signal generator provides three choices for output amplitude leveling: internal (ALC INTERNAL), external (ALC DIODE) diode, and external power meter (ALC POWER METER).

## Data Entry

The instrument resolution for output power is 0.01 dB. Thus, the minimum allowable increment value that can be entered is 0.01 dBm.

When using the numeric keypad to enter a negative value, you can press the  key any time before you press the **dBm** softkey.

## Equivalent SCPI Command

```
POW level
sets the power level of the generator as defined by the "level" parameter
```

## See Also

Amptd

AMPTD On Off

ALC INT

ALC DIODE

ALC PWR MTR

FLATCOR On Off

[SOURce[1]:]POWer[:LEVel] Command

[SOURce[1]:]UNIT:POWer Command

---

## AMPTD On Off

Selecting the **Amptd** menu and then the **AMPTD On Off** (AMPLITUDE On Off) softkey turns power at the **RF OUTPUT** connector **On** and **Off**.

---

The state of AMPLITUDE On/Off is indicated by underscoring **On** or **Off** in the softkey. When AMPLITUDE On/Off is **On** or **Off**, the display shows either the message “RF ON” or “RF OFF.”

The **INSTR PRESET** (**I-P**) value for this function is **On**.

Turning the AMPLITUDE On/Off function **Off** turns off the RF power at the **RF OUTPUT** connector but does not switch the output attenuator. The internal oscillators are turned off, and the internal RF power shutdown circuit is turned on.

When AMPLITUDE On/Off is **Off**, any **UNLEVELED** messages are blocked.

### Equivalent SCPI Command

`OUTP:STAT ON|OFF`

*turns the signal at the RF OUTPUT connector on or off*

### See Also

**AMPTD**

**ATTEN AutoHld**

OUTPut[:STATe] Command

Connectors-Front Panel

---

## CALIB FLATCOR

Selecting the **CALIB FLATCOR** (CALIBRATE FLATNESS CORRECTION) function (under the **Amptd** and then **flatnes corrctn** menus) runs the CALIBRATE FLATNESS CORRECTION routine which creates a table in the signal generator memory of external path loss versus frequency.

Data required to perform this calibration includes: start frequency, stop frequency, and number of data points. In addition, HP-IB communication with an external power meter is required.

---

This function appears in inverse video while the routine is running.

When **CALIB FLATCOR** is selected, initially, the display returns the **CALIB FLATCOR** and **prev menu** softkeys. Selecting **CALIB FLATCOR**, again, initiates data collection, while selecting the **prev menu** softkey returns the flatness correction menu without running the calibration.

For each frequency point in the routine, the signal generator sends the power meter the frequency, waits for the meter to settle, and then reads the power value from the power meter. As the calibration runs, the signal generator displays each frequency and measured power (not the loss) in the data entry box. The signal generator calculates the loss data by subtracting the power meter reading from the current power level. (The signal generator power level is constant during the CALIBRATE FLATNESS CORRECTION routine.)

Once the CALIBRATE FLATNESS CORRECTION routine has finished running and the new flatness correction table has been generated, the data is *automatically* stored in the currently selected FLATNESS DATA register. The functions which select the data registers are: FLATNESS DATA 1, FLATNESS DATA 2, FLATNESS DATA 3, and FLATNESS DATA 4.

The CALIBRATE FLATNESS CORRECTION routine can be run at any power level. However, for best accuracy, the signal generator should be leveled. It should also be ensured that the power sensor operates correctly over the range of frequencies and power levels expected at the external port. If possible, choose the signal generator power levels such that the sensor is operating in its optimum range (not the top 10 dB or the bottom 10 dB of the range).

The CALIBRATE FLATNESS CORRECTION routine corrects not only for loss, but also for gain in the external path. Note that, for the calibration to work correctly, the path loss or gain must be linear. The maximum amount of correction is  $\pm 40$  dB. The signal generator adjusts the attenuator setting, if necessary.

---

**Note**            The signal generator clears any old flatness correction data from the register selected and replaces it with the new data.

---

The flatness correction data remains resident in the signal generator memory even when power is turned off or **INSTR PRESET** (**I-P**) is pressed.

---

**Note**

If the CALIBRATE FLATNESS CORRECTION routine is aborted (by selecting the ABORT function), the existing flatness correction data remains unaffected.

---

**Equivalent SCPI Command**

There is no equivalent SCPI command for the CALIBRATE FLATNESS CORRECTION function. However, the “MEM:TABLE:FREQ” and “MEM:TABLE:LOSS” command can be used to directly enter frequency and correction factor data points into a level correction table.

**See Also**

To Use the Flatness Correction Routine

`flatnes correctn`

`FLATCOR On Off`

`START FREQ`

`STOP FREQ`

`POINTS`

`FLATNES DATA x`

`power meter`

`HP xxx`

`SCPI PWR MTR`

`PWR MTR ADDRESS`

`MEMory:TABLE:FREQuency`

`MEMory:TABLE:LOSS[:MAGNitude]`



---

## FLATCOR On Off

Pressing the **Amptd** menu, the **flatnes corrctn** submenu, and then the **FLATCOR On Off** (FLATNESS CORRECTION On/Off) softkey turns flatness correction **On** or **Off** in order to compensate for losses in the signal path.

---

When FLATNESS CORRECTION is on, **On** is underscored in the function softkey. Similarly, **Off** is underscored when the function is off.

The **INSTR PRESET** (**I-P**) state for this function is off.

The FLATNESS CORRECTION routine compensates for external path loss measured during the CALIBRATE FLATNESS CORRECTION routine at the external port. When FLATNESS CORRECTION is on, the external path loss data in the current FLATNESS CORRECTION DATA register is added to the power level of the signal generator. The registers are FLATNESS DATA 1, FLATNESS DATA 2, FLATNESS DATA 3, and FLATNESS DATA 4. The current register is the one that is underscored. Thus, power is flat and leveled over the range of frequency points where data was measured during the routine. For example, assume that the flatness correction factor at 10 GHz is 4 dB (because there is 4 dB of path loss between the **RF OUTPUT** connector and the test point). Then, if  $-10$  dBm is desired at 10 GHz (and the FLATNESS CORRECTION function is on), the signal generator actually generates  $-6$  dBm so that the power level at the test point is  $-10$  dBm. Notice that path loss correction is independent of power level.

The FLATNESS CORRECTION function is independent of the data stored in the instrument STATE registers.

---

### Notes

1. If more power is required at the RF OUTPUT than the signal generator can deliver, an error message is generated. This can occur when the external signal path has loss and the power level is set close to maximum leveled power.
2. If the FLATNESS CORRECTION function is on, and an output frequency is requested from the signal generator that is either greater than the stop frequency or less than the start frequency, the flatness correction factor at either the STOP FREQUENCY or the START FREQUENCY is used.

---

### Equivalent SCPI Command

`CORR:CSET:STAT On/Off`

*turns the use of flatness correction data on or off*

## See Also

To Use the Flatness Correction Routine

START FREQ

STOP FREQ

POINTS

FLATNES DATA x

flatnes corrctn

Amptd

PWR MTR ADDR

HP xxx

SCPI PWR MTR

power meter CORRection:CSET:STATe On/Off

---

## `flatnes corrctn`

Selecting the `flatnes corrctn` menu accesses the functions which set up and initiate the CALIBRATE FLATNESS CORRECTION routine and turn on FLATNESS CORRECTION.

---

The CALIBRATE FLATNESS CORRECTION routine uses a power meter which is controlled through HP-IB by the signal generator. The power meter measures the external path loss. The correction is not continuous as in external power meter leveling. Rather, the signal generator provides constant leveled power versus frequency at a particular external port. Refer to CALIBRATE FLATNESS CORRECTION and FLATNESS CORRECTION On/Off entries in this chapter. Also, refer to “To Use the Flatness Correction Routine” and “To Use Previously Stored Flatness Correction Data” in Chapter 3.

---

## FLATNESS DATA x

Selecting the `Amptd` menu, the `flatnes corrctn` submenu, and then either `FLATNES DATA 1`, `FLATNES DATA 2`, `FLATNES DATA 3`, or `FLATNES DATA 4` selects the register from which flatness data is recalled or to which data is stored.

---

Only one of the four FLATNESS DATA registers can be selected at a time. The selected register is indicated by an underscore.

When the FLATNESS CORRECTION function is on, the data in the current (underscored) FLATNESS DATA register is used to change the power level of the signal generator. If no flatness correction data is stored in the selected FLATNESS DATA register, the Signal Generator generates an error message and the current data does not change.

When the CALIBRATE FLATNESS CORRECTION routine is run, the table of path loss versus frequency values is stored in the current (underscored) FLATNESS DATA register. Consequently, when the CALIBRATE FLATNESS CORRECTION routine is complete, any old data in the current register is replaced by the new data.

The FLATNESS DATA registers operate independently of the instrument STATE registers.

### Equivalent SCPI Command

`CORR:CSET FDAT register`

*Selects the flatness correction data register to be used where “register” is an integer between 1 and 4.*

### See Also

To Use the Flatness Correction Routine

To Use Previously Stored Flatness Correction Data

`FLATCOR On Off`

`START FREQ`

`STOP FREQ`

`POINTS`

`flatnes corrctn`

`Amptd`

`PWR MTR ADDR`

`HP xxx`

`SCPI PWR MTR`

`power meter`

---

## HP xxx

Selecting the softkey sequence: `Amptd`, `flatnes corrctn`, `MORE 1 of 2`, `power meter`, and then `HP-437B`, `HP-438A`, or `HP70100` (HP 437B, HP 438A, or HP 70100A) allows bus communication to an external HP power meter during the CALIBRATE FLATNESS CORRECTION routine.

---

Any one of these functions is on when indicated by an underscore. The default setting of these functions is off, and only one of the three may be on at any given time.

The HP xxx Power Meter functions coupled with the POWER METER ADDRESS function determine the external power meter that is used in flatness correction applications.

During the CALIBRATE FLATNESS CORRECTION routine, the signal generator sends the power meter each frequency point. The HP 437B, HP 438A, or HP 70100A uses the frequency data to retrieve the cal factor for the power sensor. To achieve the highest accuracy, the correct cal factor data for the sensor must be loaded into the power meter.

A SCPI compatible power meter can also be used for flatness correction when the SCPI POWER METER function is selected.

### See Also

`power meter`

`PWR MTR ADDRESS`

`SCPI PWR MTR`

`CALIB FLATCOR`

`flatnes corrctn`

---

## POINTS

Selecting the **POINTS** function (under the **Amptd** main menu and **flatnes corrctn** submenu) allows entry of the number of frequency points to be stored during the CALIBRATE FLATNESS CORRECTION routine.

---

When this function is selected, the display data entry box indicates “Set number of points **XX**” where “**XX**” is the current number of points. The number of points can be changed using the Numeric Keypad and ENTER function, the Knob, or the Arrow Keys.

The allowable range for POINTS is from 2 to 401. The number of points includes the START FREQUENCY and the STOP FREQUENCY. The preset increment value is 1.

The signal generator uses the value of POINTS along with START FREQUENCY and STOP FREQUENCY determine the spaced frequency spacing in the flatness correction table. Frequency spacing is even; however, if the calculated frequency is not within the signal generator resolution, it is rounded.

### **Equivalent SCPI Command**

There is no equivalent SCPI command for the points function. However, the MEM:TABL:FREQ and MEM:TABL:LOSS command can be used to directly enter frequency and correction factor data into a flatness correction table.

## See Also

To Use the Flatness Correction Routine

FLATCOR On Off

CALIB FLATCOR

power meter

PWR MTR ADDRESS

HP xxx

SCPI PWR MTR

START FREQ

STOP FREQ

MEMory:TABLE:FREQuency

MEMory:TABLE:LOSS[:MAGNitude]

---

## power meter

Selecting `Amptd`, `flatnes corrctn`, and then `power meter`, accesses functions which assign the external power meter being used in the flatness correction routine.

---

The power meter functions are POWER METER ADDRESS, SCPI POWER MTR, HP-437B, HP-438A, and HP70100.

### See Also

`PWR MTR ADDRESS`

`HP xxx`

`SCPI PWR MTR`



---

## PWR MTR ADDRESS

Selecting the PWR MTR ADDRESS (POWER METER ADDRESS) function (selecting `Amptd`, `flatnes corrctn`, `power meter`, `PWR MTR ADDRESS`) tells the signal generator which HP-IB address the power meter is using during the CALIBRATE FLATNESS CORRECTION routine. Note that this function does *not* set the address of the power meter.

---

The default power meter address is 13.

This function is also used to enter the power meter address during other applications which require an external power meter.

Presetting the instrument does not affect this function.

### Equivalent SCPI Command

`SYST:COMM:PMET:ADDR Address`

*tells the signal generator what power meter address should be used during user flatness correction*

### See Also

To Use the Flatness Correction Routine

`SYSTEM:COMMunicate:PMETER:ADDRESS Command`

`flatnes corrctn`

`power meter`

`HP xxx`

`SCPI PWR MTR`

---



## PWR MTR READING

Selecting the **Amptd** menu and then the **PWR MTR READING** (POWER METER READING) function accesses the external power meter (range-hold) reading so that it can be modified for existing power meter leveling conditions.

---

Valid entries for this function are between  $-90$  dBm and  $+25$  dBm. The preset value for this function is 0 dBm.

The POWER METER READING is the range hold power level that is entered during the external power meter leveling procedure. The signal generator uses this power reading to calibrate the recorder output voltage versus the signal generator output power. Refer to the procedure, “To Use External Power Meter Leveling,” in Chapter 3, “Generating Signals.”

The Modify Step menu can be used in conjunction with POWER METER READING in order to change the step size of the   keys or the increment value of the Knob. The preset values for the knob and arrow keys are both 1 dB.

### See Also

**ALC PWR MTR**

---

## SCPI PWR MTR

Selecting the softkey sequence: `Amptd`, `flatnes corrctn`, `MORE 1 of 2`, `power meter`, and `SCPI PWR MTR` (SCPI POWER METER), allows bus communication to a SCPI compatible external power meter during the CALIBRATE FLATNESS CORRECTION routine.

---

This function is on when indicated by an underscore. The default setting of this function is off.

The SCPI POWER METER and POWER METER ADDRESS functions determine the external power meter that is used in flatness correction applications.

During the CALIBRATE FLATNESS CORRECTION routine, the signal generator sends the power meter each frequency point. The SCPI POWER METER uses the frequency data to retrieve the cal factor for the power sensor. To endure the best possible accuracy, the correct cal factor data for the sensor must be loaded into the power meter.

An HP 437B, HP 438A, or HP 70100A power meter can also be used for flatness correction when the `HP-437B`, `HP-438A`, or `HP70100` softkey is selected.

### See Also

To Use the Flatness Correction Routine

`power meter`

`PWR MTR ADDRESS`

`HP xxx`

`flatnes corrctn`

---

## START FREQ

Selecting the **START FREQ** (START FREQUENCY) function under the **Amptd** and **flatnes corrctn** menus allows entry of the beginning frequency for the flatness correction table.

---

The preset value for the START FREQUENCY increment value is 100 MHz.

When START FREQUENCY is selected, the display data entry box reads: "COR START = XXXGHz" where XXX is the current start frequency. A new frequency can be entered using the numeric keypad and the ENTER function or modified using the Knob or Arrow Keys.

The START FREQUENCY lower limit is equal to the signal generator lower frequency limit. The START FREQUENCY upper limit is equal to the STOP FREQUENCY minus the minimum frequency resolution at that frequency.

### **Equivalent SCPI Command**

There are no equivalent SCPI commands for the flatness correction functions. However, the MEM:TABL:FREQ and MEM:TABL:LOSS commands can be used to directly enter frequency/correction factor data points into a flatness correction table.

## See Also

To Use the Flatness Correction Routine

STOP FREQ

POINTS

CALIB FLATCOR

FLATCOR On Off

MEMory:TABLE:FREQuency

MEMory:TABLE:LOSS[:MAGNitude]

---

## STOP FREQ

Selecting the **STOP FREQ** (STOP FREQUENCY) function under the **Amptd** and **flatnes corrctn** menus allows entry of the ending frequency for the flatness correction table.

---

The preset value for STOP FREQUENCY increment is 100 MHz.

When STOP FREQUENCY is selected, the display data entry box reads: “COR STOP = XXXGHz” where “XXX” is the current stop frequency. A new frequency can be entered using the numeric keypad and the ENTER function or modified using the Knob or Arrow Keys.

The STOP FREQUENCY lower limit is equal to the START FREQUENCY plus the minimum frequency resolution at that frequency. The STOP FREQUENCY upper limit is 20 GHz.

### **Equivalent SCPI Command**

There are no equivalent SCPI commands for flatness correction functions, however, the MEM:TABL:FREQ and MEM:TABL:LOSS commands can be used to directly enter frequency and correction factor data points into a flatness correction table.

## See Also

To Use the Flatness Correction Routine

START FREQ

POINTS

CALIB FLATCOR

FLATCOR On Off

MEMory:TABLE:FREQuency

MEMory:TABLE:LOSS[:MAGNitude]





## Modultn

Selecting the Modulation menu accesses the following functions if your instrument does not contain Option 1E2:

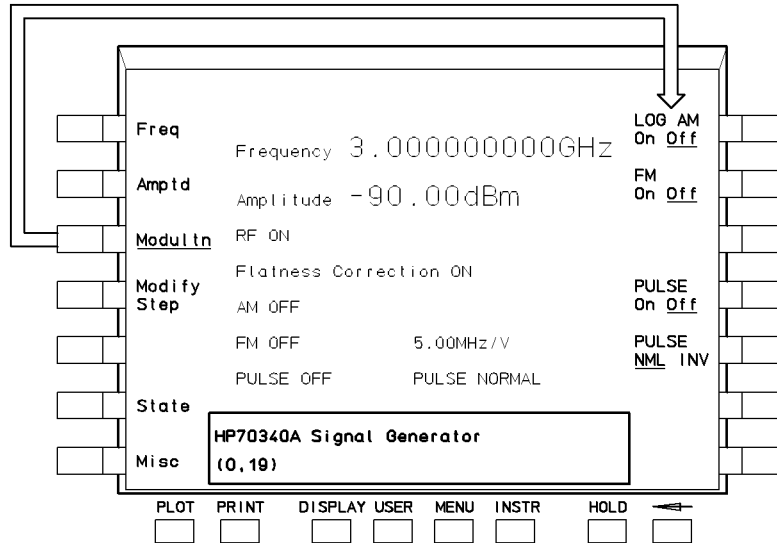

**Figure 5-5. Modulation Menu Structure**

If your signal generator has Option 1E2, the Modulation menu accesses the following functions which include internal pulse modulation functions:

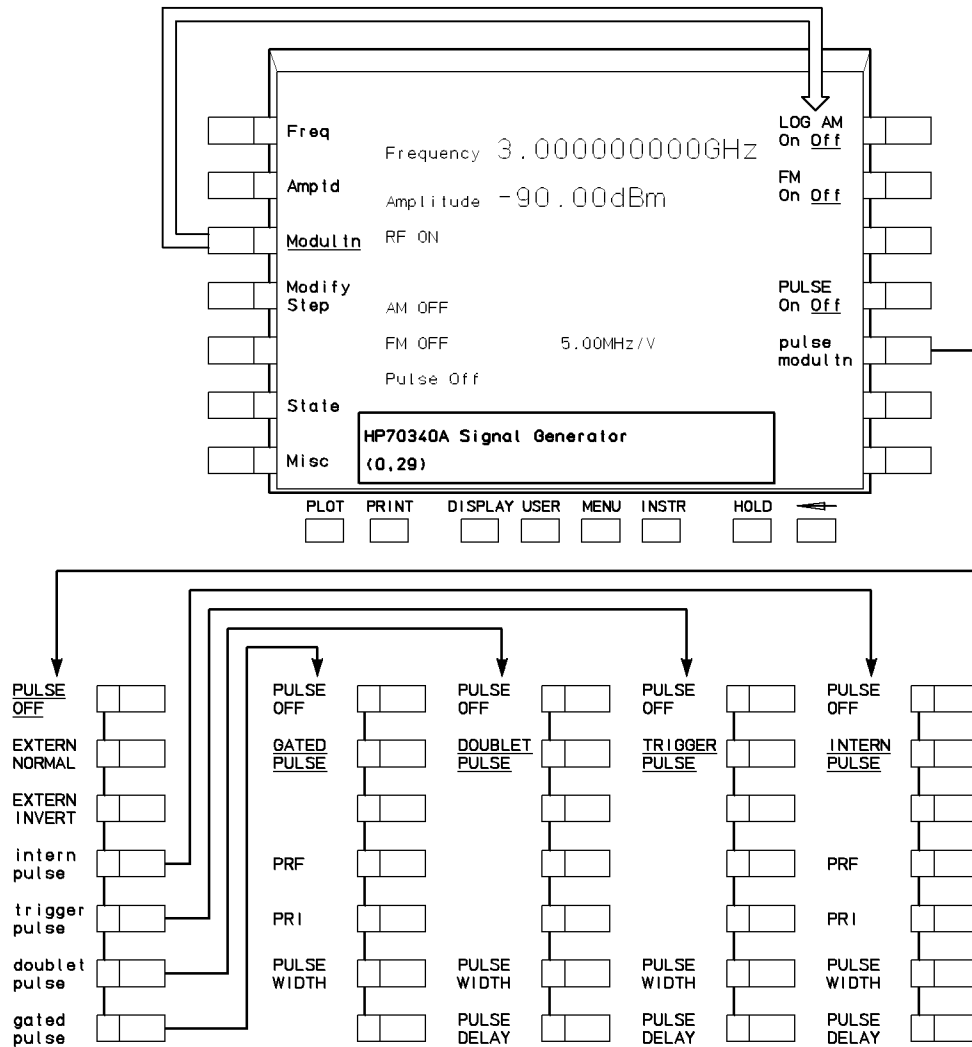

Figure 5-6. Modulation Menu Structure- Option 1E2

### FM Sensitivity

When **Modultn** is selected, FM sensitivity is displayed:

FM Sens 5.00 MHz/V

FM sensitivity is a ratio of the frequency deviation from the carrier per unit change of the modulating signal amplitude. In the signal generator, it is displayed as the carrier deviation per volt.

FM Sensitivity cannot be selected or changed. It is displayed due to the fact that FM sensitivity is a function of carrier frequency. See the FM section of Chapter 4, “Specifications and Options,” for details.

---

#### Note

When a frequency multiplier is used at the signal generator output, the sensitivity displayed is multiplied by the multiplier value. For example, if the multiplier value is set to 2 and the carrier is set to 30 GHz (2×15 GHz), the sensitivity displayed is 10.0 MHz/V (2×5 MHz/V).

---

## Equivalent SCPI Command

There is no equivalent command for the **Modul<sup>tn</sup>** softkey. However, you can determine the current FM Sensitivity with the following query:

**FM:SENS?**

*returns the current FM Sensitivity*

---

## DOUBLET PULSE

If your instrument has Option 1E2, selecting `Modultn`, `pulse modultn`, `doublet pulse`, and then `DOUBLET PULSE` (DOUBLET PULSE MODULATION) toggles doublet pulse modulation on and off.

---

The `INSTR PRESET` (`I-P`) state of this function is off.

When DOUBLET PULSE MODULATION is turned on, the softkey is underscored, and the display indicates “Pulse Internal Doublet” along with the current value of PULSE WIDTH and PULSE DELAY.

### Doublet Pulse Mode

When DOUBLET PULSE modulation is used, each trigger event will produce two pulses at the **RF OUTPUT** connector. The first pulse will follow the external trigger signal that is applied to the **PULSE/TRIG IN, GATE IN** connector. The second pulse will have delay and width parameters as set via the front panel or with programming commands. Pulse delay is measured from the leading edge of the external trigger signal. Figure 5-7 summarizes the timing characteristics of DOUBLET PULSE mode.

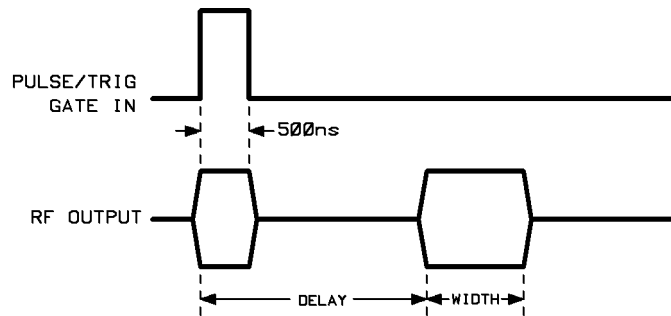

Figure 5-7. Doublet Pulse Mode Timing

### Equivalent SCPI Commands

`PULM:SOUR INT` sets pulse source to internal.  
`PULS:DOUB ON` turns doublet pulse mode on.  
`PULM:STAT ON|OFF` turns pulse modulation on or off.

### See Also

`PULSE DELAY`

`[SOURce[1]:]PULM:SOURce`

`[SOURce[1]:]PULM:STATe`

`[SOURce[1]:]PULSe:DOUBle[:]STATe]`

`PULSE WIDTH`

---

## EXTERN INVERT

If your instrument has Option 1E2, selecting **Modul<sup>tn</sup>**, **pulse modul<sup>tn</sup>**, **EXTERN INVERT** (EXTERNAL INVERTED) turns external inverted pulse modulation on and off.

---

The **INSTR PRESET** (**(-P)**) state for this function is not selected (off).

EXTERNAL INVERTED pulse modulation is on when the softkey is underscored and the display indicates “Pulse External Inverted.”

For Pulse modulation specifications, see Chapter 4, “Specifications and Options.”

### Equivalent SCPI Command

PULM:SOUR EXT

*sets pulse source to external.*

PULM:EXT:POL INV

*sets external pulse polarity to inverted.*

PULM:STAT ON|OFF

*turns pulse modulation on and off*

## See Also

[SOURce[1]:]PULM:STATe  
[SOURce[1]:]PULM:SOURce  
[SOURce[1]:]PULM:EXTernal:POLarity  
TRIGger:SOURce Command

EXTERN NORMAL

PULSE OFF

“To Generate External Pulse Modulation”  
EXT PULSE Connector

---

## EXTERN NORMAL

If your instrument has Option 1E2, selecting **Modul<sup>tn</sup>**, **pulse modul<sup>tn</sup>**, **EXTERN NORMAL** (EXTERNAL NORMAL) turns external noninverted pulse modulation on and off.

---

The **INSTR PRESET** (**(-P)**) state for this function is not selected (off).

EXTERNAL NORMAL pulse modulation is on when the softkey is underscored and the display indicates “Pulse **External**.”

For Pulse modulation specifications, see Chapter 4, “Specifications and Options.”

### Equivalent SCPI Command

PULM:SOUR EXT

*sets pulse source to external.*

PULM:EXT:POL NORM

*sets external pulse polarity to non-inverted.*

PULM:STAT ON|OFF

*turns pulse modulation on and off*

## See Also

[SOURce[1]:]PULM:STATe  
[SOURce[1]:]PULM:SOURce  
[SOURce[1]:]PULM:EXTernal:POLarity  
TRIGger:SOURce Command

EXTERN INVERT

PULSE OFF

“To Generate External Pulse Modulation”  
EXT PULSE Connector



---

## FM On Off

Pressing the **Modul<sup>tn</sup>** menu and then the **FM On Off** softkey toggles frequency modulation between **On** and **Off** states.

---

The state of FM On/Off is indicated by underscoring **On** or **Off** in the softkey.

The **(INSTR PRESET) (L-P)** state for this function is **Off**.

Note that FM Sensitivity is not selectable. FM Sensitivity changes with the carrier frequency. For FM specifications, see Chapter 4, “Specifications and Options.”

### Equivalent SCPI Command

**FM:STAT ON|OFF**

*turns frequency modulation on and off*

### See Also

**FM TYPE AC DC**

**EXT FM Connector**

**Modul<sup>tn</sup>**

[SOURce[1]:]FM:STATe Command

[SOURce[1]:]FM:COUPling Command

[SOURce[1]:]FM:SENSitivity Command

“Generating a Frequency Modulated Signal”

## GATED PULSE

If your instrument has Option 1E2, selecting `Modultn`, `pulse modultn`, `gated pulse`, and then `GATED PULSE` (GATED PULSE MODULATION) toggles gated pulse modulation on and off.

The `(INSTR PRESET)` (`(I-P)`) state of this function is off.

When GATED PULSE MODULATION is turned on, the softkey is underscored, and the display indicates “Pulse Gated” along with the current value of PULSE WIDTH, PULSE REPETITION FREQUENCY, and PULSE REPETITION INTERVAL.

### Internal Gated Pulse Mode

When the rising edge of a valid gate signal is applied to the **PULSE/TRIG/GATE IN** connector, a pulse train will appear at the signal generator **RF OUTPUT** connector with PULSE WIDTH and PULSE REPETITION FREQUENCY parameters as set via the front panel menus or with programming commands. When the falling edge of the gate signal is sensed at the **PULSE/TRIG/GATE IN** connector, the pulse train will cease. If the falling edge of the gate signal occurs in the middle of a pulse at the **RF OUTPUT** connector, the last pulse will complete before the pulse train ceases. Once the falling edge of the gate signal is sensed, a time interval equal to the PULSE REPETITION INTERVAL ( $\frac{1}{PRF}$ ) must elapse before another rising edge at the **PULSE/TRIG/GATE IN** connector will be valid. Figure 5-8 summarizes the critical timing characteristics of internal gated pulse mode.

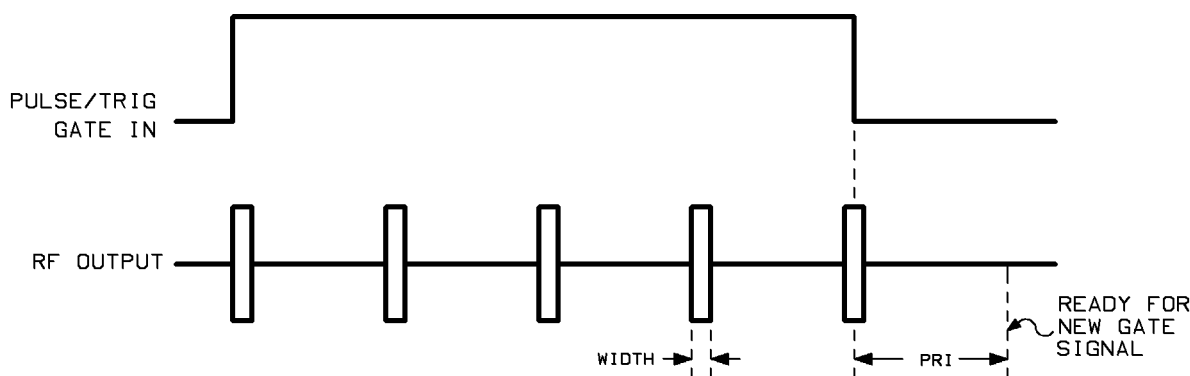

Figure 5-8. Internal Gated Pulse Mode Timing

### Equivalent SCPI Commands

|                                      |   |
|--------------------------------------|---|
| <code>PULM:SOUR INT</code>           | <i>sets pulse source to internal.</i>                     |
| <code>TRIG:SOUR EXT</code>           | <i>sets pulse trigger source to external (triggered).</i> |
| <code>TRIG:STOP:SOUR EXT</code>      | <i>sets pls trigger stop srce to external</i>             |
| <code>PULS:DOUB OFF</code>           | <i>turns doublet pulse mode off.</i>                      |
| <code>PULM:STAT <u>ON</u> OFF</code> | <i>turns pulse modulation on or off.</i>                  |

## See Also

PRF

PRI

PULSE WIDTH

---

## INTERN PULSE

If your instrument has Option 1E2, selecting `Modultn`, `pulse modultn`, `intern pulse`, and then `INTERN PULSE` (INTERNAL PULSE MODULATION) toggles internal pulse modulation on and off.

---

The `(INSTR PRESET)` `(I-P)` state of this function is off.

When INTERNAL PULSE MODULATION is turned on, the softkey is underscored, and the display indicates “Pulse Internal.”

The functions PRF, PRI, PULSE WIDTH, and PULSE DELAY set parameters for internal pulse modulation. The function PULSE OFF turns internal and any other pulse modulation off.

### Equivalent SCPI Commands

|                                      |  |
|--------------------------------------|--|
| <code>PULM:SOUR INT</code>           | <i>sets pulse source to internal.</i>                          |
| <code>TRIG:SOUR IMM</code>           | <i>sets pulse trigger source to immediate (non-triggered).</i> |
| <code>PULS:DOUB OFF</code>           | <i>turns doublet pulse mode off.</i>                           |
| <code>PULM:STAT <u>ON OFF</u></code> | <i>turns pulse modulation on or off.</i>                       |

## See Also

PRF

PRI

PULSE WIDTH

PULSE DELAY

[SOURCE[1]:]PULM:SOURce

[SOURCE[1]:]PULM:STATe

TRIGger[SEQuence[1]:]STARt]:SOURce

---

## LOG AM On Off

Pressing the **Modul<sup>tn</sup>** menu and then the **LOG AM On Off** (LOGARITHMIC AM On/Off) softkey activates the exponentially scaled amplitude modulation function.

---

The **INSTR PRESET** (**I-P**) condition for this function is off.

s Amplitude modulation allows you to continuously and exponentially vary the **RF OUTPUT** of the signal generator at a rate determined by **EXT AM** input.

Logarithmic AM toggles between **On** and **Off** as indicated by underscoring **On** or **Off** on the softkey.

When the signal generator is in Log AM mode, the **EXT AM** input accepts 0 to 6V. For every 1V input, the **RF OUTPUT** level decreases by 10 dB. For example, +3V causes a 30 dB attenuation in the RF Output signal. The full range of attenuation varies from 0 dB to 60 dB. Negative voltage inputs have no effect on the RF Output signal (ie. 0 dB attenuation). For complete Log AM specifications, see Chapter 4, “Specifications and Options.”

### Equivalent SCPI Command

**AM:STAT ON|OFF** *turns AM on and off*

## **See Also**

**EXT AM** Connector,  
[SOURce[1]:]AM:STATe Command  
“To Generate a Log AM Signal.”

---

## PRF

If your instrument has Option 1E2, the **PRF** (PULSE REPETITION FREQUENCY) function enables you to modify the pulse repetition frequency. The PRF function is used during internal pulse modulation and gated pulse modulation. This function is accessed by selecting **Modultn**, **pulse modultn**, and **intern pulse** or **gated pulse**.

---

The **INSTR PRESET** (**I-P**) state for this function is 10 kHz, and the preset increment value is 100 Hz.

When the pulse repetition frequency is entered, the text “PRF XXX” appears on the display where “XXX” is the entered value and the appropriate units suffix.

The accepted range for entries is from a minimum of 2.5 Hz to a maximum that is limited according to the carrier frequency set with the CW FREQUENCY function. The limits are as follows:

**Maximum Specified PRF**

| Carrier Frequency  | Maximum Specified PRF |
|--------------------|-----------------------|
| 10 MHz to 128 MHz  | 0.1 MHz               |
| 128 MHz to 500 MHz | 1 MHz                 |
| 500 MHz and up     | 3.3 MHz               |

---

### Notes

1. The maximum PRF limits in the above table apply to the HP xxx only. The maximum PRF limit for the HP xxx is 3.3 MHz over the entire carrier frequency range.
2. The value for pulse width can not be greater than the value for  $\frac{1}{PRF}$ .

---

If a PRF entry is made that is not within the allowable range, the pulse characteristics will be out of specification and an error message will be generated.

The resolution for PRF can be found by rounding the reciprocal of PRF (1/PRF or PRI) to the nearest 25 ns and then taking the reciprocal of that value. For example, assume a PRF of 432 kHz is needed. The reciprocal of 432 kHz is 1/432 kHz or 2315 ns. This value rounded to the nearest 25 ns is 2325 ns. Taking the reciprocal of 2325 ns is 1/2325 ns or 430.107526 kHz. Therefore, if you enter a PRF of 432 kHz, the display will show 432 kHz but the actual PRF generated by the instrument will be 430.107526 kHz. The preset value for PRF is 10 kHz. The preset **↑** **↓** increment value is 100 Hz.

---

### Note

Changing the PRF parameter automatically causes the PRI (pulse repetition interval) parameter to change since these two parameters are reciprocals of each other.

---



## Equivalent SCPI Command

`PULS:FREQ prf` sets the pulse repetition frequency as defined by the “prf” parameter.

## See Also

`PRI`

`PULSE DELAY`

`PULSE WIDTH`

`INTERN PULSE`

`GATED PULSE`

`[SOURce[1]:]PULSe:FREQuency`

---

## PRI

If your instrument has Option 1E2, the **PRI** (PULSE REPETITION INTERVAL) function enables you to modify the pulse repetition interval. The PRI function is used during internal pulse modulation and gated pulse modulation. This function is accessed by selecting **Modultn**, **pulse modultn**, and **intern pulse** or **gated pulse**.

---

The **(INSTR PRESET)** **(I-P)** state for this function is 100  $\mu$ s, and the preset increment value is 1  $\mu$ s.

When the pulse repetition interval is entered, the text “PRI XXX” appears on the display where “XXX” is the entered value and the appropriate units suffix.

The accepted range for entries is from a maximum of 419 ms to a minimum that is limited according to the carrier frequency set with the CW FREQUENCY function. The limits are as follows:

**Minimum Specified PRI**

| Carrier Frequency  | Minimum Specified PRI |
|--------------------|-----------------------|
| 10 MHz to 128 MHz  | 10 $\mu$ s            |
| 128 MHz to 500 MHz | 1 $\mu$ s             |
| 500 MHz and up     | 0.3 $\mu$ s           |

---

### Notes

1. The minimum PRI limits in the above table apply to the HP xxx only. The minimum PRI limit for the HP xxx is 0.3  $\mu$ s over the entire carrier frequency range.
2. The value for pulse width can not be greater than the value for PRI.

---

The resolution for PRI entries is 25 ns; entries with resolution finer than 25 ns will be rounded to the nearest 25 ns. If a PRI entry is made that is not within the allowable range, the pulse characteristics will be out of specification and an error message will be generated. The preset value for PRI is 100  $\mu$ s. The preset up/down arrow increment value is 1  $\mu$ s.

---

### Note

Changing the PRI parameter automatically causes the PRF (pulse repetition frequency) parameter to change since these two parameters are reciprocals of each other.

---

## Equivalent SCPI Command

PULS:PER pri sets the pulse repetition interval as defined by the “pri” parameter.

## See Also

PRF

PULSE DELAY

PULSE WIDTH

INTERN PULSE

GATED PULSE

[SOURce[1]:]PULSe:FREQuency



---

## PULSE DELAY

If your instrument has Option 1E2, the **PULSE DELAY** function enables you to modify the pulse delay. The **PULSE DELAY** function is used during internal, internal triggered, and doublet pulse modulation. This function is accessed by selecting **Modultn**, **pulse modultn**, and **intern pulse**, **trigger pulse**, or **doublet pulse**.

---

When in the pulse modulation menus, the **PULSE DELAY** parameter is displayed as “Delay **XXX**” where “**XXX**” is the entered value and the appropriate units suffix.

The **INSTR PRESET** (**I-P**) state for this function is 1  $\mu$ s. The preset   increment value is 25 ns.

The allowable range for entries is 0 ns to 419 ms with a resolution of 25 ns;. Entries with resolution finer than 25 ns will be rounded to the nearest 25 ns. If a **PULSE DELAY** entry is made that is not within the allowable range, the delay will be set to the upper or lower limit. The allowable range for up/down arrow increments is 25 ns to 419 ms with 25 ns resolution.

The allowable range for entries is as shown in the following table.

**Allowable Delay Range**

| <b>Internal Pulse Mode</b> | <b>Triggered or Doublet Pulse Mode</b>       |
|----------------------------|--|
| $\pm 419$ ms               | +225 ns minimum +419 ms maximum <sup>1</sup> |

<sup>1</sup> In triggered pulse mode, the sum of pulse width and pulse delay can not exceed 419 ms.

### Positive/Negative Delay

When in internal pulse modulation mode, the delay parameter can be positive or negative. Delay is the time between the rising edge of the synchronizing pulse at the **PULSE SYNC OUT** connector and the rising edge of the RF pulse at the **RF OUTPUT** connector. When the delay is positive, the synchronizing pulse precedes the RF pulse by the value of the delay. When the delay is negative, the RF pulse precedes the synchronizing pulse by the value of the negative delay.

### Equivalent SCPI Command

**PULS:DEL delay** sets pulse delay as in “*delay*” parameter

### See Also

**PULSE DELAY**

**PRF**

**PRI**

[SOURce[1]:]PULSe:WIDTh

---

## pulse modultn

If your instrument as Option 1E2, selecting the **Modultn** menu and then the **pulse modultn** menu accesses six modes of pulse modulation: normal external, inverted external, internal, trigger, doublet, and gated.

---

Each pulse modulation mode is described under the following menu and function entries:

- EXTERNAL INVERTED
- EXTERNAL NORMAL
- internal pulse
- doublet pulse
- gated pulse
- trigger pulse

---

## PULSE NML INV

Selecting the **Modul<sup>tn</sup>** softkey menu and then the **PULSE NML INV** (PULSE NORMAL/INVERTED) softkey function toggles between normal and inverted external pulse modulation.

---

The **INSTR PRESET** (**I-P**) condition for this function is off.

The state of the PULSE NORMAL/INVERTED function is indicated by underscoring either **NML** or **INV** in the softkey.

When PULSE NORMAL/INVERTED is in the INVERTED state and PULSE On/Off is **On**, pulses at the **EXT PULSE** connector are inverted within the signal generator. This means that when the input signal is high, there is no power at the RF Output connector. When the input signal is low, there is power at the RF Output connector. PULSE NORMAL operation is the opposite of PULSE INVERTED operation.

### Equivalent SCPI Commands

PULM:SOUR EXT

*sets pulse source to external*

PULM:EXT:POL INV

*sets external pulse polarity to inverted*

PULM:STAT ON|OFF

*turns pulse modulation on or off*

## See Also

`PULSE On Off`

`EXTERN NORMAL`

`EXTERN INVERT`

**EXT PULSE** Connector

[SOURCE[1]:]PULM:EXTernal:POLarity Command

[SOURCE[1]:]PULM:SOURce Command

[SOURCE[1]:]PULM:STATe Command

“To Generate External Pulse Modulation”

---

## PULSE OFF

If your instrument has Option 1E2, the **PULSE OFF** (PULSE OFF) function is found under each pulse modulation menu and toggles external, internal, trigger, doublet, or gated pulse modulation on and off.

---

The **INSTR PRESET** (**(-P)**) state for this function is selected so that pulse modulation is off.

If the PULSE OFF function is not selected, then one of the following pulse modulation modes is on: EXTERNAL NORMAL pulse, EXTERNAL INVERTED pulse, INTERNAL PULSE, TRIGGER PULSE, DOUBLET PULSE, or GATED PULSE.

For Pulse modulation specifications, see Chapter 4, “Specifications and Options.”

### Equivalent SCPI Command

`PULM:STAT ON|OFF`

*turns pulse modulation on and off*



## See Also

[SOURce[1]:]PULM:STATe  
[SOURce[1]:]PULM:SOURce  
TRIGger:SOURce Command  
EXTERN NORMAL  
EXTERN INVERT  
INTERN PULSE  
TRIGGER PULSE  
GATED PULSE  
DOUBLET PULSE  
EXT PULSE Connector

---

## PULSE On Off

Pressing the **Modul<sup>tn</sup>** softkey menu and then the **PULSE On Off** softkey function toggles pulse modulation between **On** and **Off** states.

---

The **INSTR PRESET** (**I-P**) state for PULSE On/Off is **Off**.

The state of the PULSE On/Off function is indicated in the softkey by underscoring **On** or **Off**.

If your instrument does not have Option 1E2, the PULSE On/Off function turns *external* pulse modulation on and off. With this instrument configuration, you can invert pulses by selecting the PULSE NORMAL INVERT function.

If your instrument has Option 1E2, the PULSE On/Off function turns off all six pulse modulation modes: EXTERNAL NORMAL, EXTERNAL INVERTED, INTERNAL PULSE, TRIGGER PULSE, DOUBLET PULSE, and GATED PULSE.

For Pulse modulation specifications, see Chapter 4, “Specifications and Options.”

### Equivalent SCPI Command

PULM:STAT ON|OFF

*turns pulse modulation on and off*

## See Also

[SOURce[1]:]PULM:STATe Command

[SOURce[1]:]PULM:SOURce Command

TRIGger:SOURce Command

PULSE NML INV

EXTERN NORMAL

EXTERN INVERT

INTERN PULSE

TRIGGER PULSE

DOUBLET PULSE

GATED PULSE

EXT PULSE Connector

---

## PULSE WIDTH

If your instrument has Option 1E2, the **PULSE WIDTH** function enables you to modify the pulse width. The **PULSE WIDTH** function is used during internal, trigger, doublet, and gated pulse modulation. This function is accessed by selecting **Modultn**, **pulse modultn**, and any of the pulse modulation menus.

---

The **(INSTR PRESET)** **(I-P)** state for this function is 10  $\mu$ s and the increment value is 100 ns.

When in the pulse modulation menus, the **PULSE WIDTH** parameter is displayed as “Width XXX” where “XXX” is the entered value and the appropriate units suffix.

The allowable range for entries is 0 ns to 419 ms with a resolution of 25 ns;. Entries with resolution finer than 25 ns will be rounded to the nearest 25 ns. If a width entry is made that is greater than the upper limit, the value will be set to the upper limit.

- 
- Notes**
1. In triggered pulse mode, the sum of pulse width and pulse delay can not exceed 419 ms.
  2. The value for pulse width can not be greater than the value for PRI.
- 

The allowable range for up/down arrow increments is 25 ns to 419 ms with 25 ns resolution.

### Equivalent SCPI Command

**PULS:WIDT width** sets the pulse width as defined by the “width” parameter.

### See Also

**PULSE DELAY**

**PRF**

**PRI**

**[SOURce[1]:]PULSe:WIDTh**

---

## TRIGGER PULSE

If your instrument has Option 1E2, selecting `Modultn`, `pulse modultn`, `trigger pulse`, and then `TRIGGER PULSE` (TRIGGERED PULSE MODULATION) toggles trigger pulse modulation on and off.

---

The `INSTR PRESET` (`I-P`) state of this function is off.

When TRIGGERED PULSE MODULATION is turned on, the softkey is underscored, and the display indicates “Pulse Internal Triggered.”

When internal triggered pulse modulation is enabled, an RF pulse will occur at the **RF OUTPUT** connector whenever a valid trigger signal occurs at the **PULSE/TRIG IN, GATE IN** connector. The RF pulse will have pulse width and delay as set with the PULSE WIDTH and PULSE DELAY functions. Figure 5-9 summarizes the timing characteristics of internal triggered pulse mode.

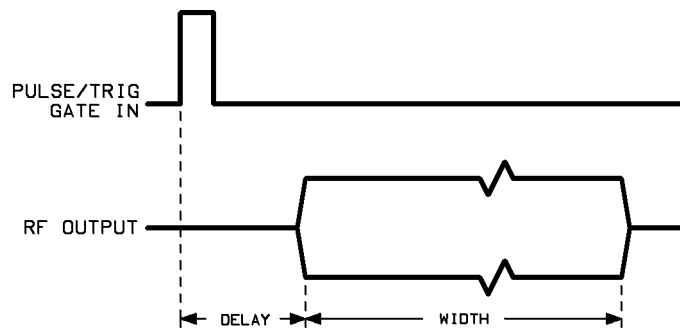

Figure 5-9. Internal Triggered Pulse Mode Timing

### Equivalent SCPI Commands

|                                      |  |
|--------------------------------------|--|
| <code>PULM:SOUR INT</code>           | <i>sets pulse source to internal</i>       |
| <code>TRIG:SOUR EXT</code>           | <i>enables triggered pulse mode</i>        |
| <code>TRIG:STOP:SOUR IMM</code>      | <i>sets trigger stop srce to immediate</i> |
| <code>PULS:DOUB OFF</code>           | <i>turns doublet pulse mode off</i>        |
| <code>PULM:STAT <u>ON OFF</u></code> | <i>turns pulse modulation on or off</i>    |

### See Also

Connectors

`PULSE DELAY`

`[SOURce[1]:]PULM:SOURce`

`[SOURce[1]:]PULM:STATe`

`TRIGger[:SEQuence[1]]:START[:SOURce`

`PULSE WIDTH`



## Modify Step

Selecting the **Modify Step** menu accesses the functions which control the step size of the currently active parameter.

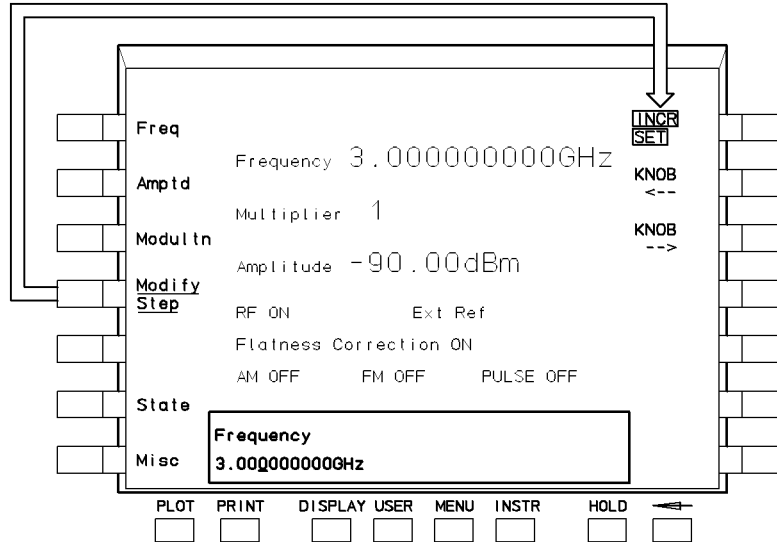

**Figure 5-10. Modify Step Menu Structure**

The **Modify Step** functions are used in conjunction with: CW FREQUENCY, AMPLITUDE, POWER METER READING, POWER METER ADDRESS, START FREQUENCY, STOP FREQUENCY, POINTS, LO FREQUENCY, OFFSET FREQUENCY, METER NODE, HARDWARE CONTROL ADDRESS, and HARDWARE CONTROL VALUE.

---

## INCR SET

Selecting the **Modify Step** menu and then the **INCR SET** (INCREMENT SET) function enables you to change the increment value for the current active parameter. The increment value is the value that the current parameter will be increased or decreased by when the  $\uparrow$  or  $\downarrow$  keys are used.

---

You will find the **INSTR PRESET** (**I-P**) increment value for each function under the function entry in this chapter.

If no function is currently active or the ENTRY HOLD function is active, pressing the  $\uparrow$  and  $\downarrow$  keys produces no effect.

### Equivalent SCPI Commands

Some examples of commands using the STEP parameter follow:

```
FREQ:STEP increment value;  
sets frequency increment value  
FREQ:MULT:STEP increment value;  
sets multiplier increment value  
POW:STEP increment value;  
sets power level increment value  
POW:ALC:PMET:STEP increment value;  
sets external power meter leveling increment value
```



## See Also

To Modify Data with the Arrow Keys

  keys

Knob





---

## **KNOB <--, KNOB -->**

Selecting the **Modify Step** menu and then the **KNOB <--** or **KNOB -->** function once moves the decimal position of the underscore to the left or right one place.

---

You will find the **INSTR PRESET** (**(-P)**) Knob increment value for each parameter under the pertinent menu or function entry in this chapter.

---

**Note** The digit above the underscore is only affected by turning the Knob, not by pressing the **(↑)** and **(↓)** keys.

---

If no function is currently active or the **ENTRY HOLD** function is active, pressing the **(↑)** and **(↓)** keys produces no effect.

### **See Also**

To Modify Data with the Knob

**INCR SET**

**Knob**

**ENTRY HOLD**

**HOLD**

## State

Selecting the **State** menu accesses the functions which allow you to store and recall instrument configurations to and from any of ten memory locations.

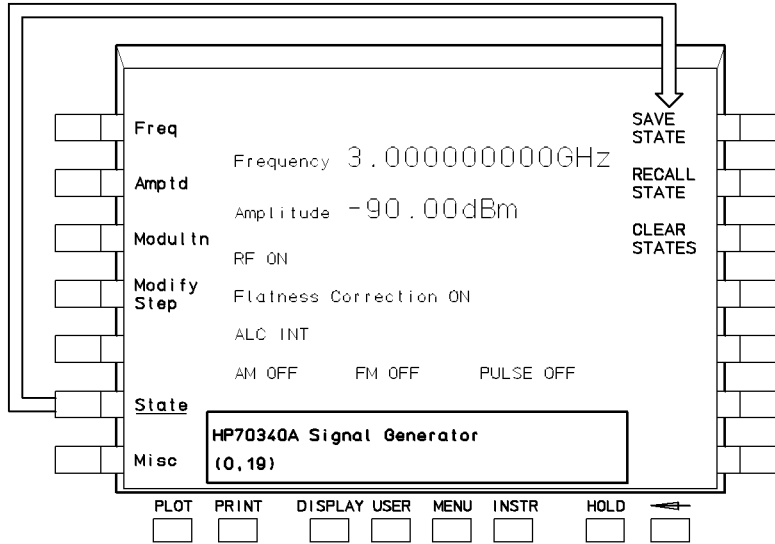

**Figure 5-11. State Menu Structure**

---

## CLEAR STATES

Selecting the **State** menu and then the **CLEAR STATES** function, clears all of the **SAVE STATE** registers and places **(INSTR PRESET)** **(I-P)** settings in them.

---

When you select **CLEAR STATES**, the display returns the **CLEAR STATES** and the **prev menu** softkeys. Selecting the **CLEAR STATES** function a second time initiates the function. Selecting the **prev menu** softkey returns you to the State menu without clearing state memory .

The **CLEAR STATES** function momentarily appears in inverse video indicating that the signal generator clears state memory. When memory is cleared, the display returns to the State menu.

### See Also

**SAVE STATE**

**RECALL STATE**

**ERASE MEMORY**

---

## RECALL STATE

Selecting the **State** menu and then the **RECALL STATE** function allows you to recall a stored instrument state from one of ten register locations.

---

The allowable range for register locations is 0 through 9. When **RECALL STATE** is selected, the text “Recall State from Reg X” appears on the display. Once you press a valid numeric key (0 through 9) and the **ENTER** softkey, the instrument state is recalled from the location indicated by the numeric key pressed.

If nothing has been stored in the register that is recalled, the **INSTR PRESET** (**I-P**) state is recalled.

### Equivalent SCPI Command

\*RCL register

*recalls a previously stored instrument state from the register determined by “register”*

### See Also

\*RCL Command

**SAVE STATE**

\*SAV Command

“To Save and Recall States”

---

## SAVE STATE

Invoking the **SAVE STATE** function (pressing **State** and then **SAVE STATE**) allows you to save the current instrument state in one of ten register locations.

---

The allowable range for register locations is 0 through 9. When **SAVE STATE** is selected, the text “**Enter Save State 0-9**” is shown on the instrument display. Once you press a valid numeric key (0 through 9) and the **ENTER** softkey, the instrument state is stored in the location indicated by the numeric key pressed, and the display reverts back to the previous menu.

Saving the instrument state to a given register location writes over any instrument state previously stored in that register.

All user settings that are affected by **INSTR PRESET** (**I-P**) are saved when you enable the **SAVE STATE** function. Flatness correction tables are *not* saved. Refer to the **FLATNESS DATA x** function for information on how to calibrate and automatically save flatness correction information.

### Equivalent SCPI Command

\*SAV register number

*saves the signal generator state to the register defined by “register” parameter*

## See Also

RECALL STATE

FLATCOR SAVE

\*SAV Command

\*RCL Command

“To Save and Recall States”





## Misc

Pressing the Miscellaneous menu softkey accesses the following functions and submenus:

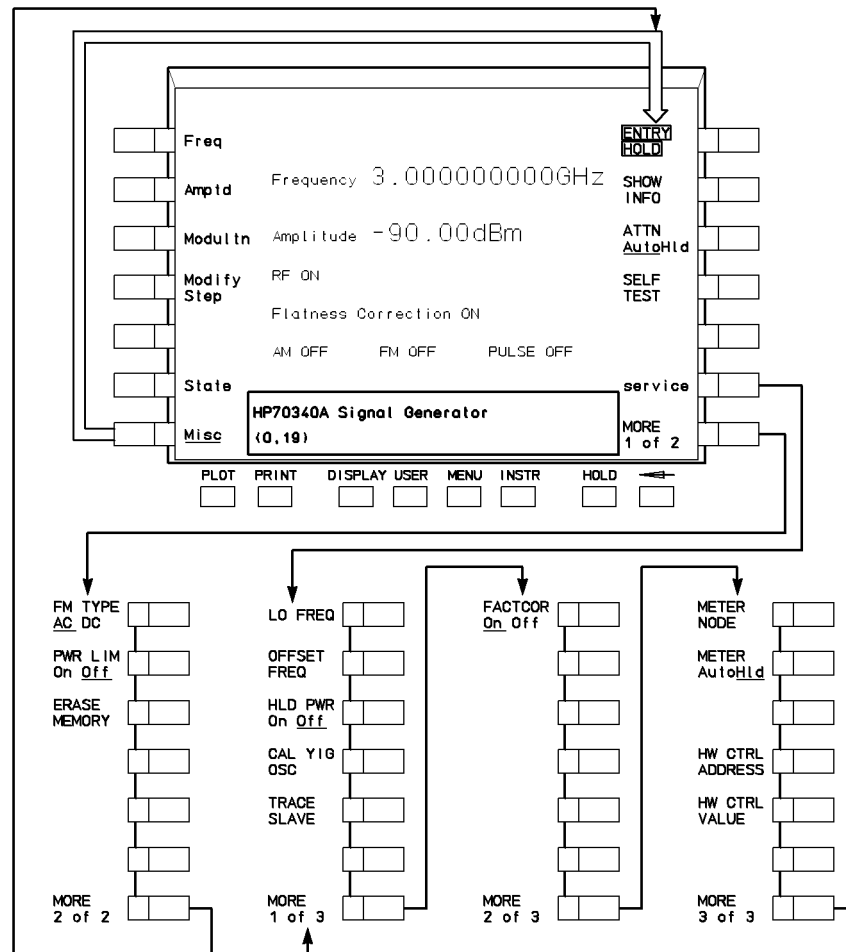

Figure 5-12. Miscellaneous Menu Structure

## ATTEN AutoHld

Selecting the softkeys: **Misc** and **ATTEN AutoHld** (ATTENUATOR Automatic/Hold) toggles the output step attenuator between **Auto** (automatically switching) and **Hld** (locked to current setting) modes.

The softkey toggles between states as indicated by underscoring **Auto** or **Hld**.

The **INSTR PRESET** (**I-P**) state of ATTENUATOR Automatic/Hold is **Auto**.

## Applications

The ATTENUATOR Automatic/Hold function can be used to extend the vernier range to prevent the step attenuator from switching between two attenuator settings. Locking the step attenuator (HLD mode) keeps the attenuator from switching between the two levels as leveled power is varied above and below the threshold level, thus saving wear on the attenuator. Refer to the specification table in this manual for the level at which the attenuator switches.

## Advantages

Locking the step attenuator prevents switching between two levels when the leveled output power is set near an attenuator switching threshold.

## Disadvantages

When the step attenuator is locked, the output power dynamic range is limited to the vernier range at the current output frequency. Locking the step attenuator typically extends the lower limit of the vernier range by 5 dB. The upper limit of the vernier range is the signal generator maximum output power which changes with frequency. The minimum dynamic range when the attenuator hold function is on is typically 19 dB.

---

**Note** The `ATTEN AutoHld` function is only available with the instrument Option 1E1 and will not activate when the signal generator is in the external diode detector leveling or external power meter leveling mode.

---

## Equivalent SCPI Command

`POW:ATT:AUTO ON|OFF`

*sets the mode of the attenuators to automatic or manual*

## See Also

POW:ATTenuator:AUTO Command

---

## CAL YIG OSC

Selecting the CAL YIG OSC (CALIBRATE YIG OSCILLATOR) function under the service menu calibrates both of the signal generator Yig oscillators. This function is *only* required when certain repairs are performed on the instrument. Refer to *HP 70340A Service Guide*.

---

Note that selecting the ABORT function during the calibration routine will abort the routine and retain the old calibration data.

### Equivalent SCPI Command

CAL:YIG OSC *Calibrates both of the Yig oscillators.*

---

## ENTRY HOLD

Pressing the **Misc** menu and then the **ENTRY HOLD** softkey disables the parameter entry keys which include: numeric keypad, the **↑** **↓** (step arrow) keys, the Knob, **Knob<--** softkey, **Knob-->** softkey, and **INCR SET** softkey.

---

When the ENTRY HOLD function is active, it appears in inverse video and the display data entry box indicates:

“HP70340A signal generator ”

### Application

The ENTRY HOLD function is useful when you want to avoid parameter changes to the signal generator functions. For example, assume that CW FREQUENCY is the active function. If you press the **↑** **↓** (step arrow) keys or the Knob (whether accidentally or purposefully), the CW frequency changes. Once you enter the CW frequency that you want, you can select the ENTRY HOLD function to prevent unintentional changes to the parameter.

To return to normal entry mode, select any of the following functions: CW FREQUENCY, AMPLITUDE, FREQUENCY MULTIPLIER, SAVE STATE, RECALL STATE, POWER METER ADDRESS, START FREQUENCY, STOP FREQUENCY, STEP FREQUENCY, METER NODE, HARDWARE CONTROL ADDRESS, HARDWARE CONTROL VALUE.

---

**Note** The **HOLD** key on the HP 70004A and the HP 70206A displays performs the same function as the **ENTRY HOLD** softkey.

---

### See Also

**↑** **↓** keys

Knob

Numeric Keypad

**HOLD**

---

## ERASE MEMORY

---

Selecting the softkeys **Misc** and **ERASE MEMORY** allows you to set all memory locations to the **(INSTR PRESET) (I-P)** state. **ERASE MEMORY** clears all of the stored settings and flatness correction tables. It does not, however, erase memory locations which contain factory set calibration information.

---

When you select this function, the signal generator returns the **ERASE MEMORY** and **prev menu** functions. When you select **ERASE MEMORY** a second time, the softkey appears in inverse video while the signal generator overwrites state information. When the signal generator finishes overwriting memory, the display returns the Miscellaneous menu. Selecting the **prev menu** function returns the Miscellaneous menu **without** erasing memory.

Enabling ERASE MEMORY causes the signal generator to return all functions to the **(INSTR PRESET)** state. Note that **SAVE** and **RECALL** registers are cleared and FLATNESS CORRECTION data is erased.

### Application

The ERASE MEMORY function is useful when you remove the signal generator from a secure area since the setup history of the instrument is erased.

### Equivalent SCPI Command

`MEM:RAM:INIT` *erases application specific memory*

### See Also

**SAVE STATE**

**RECALL**

**(INSTR PRESET) (I-P)**

**FLATCOR On Off**

**MEMory:RAM:INITialize[:ALL] Command**

---

## FACT COR On Off

Selecting **FACT COR On Off** (FACTORY CORRECTION) under the **Misc** and **service** menus turns the factory attenuator correction data on or off. Refer to the *HP 70340A Service Guide* for more information.

---

Whether FACTORY CORRECTION is on or off is indicated by underscoring **On** or **Off**.

The **INSTR PRESET** (**I-P**) setting for this function is on.

---

## FM TYPE AC DC

Selecting the **Misc** and **FM TYPE AC DC** softkeys allows you to toggle frequency modulation between **AC** and **DC** coupling.

---

Whether your signal is AC FM or DC FM is indicated by underscoring **AC** or **DC** in the **FM TYPE AC DC** softkey.

The signal generator **(INSTR PRESET)** **(I-P)** condition for this function is **AC**.

When FM TYPE is set to AC (the preset state), the signal generator circuitry is configured so that the **EXT FM** connector will accept a modulating signal with a minimum rate of 1 kHz. When FM TYPE is set to DC, the **EXT FM** connector will accept a modulating signal with a minimum rate of 0 Hz (DC). Maximum FM deviation does not change.

### Advantage

When FM TYPE DC is selected, the modulation index is unlimited.

modulation index = peak deviation/modulation rate

Where modulation rate can range down to 0 Hz (DC).

### Disadvantage

When FM TYPE DC is enabled, the internal phase locked loop circuit is disabled, causing the output frequency accuracy and stability to be degraded.

### Equivalent SCPI Command

```
FM:COUP AC|DC
sets FM coupling mode
```

### See Also

**FM On Off**

[SOURce[1]:]FM:COUPLing Command

[SOURce[1]:]FM:STATe Command

“To Generate an FM Signal”

---

## HLD PWR On Off

Selecting **Misc**, **service**, and **HLD PWR On Off** (HOLD POWER On/Off) invokes a service function which holds the ALC loop at its current power setting so that the microwave chain can be broken and internal power levels of the RF and microwave subsection can be measured. Refer to *HP 70340A Service Guide*.

The **INSTR PRESET** (**[-P]**) condition for this function is off.

### Equivalent SCPI Command

DIAG:ALC:HOLD ON|OFF

*turns ALC loop power hold on or off*

### See Also

DIAGnostic:ALC:HOLD[:STATe] Command



---

## HW CTRL ADDRESS

Selecting the softkey sequence **Misc**, **service**, and **HW CTRL ADDRESS** (HARDWARE CONTROL ADDRESS) invokes a service function which addresses the digital device at the address entered and, in conjunction with **HW CTRL VALUE**, allows control of the signal generator digital circuitry. The *HP 70340A Service Guide* troubleshooting procedures explain how to use this function as it applies to a particular failure.

### Equivalent SCPI Command

DIAG:IBUS destination address, value  
*Sets the hardware location "destination" to "value"*

### See Also

DIAGnostic:IBUS Command

---

## HW CTRL VALUE

Selecting **Misc**, **service**, and **HW CTRL VALUE** (HARDWARE CONTROL VALUE) invokes a service function which sets the addressed digital device to the value entered and, thus, allows control of the signal generator digital circuitry. The *HP 70340A Service Guide* troubleshooting procedures explain how to use this function as it applies to a particular failure.

### Equivalent SCPI Command

DIAG:IBUS destination address, value  
*Sets the hardware location "destination" to "value"*

### See Also

DIAGnostic:IBUS Command

---

## LO FREQ

Selecting **Misc**, **service**, and **LO FREQ** (LOCAL OSCILLATOR FREQUENCY) invokes a service function which displays or sets the signal generator internal LO phase locked loop frequency to a value between 300 and 360 MHz. The *HP 70340A Service Guide* troubleshooting procedures explain how to use this function as it applies to a particular failure.

---

Note that changing the LO frequency changes the signal generator output frequency.

### Equivalent SCPI Command

DIAG:LO:FREQ frequency

*sets the signal generator LO phase locked loop frequency*

### See Also

#### OFFSET FREQ

DIAGnostic:LO:FREQency Command

DIAGnostic:OFFSet:FREQency Command

---

## METER NODE

Selecting **Misc**, **service**, and **METER NODE** invokes a service function which allows you to specify the node where the signal generator internal voltmeter/frequency counter will make a measurement. The *HP 70340A Service Guide* troubleshooting procedures explain how to use this function as it applies to a particular failure.

### Equivalent SCPI Command

DIAG:ABUS? node *specifies the node where the instrument's internal voltmeter/frequency counter makes a measurement and returns the value of the node*

### See Also

DIAGnostic:ABUS? Command

---

## OFFSET FREQ

Selecting **Misc**, **service**, and **OFFSET FREQ** (OFFSET FREQUENCY) invokes a service function which allows you to display or set the signal generator offset phase locked loop frequency to a value between 13 to 26.5 MHz. The *HP 70340A Service Guide* troubleshooting procedures explain how to use this function as it applies to a particular failure.

---

**Note** Changing the offset signal generator frequency changes the instrument's RF Output frequency and can cause the frequency to go unlocked. Thus, this is not a recommended mode of operation unless the instrument is being serviced.

---

### Equivalent SCPI Command

DIAG:OFFS:FREQ frequency

*sets signal generator offset phase locked loop frequency to the value that you specify*

### See Also

DIAGnostic:OFFSet:FREQuency Command

DIAGnostic:LO:FREQuency Command

---

## PWR LIM On Off

Selecting the **Misc** menu and then the **PWR LIM On Off** (AVERAGE POWER LIMIT On/Off) function enables or disables the average power limit function.

---

When **PWR LIM On Off** is enabled, the softkey appears in inverse video and the display shows the following:

AVG POWER LIMIT XXX

where XXX is the current state of the average power limit function (either ON or OFF).

The **INSTR PRESET** (**I-P**) state for this function is off.

The AVERAGE POWER LIMIT On/Off function is used to protect average power sensitive devices during pulse modulation.

---

**Note** This function is only available if option 1E1 (step attenuator) is installed.

---

## Application

The AVERAGE POWER LIMIT function can be used during pulse modulation to protect devices sensitive to high average power. When the output power level or frequency of the signal generator is changed during pulse modulation, the internal leveling algorithm causes the RF output to be momentarily switched to CW to enable the instrument's circuitry to sample the signal level and make a correction. If the output of the signal generator is connected to circuitry that is average power-sensitive, damage to the circuitry could result during this CW calibration. When in internal leveling mode, the CW calibration is approximately 30 ms.

When the AVERAGE POWER LIMIT function is off (the preset condition), the CW calibration will follow output power level and frequency changes. The CW calibration will also occur the first time pulse or logarithmic amplitude modulation is enabled. When AVERAGE POWER LIMIT is on, the instrument's internal step attenuator will switch in 90 dB of attenuation during the CW calibration. This will protect power-sensitive circuitry connected to the **RF OUTPUT** connector, but will cause extra wear on the step attenuator. Turning the function on will also cause a momentary drop in signal power and, thus, will lengthen frequency and power level switching times to 70 ms.

## Pulsed Power Pre-Calibration Program

The AVERAGE POWER LIMIT function causes the internal step attenuator to switch in 90 dB of attenuation whenever frequency or power level is changed. This causes extra wear on the step attenuator.

When you know the various frequencies and power levels that you will be using in a test routine, the following program can be used to gather the CW calibration values for frequency/power level pairs. When in special pulse modulation mode, the calibration values can be sent for each frequency/power level pair and the CW calibration is eliminated. This program provides an alternative to turning the AVERAGE POWER LIMIT function on and, therefore, minimizes wear on the step attenuator.

When the calibration portion of the program is run, you should disconnect average power sensitive circuitry from the RF OUTPUT to avoid damaging it. During the calibration, using a substitute load with the exact characteristics as the circuit load will preserve the specified CW-to-pulse level accuracy. The calibration should not be performed until the instrument has had sufficient time to warm up (usually 30 minutes). The calibration data remains valid as long as the ambient temperature remains stable. CW-to-pulse level accuracy degrades nominally by 0.07 dB/°C. For best accuracy, the calibration should be repeated whenever the ambient temperature changes.

The time the calibration routine takes to obtain the CW calibration values is equivalent to the normal frequency and power level switching times. In special pulse modulation mode, frequency and power level changes (without an attenuator range change) occur faster than during normal pulsed operation.

When running the following program, once the calibration is complete *and special pulse modulation mode is entered*, the following events will happen during pulsed frequency switching:

- The frequency ("FREQ ";Freqs(I);"MHZ") command is sent: This causes the signal generator to change frequency and the power level will drop to the minimum vernier level. The output power remains pulsed.
- The power level ("POW ";Powers(I);"DBM") command is sent: This causes the signal generator to adjust *only* the attenuator range. The vernier remains at its minimum level.
- The ("DIAG:IBUS 23,";Verniers(I)) command is sent: This adjusts the vernier level to its correct level. The signal generator is now pulsing at the correct frequency and power level.

---

### Note

The preceding commands must always be executed in the order presented for proper instrument operation. However, there are two cases when use of the frequency and/or power level commands can be minimized.

**Case 1** - If the signal generator will only be operating at one frequency, the frequency command only needs to be sent once.

**Case 2** - If the signal generator will only be operating at one attenuator range, the power level command only needs to be sent once.

---

```
10 OPTION BASE 1
```

```
  Sets the lowest element of all arrays to 1.
```

```
20 DIM Freqs(100),Powers(100),Verniers(100)
```

```
  Dimensions arrays.
```

```
30 Num_points=4
```

```
  Sets variable "Num_points" to 4 for this example. "Num_points" must be equal to the number of frequency/power level pairs in the DATA statement.
```

```
40 DATA 1000,0,1330,-4,1750,-25,2000,12
```

```
  The frequency/power level pairs to be used by this program. The first number and every other number is a frequency; the second number and every other number is a corresponding power level.
```

```
50 OUTPUT 719;"*RST"
```

```
  Presets the signal generator.
```

```
60 OUTPUT 719;"PULM:SOUR EXT"
```

```
  Selects external pulse mode for this example. Modify this statement for your desired pulse mode.
```

```
70 OUTPUT 719;"PULM:EXT:POL NORM"
```

```
  Selects normal pulse polarity for this example. Modify this statement for your desired pulse polarity.
```

```
80 OUTPUT 719;"PULM:STAT ON"
```

```
  Turns pulse modulation on.
```

```
90 INPUT "DISCONNECT AVERAGE POWER SENSITIVE DEVICES FROM THE RF OUTPUT,  
  THEN PRESS ENTER,"A.
```

```

100 !
110 FOR I=1 TO Num_points
120  READ Freqs(I),Powers(I)
    Reads frequency into the "I" position of array "Freqs" and power level into the "I" position of array "Powers."
130  OUTPUT 719;"FREQ ";Freqs(I);"MHZ;POW ";Powers(I);"DBM"
    Sets signal generator frequency and power level to the values in the arrays specified by "I."
140  OUTPUT 719;"DIAG:IBUS? 23"
    Queries the vernier DAC setting at the current frequency/power level.
150  ENTER 719;Verniers(I)
    Reads vernier DAC setting into the "I" position of array "Verniers."
160 NEXT I
170 !
180 OUTPUT 719;"DIAG:IBUS 73,16"
    Activates special pulse modulation mode.
190 INPUT "CONNECT DUT TO RF OUTPUT AND PRESS ENTER. ,"A
200 PRINT
210 !
220 FOR I=1 TO Num_points
230  OUTPUT 719;"FREQ ";Freqs(I);"MHZ;POW ";Powers(I);"DBM"
    Sets signal generator frequency and power level to the values in the arrays specified by "I."
240  OUTPUT 719;"DIAG:IBUS 23, ";Verniers(I)
    Sets vernier DAC to the value in the "I" position of array "Verniers."
250  PRINT "SIGNAL GENERATOR FREQUENCY IS CURRENTLY ";Freqs(I);" MHz, AND
    POWER LEVEL IS CURRENTLY ";Powers(I);" dBm."
260 IF I=Num_points THEN GOTO 300
270  INPUT "PRESS ENTER WHEN YOU ARE READY TO GO TO THE NEXT
    FREQUENCY/POWER LEVEL PAIR. ,"A
280 NEXT I
290 !
300 INPUT "PRESS ENTER TO EXIT SPECIAL PULSE MODULATION MODE. ,"A
310 !
320 OUTPUT 719;"*RST"
    Presets the signal generator.
330 PRINT
340 PRINT "NOTE: CYCLE SIGNAL GENERATOR POWER OFF AND ON TO
    TERMINATE SPECIAL PULSE MODULATION MODE."
350 PRINT
360 PRINT "END OF PROGRAM"
370 END

```

## Equivalent SCPI Command

```

POW:PROT:STAT ON|OFF;
    turns AVERAGE POWER LIMIT on and off

```

## See Also

AMPTD

[SOURce[1]:]POWer:PROTection:STATe Command



---

## RISETME MANAUTO

If you are using an HP 70341A with the HP 70340A, selecting the **Misc** menu and then **RISETME MANAUTO** allows you to choose manual (slow, medium, or fast) pulse risetime or enables the instrument to automatically select optimum pulse risetime for the selected carrier frequency.

---

The **INSTR PRESET** (**(I-P)**) state of this function is AUTO.

When you select RISE TIME MANUAL, three functions: RISE TIME FAST, RISE TIME MEDIUM, and RISE TIME SLOW are displayed. The risetime can be set to one of these three discrete values; risetime is not continuously variable.

---

**Note** RISE TIME MANUAL AUTOMATIC can be selected at any carrier frequency, but, at carrier frequencies above 1 GHz, pulse risetime is fixed at 10 ns.

---

**Note** When you manually set the risetime with this function, the falltime (pulse trailing edge) will be automatically set to the same value. There is no method of changing the falltime independently of the risetime.

---

## Applications

A series of low pass filters are used to reduce output harmonics when the HP 70340A output frequency is less than 1 GHz. The filter passbands can be narrow enough to induce pulse ringing if the pulse risetime is too fast.

The HP 70340A automatically selects a slower pulse risetime (when AUTO is selected) as the carrier frequency is decreased to minimize ringing and video feedthrough caused by the low pass filtering. The appropriate pulse risetime is automatically selected as follows:

| Output Frequency     | Pulse Risetime |
|----------------------|----------------|
| 10 MHz to 64 MHz     | 300 ns         |
| 64 MHz to 500 MHz    | 30 ns          |
| Greater than 500 MHz | 10 ns          |

In applications where a faster pulse risetime than that shown in the table is needed at output frequencies less than 1 GHz, you can manually choose a pulse risetime. The disadvantage of choosing a faster pulse risetime is degraded pulse performance.

## Equivalent SCPI Command

`PULS:TRAN:STAT ON|OFF` *selects either manual (ON) or automatic (OFF) risetime selection.*

`PULS:TRAN:LEAD SLOW|MED|FAST` *selects either a slow, medium, or fast pulse risetime.*

## See Also

`RISETME xxx`

`[SOURce[1]:]PULSe:TRANsition[:LEADing]`

`[SOURce[1]:]PULSe:TRANsition:STATe`

---

## RISETME xxx

If you are using an HP 70340A with the HP 70340A, selecting the **Misc** menu, `RISETME MANAUTO`, and then `RISETME xxx` (where xxx is FAST, MEDIUM, or SLOW) allows you to choose a pulse risetime at frequencies below 1 GHz.

---

## Notes

1. RISETIME FAST, MEDIUM, or SLOW can be selected at any carrier frequency, but, at carrier frequencies above 1 GHz, pulse risetime is fixed at 10 ns.
2. When you manually set the risetime with this function, the falltime (pulse trailing edge) will be automatically set to the same value. There is no method of changing the falltime independently of the risetime.

---

## Applications

A series of low pass filters are used to reduce output harmonics when the HP 70340A/41A output frequency is less than 1 GHz. The filter passbands can be narrow enough to induce pulse ringing if the pulse risetime is too fast.

The HP 70340A/41A automatically selects a slower pulse risetime (when AUTO is selected) as the carrier frequency is decreased to minimize ringing and video feedthrough caused by the low pass filtering. The appropriate pulse risetime is automatically selected as follows:

| Output Frequency     | Pulse Risetime |
|----------------------|----------------|
| 10 MHz to 64 MHz     | 300 ns         |
| 64 MHz to 500 MHz    | 30 ns          |
| Greater than 500 MHz | 10 ns          |

In applications where a faster pulse risetime than that shown in the table is needed at output frequencies less than 1 GHz, you can manually choose a pulse risetime. The disadvantage of choosing a faster pulse risetime is degraded pulse performance.

### Equivalent SCPI Command

PULS:TRAN:STAT ON|OFF      *selects either manual (ON) or automatic (OFF) risetime selection.*

PULS:TRAN:LEAD SLOW|MED|FAST      *selects either a slow, medium, or fast pulse risetime.*

### See Also

**RISETME MANAUTO**

[SOURce[1]:]PULSe:TRANsition[:LEADing]  
[SOURce[1]:]PULSe:TRANsition:STATe

---

## SELF TEST

Selecting the softkeys: **Misc** and **SELF TEST** initiate a signal generator self test which verifies the functionality of the signal generator and acts as a troubleshooting tool. This function requires no external equipment.

---

**Caution** Prior to running the instrument SELF TEST, disconnect any external connectors from the front panel of the signal generator. High power levels (+16 dBm) can occur during this routine.

---

When the SELF TEST routine is running, the display data entry box flashes messages like:

```
Running Self Test
presetting instrument
```

When the test completes without error, the display momentarily indicates:

```
self test complete
```

After the SELF TEST is complete, the signal generator returns to the **INSTR PRESET** (**I-P**) state.

If the test fails, the display indicates:

**x=y** where *x* and *y* are numbers which indicate an error condition.

If a particular self-test segment failure makes running subsequent self-test segments impossible, the self-tests will abort.

The self test creates some temporary error conditions that cause the signal generator's ERR Led and the display's "E" to turn on and remain on. This is characteristic of the self test and does not indicate an instrument or system failure. A *true* error condition is indicated only by the x=y display.

- 
- Notes**
1. It is recommended that the error queue be cleared before running the self-test.  
Error conditions are indicated by either the signal generator's red ERR Led or the display's "E."
  2. For information on reading the contents of the error queue, refer to "To Read the Contents of the Error Queue" in Chapter 2 of this book.
  3. Refer to the *HP 70340A Service Guide* for instructions on how to service SELF TEST failures.
-

## Equivalent SCPI Command

\*TST?

*performs a SELF TEST of the generator and returns a flag indicating error conditions*

## See Also

To Check the Error Queue

**INSTR PRESET** (**I-P**)

---

## service

The signal generator contains several service related functions under **Misc** main menu and the **service** submenu. The service menu functions are listed and briefly described in this chapter. However, since these functions are not intended for use during normal operation of the instrument, further reference to them is found in the *HP 70340A Service Guide* as they pertain to particular troubleshooting and repair procedures.

---

The service menu functions include: LO FREQUENCY, OFFSET FREQUENCY, HOLD POWER On/Off, CALIBRATE YIG OSCILLATOR, TRACE SLAVE, FACTORY CORRECTION On/Off, METER NODE, METER Automatic/Hold, HARDWARE CONTROL ADDRESS, and HARDWARE CONTROL VALAUE.

---

## SHOW INFO

Selecting **Misc** and **SHOW INFO** (SHOW INFORMATION) displays the following signal generator information: current signal CW FREQUENCY, current signal RF Output AMPLITUDE, the instrument serial number, and the firmware revision number.

### Equivalent SCPI Command

\*IDN?

### See Also

:SNUMber

---

## SHOW OPTION

Selecting **Misc**, **service**, and then **SHOW OPTION** displays instrument information which is useful for service. Reference to this function is found in the *HP 70340A Service Guide* under relevant troubleshooting and repair procedures.

### See Also

\*OPT?



---

## TRACE SLAVE

Selecting the softkeys **Misc**, **service**, and **TRACE SLAVE** reports all slave commands and data sent by the signal generator to its slaves. The *HP 70340A Service Guide* explains this function and where it is used in troubleshooting and repair procedures.

### See Also

SYSTem:PTHRough[:STRing] Command  
SYSTem:PTHRough:ADDRess Command

## Display Module Functions





---

This chapter contains the display module keys and functions which are useful for front panel operation of the Signal Generator. The entries are listed in alphabetical order.



Refer to “Performing Fundamental Operations” for tasks which relate to these functions. Refer to your display operating guide for more information about the display that you are using.

---

## ↑ and ↓ (Arrow Step) Keys

The display module's front panel  and  (arrow step) keys change the active function parameters in increments which depend upon the function. The  increases the parameter; the  decreases the parameter.

---

Pressing the  and  keys increases or decreases the active parameter by either the  (I-P) value of the current step size or the INCREMENT SET step size that you choose. The INCREMENT SET function is under the Modify Step menu.

---





**Note** A function parameter is active when the function appears in inverse video (highlighted). It remains active as long as its data appears in the data entry box near the bottom of the display.

---

If no function is currently active or the  or  function is active, pressing the  and  keys produces no effect.

Function parameters can also be changed using the numeric keypad or the Knob.

### Equivalent SCPI Command

There are no equivalent SCPI command for the  and  keys. However, the various SCPI commands that send numeric parameter data include “UP” and “DOWN” parameter options. Sending the “DOWN” parameter in place of the numeric parameter is effectively the same as pressing the  key. Sending the “UP” parameter in place of the numeric parameter is effectively the same as pressing the  key. For example, if you want to increase the output frequency by its current increment value, send the following SCPI command:

```
OUTPUT 719; "FREQ UP"  
increments the CW frequency by the current increment value
```

### See Also

**Knob**

**Numeric Keypad**







“To Enter Data with the Numeric Keypad”

---

## ⇐ (Back Space Arrow) Key

The ⇐ (Back Space Arrow) key on the display front panel has two purposes. First, it allows cancellation of part or all of a function parameter (by backspacing) during entry using the numeric keypad. Second, it lets you move from the menu that is currently displayed to the previous menu.

---

When you use the ⇐ key in conjunction with a function parameter *before the parameter entry is terminated*, the key lets you backspace to correct data entry errors.

When you use the ⇐ key in conjunction with the **DISPLAY** (**DSP**), **USER** (**USR**), and **MENU** (**MNU**) functions, the key allows you to return to a previous menu.

Each time you press the ⇐ key, the Signal Generator displays the menus that you have accessed from most to least recent.

### See Also



“To Use the Menus”

---

## 0 through 9, −, and . (Numeric Keypad)

The numeric keypad is used to enter a value for the current active function. The number is entered (recognized by the Signal Generator) when you press the appropriate units terminator softkey or the **ENTER** softkey.

---

The Knob or by using the   keys can also be used to change the active function parameter.

### See Also

Knob

  keys

“To Enter Data with the Numeric Keypad”

---

## DISPLAY (DSP) Key

Pressing the **DISPLAY** (**DSP**) key on the display module's front panel lets you access all of the system and display functions on the HP 70000 system.

---

**DISPLAY** controls addressing, communication, and configuration of the instrument modules within the MMS. Other functions that you can access with this key include: **PRINT**, **PLOT**, and **SELECT INSTR**. Refer to the mainframe operating manual for more details.

With this key and the **Address Map** menu, you can set the Signal Generator HP-IB address. Refer to the procedure, "To Set the HP-IB Address", in the Operating Section of this Manual.

Selecting the **DISPLAY** key and then the **REPORT ERRORS** function displays the error messages that are currently active, if any. Refer to the "Error Messages" chapter for information on reporting errors and steps to clear errors.

The **DISPLAY** key differs from the **MENU** (**MNU**) key in that the **MENU** key accesses the *Signal Generator* (or other instrument) functions, while **DISPLAY** accesses the HP 70000 *system and display* functions.

### See Also

The MMS Display Operating Manual  
"To Set the HP-IB Address"  
"To Read the Error Queue"

**MENU** Key

**USER** Key

---

## HOLD Key

When pressed, the front panel display **HOLD** key prevents further changes to the active function parameter. (This key is not available in the HP 70204A or 70205A Display.)

---

The **HOLD** key is used to prevent accidental changes to Signal Generator parameter settings.

When you press the **HOLD** key, the active function parameter is removed from the display data entry box, and the inverse video of the active function softkey is turned off.

To change a function parameter after you have pressed **HOLD**, press the function softkey (**CW FREQ**) to activate the function. Then, change the parameter using the numeric keypad, **↑** **↓** keys, or the Knob.

If you press the **HOLD** key twice, the main menu keys (on the left-hand side of the display) are blanked.

### See Also

**ENTRY HOLD**

**↑** **↓** (arrow step) keys

Knob

# INSTR PRESET (I-P) Key

The display module's **INSTR PRESET** (**I-P**) key sets the Signal Generator to a known (preset) state and menu display.

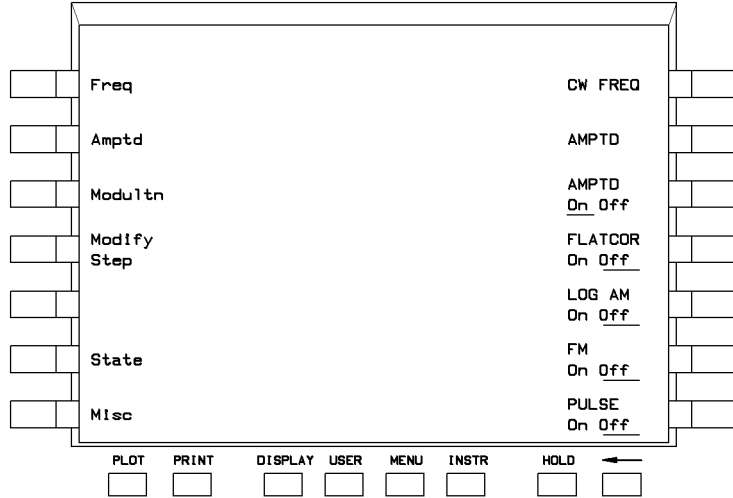

**Figure 6-1. Instrument Preset Full Screen Display**

The preset conditions are shown in the following table:



### Preset Conditions

| Parameter                             | Condition          | Parameter                                     | Condition   |
|---------------------------------------|--------------------|---|-------------|
| Amplitude                             | 0 dBm <sup>1</sup> | Flatness Correction Start Frequency           | 1 GHz       |
| Amplitude Increment                   | 1 dB               | Flatness Correction Start Frequency Increment | 1 GHz       |
| Amplitude On/Off                      | On                 | Flatness Correction Stop Frequency            | 20 GHz      |
| Attenuator Hold                       | Off                | Flatness Correction Stop Frequency Increment  | 1 GHz       |
| Average Power Limit                   | Off                | FM  | Off         |
| CW Frequency                          | 3 GHz              | FM Coupling                                   | AC          |
| CW Frequency Increment                | 100 MHz            | Frequency Multiplier                          | 1           |
| Entry Hold                            | Off                | Frequency Multiplier Increment                | 1           |
| Display                               | Not Cleared        | Gated Pulse Modulation (Option 1E2)           | Off         |
| Doublet Pulse Modulation (Option 1E2) | Off                | HP-IB Address Increment                       | 1           |
| Error Queue Front Panel               | Cleared            | Internal Leveling                             | On          |
| Error Queue HP-IB                     | Not Cleared        | Internal Pulse Modulation (Option 1E2)        | Off         |
| External Diode Leveling               | Off                | Log AM  | Off         |
| Ext. Power Meter- HP 70100A           | Selected           | PRF (Option 1E2)                              | 10 kHz      |
| Ext. Power Meter- HP 437B             | Not Selected       | PRF Increment (Option 1E2)                    | 100 Hz      |
| Ext. Power Meter- HP 438A             | Not Selected       | PRI (Option 1E2)                              | 100 $\mu$ s |
| Ext. Power Meter- SCPI                | Not Selected       | PRI Increment (Option 1E2)                    | 1 $\mu$ s   |
| Ext. Power Meter Leveling             | Off                | Pulse Delay (Option 1E2)                      | 1 $\mu$ s   |
| Ext. Power Meter Address              | 13                 | Pulse Delay Increment (Option 1E2)            | 25 ns       |
| Ext. Power Meter Reading              | 0 dBm              | Pulse Invert                                  | Off         |
| Ext. Power Meter Reading Increment    | 1 dB               | Pulse Risetime (HP 70341A)                    | AUTO        |
| External Pulse Modulation             | Off                | Pulse Width (Option 1E2)                      | 10 $\mu$ s  |
| Flatness Correction                   | Off                | Pulse Width Increment (Option 1E2)            | 100 ns      |
| Flatness Correction Points            | 51                 | service functions                             | Off         |
| Flatness Correction Points Increment  | 1                  | Triggered Pulse Mode (Option 1E2)             | Off         |
| Flatness Correction Register Select   | FDATA 1            |   |             |

1 When option 1E1 is installed, the preset value for power level is -90 dBm.

### Equivalent SCPI Commands

\*RST

SYST:PRES

*these commands are equivalent in the HP 70340A; either one presets the instrument*

## **See Also**

\*RST Command

SYSTem:PRESet Command

---

## Knob

The Knob is used to increase or decrease the parameter value of the active function. When you turn the Knob, the underscored digit in the display is increased or decreased by a factor of one.

---

Clockwise rotation of the Knob increases the underscored digit and counterclockwise rotation decreases it.

You can use the `KNOB <--` function to move the underscored decimal position of the active function to the left. Similarly, you can use the `KNOB -->` function to move the underscored decimal position to the right. These functions are in the `Modify Step` menu.

If `ENTRY HOLD` or `(HOLD)` is pressed, the underscore disappears from the parameter digit, and rotating the Knob has no effect on the instrument's parameters.

The `(↑)` `(↓)` keys and the numeric keypad can also be used to change function parameters.

### See Also

`KNOB <--`

`KNOB -->`

`INCR SET`

“To Modify Data with the Knob”

---

## LOCAL (LCL) Key

The **LOCAL** (**LCL**) key on the display front panel removes the Signal Generator from remote (HP-IB) control and reinstates front panel control.

---

When the Signal Generator switches from remote to local state, the **RMT LED** turns off.

If the Signal Generator is in the local lockout (LLO) state, pressing the **LCL** key does not remove the instrument from the remote state. In this case, the only way to return the Signal Generator to local operation is by setting the **REN** bus control line to false, sending the instrument the go-to-local (GTL) bus command, or cycling the instrument power.

### See Also

IEEE 488.1 Interface Capability

**RMT LED**

Status Register Commands

## MENU (MNU) Key

The front panel display **MENU** (**MNU**) key accesses the instrument functions which are available to the Signal Generator and other instrument modules in the MMS.

In the case of the Signal Generator, when the **MENU** key is pressed, the right-hand side of the screen displays the more commonly used instrument functions. The **MENU** display also appears when the instrument is preset or when the **USER** (**USR**) key is pressed.

The **MENU** (**MNU**) key is useful for exiting from the **DISPLAY** key menu in order to return to the instrument menu.

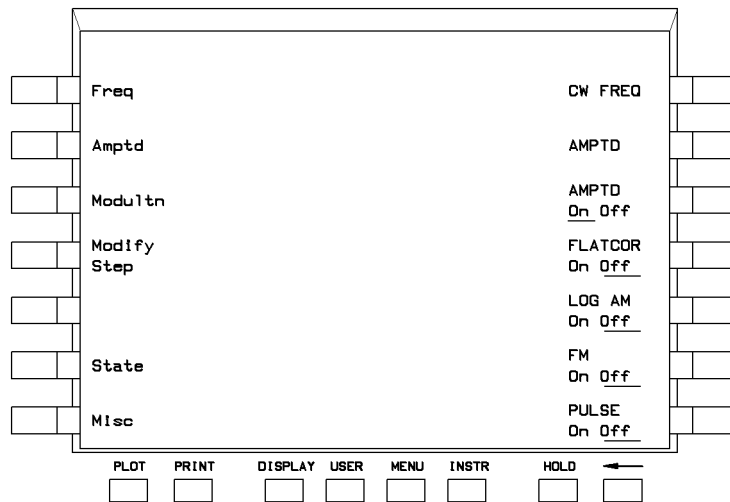

Figure 6-2. **MENU** Function Full Screen Display

The set of **MENU** (**MNU**) functions differs for each instrument.

---

## USER (USR) Key

In the case of the Signal Generator, when the **USER** (**USR**) key is pressed, the right-hand side of the screen displays the more commonly used functions.

---

The **USER** display also appears when the instrument is preset or when the **MENU** (**MNU**) is pressed.

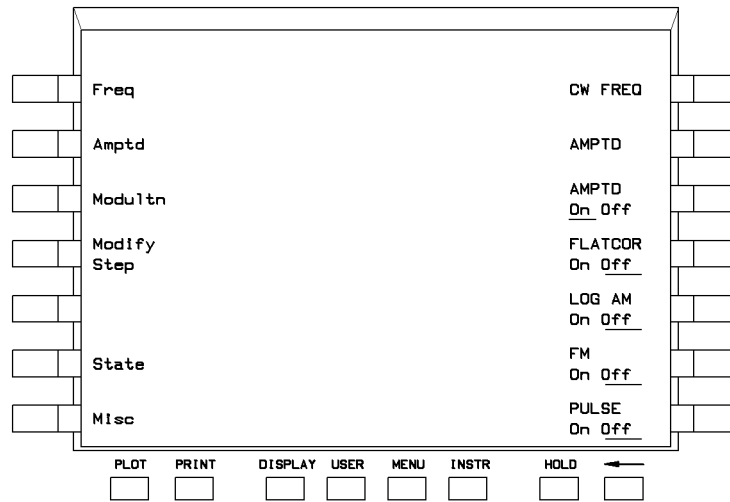

**Figure 6-3. **USER** Function Full Screen Display**

---

### Note

In the case of some other MMS modules, the **USER** key creates a custom menu containing only the functions that are used for a particular measurement. Refer to the display operating manual for more information about this key.

---



## Programming Commands

---

This chapter contains detailed information on all the programming commands used by the Signal Generator. The chapter is sub-divided into logical groupings of commands that are tabbed. For example, all programming commands pertaining to automatic level control are contained in one tabbed section. The individual commands are organized alphabetically within each section. The remainder of this introduction contains information that pertains to all programming commands. The programming command entries begin with the tab labeled “Automatic Level Control Commands” and end with the tab labeled “Status Register Commands.”



---

## Command Syntax

Following the heading for each programming command entry is a syntax statement showing the proper syntax for the command. An example syntax statement is shown below:

$$\left[ \text{SOURce} [ 1 ] : \right] \text{POWer} [ : \text{LEVel} ] [ : \text{IMMediate} ] [ : \text{AMPLitude} ] : \text{STEP} [ : \text{INCRement} ]$$
$$\left( \begin{array}{l} \textit{incr} \\ \text{MAXimum} \\ \text{MINimum} \\ \text{DEFault} \end{array} \right)$$

Syntax statements read from left to right and top to bottom. In the above example, the “:STEP” portion of the statement immediately follows the “[:AMPLitude]” portion of the statement with no separating space. A separating space is legal only between the command and its argument. In the above example, the portion following the “[:INCRement]” portion of the statement is the argument. Additional conventions used in the syntax statements are defined as follows:

- *italics* are used to symbolize a program code parameter or query response.
- ::= means “is defined as”.
- | (vertical bar) indicates a choice of one element from a list. For example, <A> | <B> indicates <A> or <B> but not both.
- ... (an ellipsis) is used to indicate that the preceding element may be repeated one or more times.
- [ ] (square brackets) indicate that the enclosed items are optional.
- { } (braces) indicate that one and only one of the enclosed elements must be selected.
- Upper-Case Lettering (**FREQUENCY**) indicates that the upper-case portion of the command is the minimum required for the command.
- Lower-Case Lettering (**fREQUENCY**) indicates that the lower-case portion of the command is optional; it can either be included with the upper-case portion of the command or omitted.

---

## Equivalent SCPI for the HP 8673 Series

The HP 70340A mnemonics and status system follow the ANSI/IEEE Std 488.2-1987 standard and the SCPI (Standard Command for Programmable Instruments) standard. The following table contains a listing of all the HP 8673 Series mnemonics and the equivalent SCPI or IEEE programming commands.

The HP 70340A requires at least one space between a mnemonic and its parameter. For example, the HP 8673 Series allows “FR2GZ”, but the HP 70340A requires a space, “FREQ 2GHZ”. In addition, the HP 70340A requires a semi-colon between each “program message unit” and a colon to return to the “root subsystem”. (a “program message unit” contains a mnemonic and any parameters). For example, the HP 8673 Series allows “A0FR3GZ”, but the HP 70340A requires a semi-colon and a colon, “AM:STAT OFF;;FREQ 2GHZ”.

**Table 7-1. HP 8673 Series SCPI/IEEE Equivalents**

| <b>HP 8673 Mnemonic</b> | <b>HP 8673 Description</b>                      | <b>SCPI/IEEE Mnemonic</b>   |
|-------------------------|---|---|
| AP                      | Set level (RANGE and VERNIER)                   | POW   |
| A0<br>AO<br>A1          | AM OFF  | AM:STAT OFF   |
| A2<br>A3                | AM 30%/volt<br>AM 100%/volt                     | The HP 70340A does not have linear AM. To turn logarithmic AM on, use "AM:STAT ON".   |
| B0<br>NM                | NORMAL - provides filtering of RF output signal | The HP 70340A does not have this mode.  |
| BS                      | Backspace                                       | The HP 70340A cannot perform a "backspace" from HP-IB.  |
| BY                      | BYPASS - removes filtering of RF output signal  | The HP 70340A does not have this mode.  |
| CF                      | Set center frequency for sweep mode             | The HP 70340A does not have sweep mode.   |
| CS                      | Clear status system - clears status byte        | The status system is very different in the HP 70340A. See the chapter "Programming Commands" for complete details; however, the HP 70340A's "*CLS" is approximately the same as "CS". |
| CT                      | Configure Trigger                               | The HP 70340A does not have an HP-IB trigger capability.  |
| CW                      | Change to CW mode                               | "AM:STAT OFF" and "FM:STAT OFF" and "PULM:STAT OFF"   |
| C1                      | ALC INTERNAL                                    | POW:ALC:SOUR INT  |
| C2                      | ALC DIODE                                       | POW:ALC:SOUR DIOD   |
| C3                      | ALC PWR MTR                                     | POW:ALC:SOUR PMET and<br>POW:ALC:PMET   |
| C4<br>SHC2              | ALC SYS Mode for millimeter heads               | POW:ALC:SOUR DIOD   |
| DB                      | dB  | DB  |
| DM                      | dBm   | DBM   |

**Table 7-1. HP 8673 Series SCPI/IEEE Equivalents (continued)**

| <b>HP 8673 Mnemonic</b>          | <b>HP 8673 Description</b>  | <b>SCPI/IEEE Mnemonic</b>  |
|----------------------------------|---|--|
| DF<br>FS                         | Set frequency span for sweep mode   | The HP 70340A does not have sweep mode.  |
| DN                               | Decrement the frequency   | FREQ DOWN  |
| DW                               | Set dwell time for sweep mode   | The HP 70340A does not have sweep mode.  |
| D0<br>D0<br>D1                   | FM DEVIATION OFF  | FM:STAT OFF  |
| D2<br>D3<br>D4<br>D5<br>D6<br>D7 | FM DEVIATION .03 MHz/V<br>FM DEVIATION .1 MHz/V<br>FM DEVIATION .3 MHz/V<br>FM DEVIATION 1 MHz/V<br>FM DEVIATION 3 MHz/V<br>FM DEVIATION 10 MHz/V | The 70340A does not allow setting the FM deviation. See the chapter “Specifications and Options” for FM specifications. To turn FM on, use “FM:STAT ON”. |
| FA                               | Set start sweep frequency   | The HP 70340A does not have sweep mode.  |
| FB                               | Set stop sweep frequency  | The HP 70340A does not have sweep mode.  |
| FI<br>FN<br>F1                   | Set frequency increment   | FREQ:STEP  |
| FO<br>FT<br>SHFB<br>SHDF         | Set positive or negative offset frequency when controlled by another HP 8673 in master/slave mode   | The HP 70340A does not support master/slave mode.  |
| FR                               | Set CW frequency  | FREQ   |
| GZ                               | GHz   | GHZ  |

**Table 7-1. HP 8673 Series SCPI/IEEE Equivalents (continued)**

| <b>HP 8673 Mnemonic</b> | <b>HP 8673 Description</b>   | <b>SCPI/IEEE Mnemonic</b>  |
|-------------------------|--|--|
| HZ                      | Hz   | HZ   |
| IF                      | Increment the frequency  | FREQ UP  |
| IP                      | Instrument Preset  | *RST   |
| KZ                      | kHz  | KHZ  |
| K0                      | AUTO PEAK OFF - turns off fine tuning adjustment of internal tracking filter | The HP 70340A does not have this mode.   |
| K1<br>K2                | AUTO PEAK ON - turns on fine tuning adjustment of internal tracking filter   | The HP 70340A does not have this mode.   |
| L1<br>OL                | Front Panel Learn Mode - returns front panel setting in a string             | *LRN?  |
| L2                      | Special Function Learn Mode  | The HP 70340A does not have this feature.<br>*LRN? returns the learn mode for all instrument settings. |
| MG                      | Message  | SYST:ERR?  |
| MS                      | milliseconds   | MS   |
| MU<br>MY<br>SHFA        | MULT - set frequency multiplier value  | FREQ:MULT  |
| MZ                      | MHz  | MHZ  |
| M0<br>MO<br>X0          | Turns sweep markers OFF  | The HP 70340A does not have sweep mode.  |
| M1<br>X1                | Turns sweep marker 1 ON and sets its value                                   | The HP 70340A does not have sweep mode.  |

**Table 7-1. HP 8673 Series SCPI/IEEE Equivalents (continued)**

| HP 8673 Mnemonic | HP 8673 Description                        | SCPI/IEEE Mnemonic   |
|------------------|--|--|
| M2<br>X2         | Turns sweep marker 2 ON and sets its value | The HP 70340A does not have sweep mode.  |
| M3<br>X3         | Turns sweep marker 3 ON and sets its value | The HP 70340A does not have sweep mode.  |
| M4<br>X4         | Turns sweep marker 4 ON and sets its value | The HP 70340A does not have sweep mode.  |
| M5<br>X5         | Turns sweep marker 5 ON and sets its value | The HP 70340A does not have sweep mode.  |
| N0<br>NO         | Disables frequency knob                    | The closest equivalent is to insure that the HP 70340A is in remote mode. The display's knob and keys are inactive if the HP 70340A is in remote. The HP BASIC command "REMOTE 719" will force the HP 70340A into remote. ENTRY HOLD is not available from HP-IB in the HP 70340A. |
| N1               | Enables frequency knob                     | The closest equivalent is to insure that the HP 70340A is in local mode. The display's knob and keys are active if the HP 70340A is in local. The HP BASIC command "LOCAL 7" will force the HP 70340A to stay in local. ENTRY HOLD is not available from HP-IB in the HP 70340A.   |
| [Mnemonic]OA     | Output Active Parameter                    | The HP 70340A allows adding a question mark (?) to any mnemonic and the value of the mnemonic parameter will be returned.  |
| OC               | Output Couple                              | The HP 70340A does not have sweep mode.  |
| OK               | Output Lock Frequency                      | The HP 70340A does not have this feature.  |
| OR               | Output Request Mask                        | The status system is very different in the HP 70340A. See the chapter "Programming Commands" for complete details; however, the HP 70340A's "*SRE?" is approximately the same as "OR".   |

**Table 7-1. HP 8673 Series SCPI/IEEE Equivalents (continued)**

| HP 8673 Mnemonic | HP 8673 Description                 | SCPI/IEEE Mnemonic   |
|------------------|-------------------------------------|--|
| OS               | Output Status                       | The status system is very different in the HP 70340A. See the chapter “Programming Commands” for complete details; however, the HP 70340A’s “*STB?” is approximately the same as “OS”. |
| PL               | Set power Level (RANGE and VERNIER) | POW  |
| P0<br>PO<br>P1   | PULSE OFF                           | PULS:STAT OFF  |
| P2               | PULSE NORM                          | PULS:EXT:POL NORM  |
| P3               | PULSE COMP                          | PULS:EXT:POL INV   |
| RA               | Set range                           | Range setting is not available directly in the HP 70340A, use “POW” instead. Or “POW” and “POW:ATT:AUTO” can be used to reach the desired vernier and range (attenuator setting).      |
| RC<br>RL         | Recall state                        | *RCL   |
| RCBS             | Alternate Instrument Preset         | The HP 70340A does not have this feature.  |
| RD               | RANGE Down 10 dB                    | Range setting is not available directly in the HP 70340A, use “POW” instead. To perform “power down 10 dB” in the HP 70340A, set “POW:STEP 10DB” and then send “POW DOWN”.             |
| R0<br>RO<br>RF0  | RF OFF                              | OUTP:STAT OFF  |
| R1<br>RF1        | RF ON                               | OUTP:STAT ON   |
| RM               | Set Request Mask                    | The status system is very different in the HP 70340A. See the chapter “Programming Commands” for complete details; however, the HP 70340A’s “*SRE” is approximately the same as “RM”.  |

**Table 7-1. HP 8673 Series SCPI/IEEE Equivalents (continued)**

| <b>HP 8673 Mnemonic</b> | <b>HP 8673 Description</b>                         | <b>SCPI/IEEE Mnemonic</b>  |
|-------------------------|--|--|
| RS                      | Reset Sweep  | The HP 70340A does not have sweep mode.  |
| RU                      | RANGE Up 10 dB                                     | Range setting is not available directly in the HP 70340A, use “POW” instead. To perform “power up 10 dB” in the HP 70340A, set “POW:STEP 10DB” and then send “POW UP”. |
| SD                      | Slave Down   | The HP 70340A does not support master/slave mode.  |
| SF<br>SP                | Set frequency step for sweep mode                  | The HP 70340A does not have sweep mode.  |
| SPOA                    | Output Sweep Steps and Step Size                   | The HP 70340A does not have sweep mode.  |
| SM                      | MANUAL Sweep                                       | The HP 70340A does not have sweep mode.  |
| SH                      | Shift  | The HP 70340A cannot perform a “shift” from HP-IB.   |
| SS                      | Sweep step frequency (suffix)                      | The HP 70340A does not have sweep mode.  |
| ST                      | Store state  | *SAV   |
| SU                      | Slave Up   | The HP 70340A does not support master/slave mode.  |
| SV                      | Service Function                                   | The HP 70340A has several service functions, each with their own mnemonic. Refer to the HP 70340A Service Manual for complete details.                                 |
| TI                      | Test Interface                                     | The HP 70340A does not have this feature.  |
| TR                      | Execute Trigger                                    | The HP 70340A does not have an HP-IB trigger capability.   |
| T1                      | Set front panel meter to read output level vernier | The HP 70340A does not have a level vernier meter.   |
| T2                      | Set front panel meter to measure AM depth          | The HP 70340A does not have an AM meter.   |
| T3                      | Set front panel meter to measure FM deviation      | The HP 70340A does not have an FM meter.   |
| UP                      | FREQ INCREMENT                                     | FREQ UP  |



**Table 7-1. HP 8673 Series SCPI/IEEE Equivalents (continued)**

| <b>HP 8673 Mnemonic</b> | <b>HP 8673 Description</b>             | <b>SCPI/IEEE Mnemonic</b>   |
|-------------------------|--|---|
| VE                      | Set vernier                            | Vernier setting is not available directly in the HP 70340A, use “POW” instead. Or “POW” and “POW:ATT:AUTO” can be used to reach the desired vernier and range (attenuator setting).   |
| W0<br>W0<br>W1          | SWEEP MODE OFF                         | The HP 70340A does not have sweep mode.   |
| W2                      | AUTO Sweep                             | The HP 70340A does not have sweep mode.   |
| W3                      | MANUAL Sweep                           | The HP 70340A does not have sweep mode.   |
| W4                      | SINGLE Sweep                           | The HP 70340A does not have sweep mode.   |
| W5                      | SINGLE Sweep: Arm Only                 | The HP 70340A does not have sweep mode.   |
| W6                      | SINGLE Sweep: Arm and Begin            | The HP 70340A does not have sweep mode.   |
| W7                      | Master Sweep                           | The HP 70340A does not have sweep mode.   |
| W8                      | Slave Sweep                            | The HP 70340A does not have sweep mode.   |
| XF                      | X FREQ suffix for frequency multiplier | The HP 70340A does not need a suffix for “FREQ:MULT”.   |
| Y0                      | FREQ display off                       | The HP 70340A turns off the whole display using “DISP:STAT OFF”.  |
| Y1                      | FREQ display on                        | The SCPI equivalent The HP 70340A turns on the whole display using “DISP:STAT ON”.  |
| @A                      | Start of Front Panel Learn Mode        | The HP 70340A’s learn mode begins with “SYST:SET”.  |
| @1                      | Set Request Mask                       | The status system is very different in the HP 70340A. See the chapter “Programming Commands” for complete details; however, the HP 70340A’s “*SRE” is approximately the same as “@1”. |
| @2                      | Deferred Execution Mode                | The HP 70340A is always in immediate execution mode.  |
| @3                      | Immediate Execution Mode               | The HP 70340A is always in immediate execution mode.  |
| @9                      | Start of Special Function Learn Mode   | The HP 70340A does not have this feature. See L2 above.   |

---

## [SOURce[1]:]POWer:ALC:PMETer

$$[\text{SOURce}[1]:]\text{POWer:ALC:PMETer}[:\text{LEVel}][:\text{AMPLitude}] \left\{ \begin{array}{l} p\text{meter} \\ \text{MAXimum} \\ \text{MINimum} \\ \text{UP} \\ \text{DOWN} \\ \text{DEFault} \end{array} \right.$$

The “[SOURce[1]:]POWer:ALC:PMETer” command is used to enter the initial reading of the external power meter to the Signal Generator for use during external power meter leveling.

The parameters are as follows:

|               |   |
|---------------|---|
| <i>pmeter</i> | Enters the initial reading of the external power meter to the Signal Generator. The allowable range for the parameter is $-100$ dBm to $+30$ dBm when option 1E1 is installed or $-15$ dBm to $+30$ dBm if option 1E1 is not installed. |
| MAXimum       | Sets the initial power meter reading to its maximum allowable value.  |
| MINimum       | Sets the initial power meter reading to its minimum allowable value.  |
| UP            | Increases the entered initial power meter reading by the current increment value.   |
| DOWN          | Decreases the entered initial power meter reading by the current increment value.   |
| DEFault       | Sets the initial power meter reading to its default (preset) value.   |

---

The power meter reading set with the “[SOURce[1]:]POWer:ALC:PMETer” command allows the Signal Generator to calculate the value of the voltage present at the power meter Recorder Output connector.

If an initial power meter reading is entered that is outside of its allowable range, an error message will be generated and the parameter will be set to either its maximum or minimum limit. The preset value for the parameter is 0 dBm.

### Query Syntax

$$[\text{SOURce}[1]:]\text{POWer:ALC:PMETer}[:\text{LEVel}][:\text{AMPLitude}]? \left[ \begin{array}{l} \text{MAXimum} \\ \text{MINimum} \\ \text{DEFault} \end{array} \right]$$

Returned format:

*pmeter*<NL>

Where:

- *pmeter* ::= The current entered initial power meter reading if no argument is specified.
- *pmeter* ::= The maximum initial power meter reading that can be set if the MAXimum argument is specified.
- *pmeter* ::= The minimum initial power meter reading that can be set if the MINimum argument is specified.

- *pmeter* ::= The default (preset) initial power meter reading if the DEFault argument is specified.

### See Also

[SOURce[1]:]POWer:ALC:PMETer:STEP  
[SOURce[1]:]POWer:ALC:SOURce  
UNIT:POWer|:VOLTage

---

## [SOURce[1]:]POWer:ALC:PMETer:STEP

$$[SOURce[1]:]POWer:ALC:PMETer[:LEVel]:STEP[:INCRement] \left\{ \begin{array}{l} incr \\ MAXimum \\ MINimum \\ DEFault \end{array} \right\}$$

The “[SOURce[1]:]POWer:ALC:PMETer:STEP” command selects the increment value for the entered initial power meter reading.

The parameters are as follows:

|             |   |
|-------------|---|
| <i>incr</i> | Sets the increment value for the initial power meter reading. The allowable range for the parameter is 0.01 dB to 130 dB when option 1E1 is installed or 0.01 dB to 45 dB if option 1E1 is not installed. |
| MAXimum     | Sets the increment value for the initial power meter reading to its maximum allowable value.  |
| MINimum     | Sets the increment value for the initial power meter reading to its minimum allowable value.  |
| DEFault     | Sets the increment value for the initial power meter reading to its default (preset) value.   |

---

When the “UP” or “DOWN” parameters are used with the “[SOURce[1]:]POWer:ALC:PMETer” command, the initial power meter reading will be increased or decreased by a step size set with the “[SOURce[1]:]POWer:ALC:PMETer:STEP” command.

Numeric power meter reading increment value entries have a resolution of 0.01 dB.

If an initial power meter reading increment value entry is made that is not within the allowable parameter range, an error message will be generated and it will be set to either its maximum or minimum limit. The preset value for the initial power meter reading increment value is 1 dB.

### Query Syntax

$$[SOURce[1]:]POWer:ALC:PMETer[:LEVel]:STEP[:INCRement]? \left[ \begin{array}{l} MAXimum \\ MINimum \\ DEFault \end{array} \right]$$

Returned format:

*incr*<NL>

Where:

- *incr* ::= The current power meter reading increment value if no argument is specified.
- *incr* ::= The maximum power meter reading increment value that can be set if the MAXimum argument is specified.
- *incr* ::= The minimum power meter reading increment value that can be set if the MINimum argument is specified.

- *incr* ::= The default (preset) power meter reading increment value if the DEFault argument is specified.

### See Also

[SOURce[1]:]POWer:ALC:PMETer  
UNIT:POWer]:VOLTage

---

## [SOURce[1]:]POWer:ALC:SOURce

$$[\text{SOURce}[1]:]\text{POWer:ALC:SOURce} \left\{ \begin{array}{l} \text{INTernal} \\ \text{DIODe} \\ \text{MMHead} \\ \text{PMETer} \end{array} \right\}$$

The “[SOURce[1]:]POWer:ALC:SOURce” command selects the type of leveling for output power automatic level control.

The parameters are as follows:

|          |   |
|----------|---|
| INTernal | Selects internal leveling.                |
| DIODe    | Selects external diode detector leveling. |
| MMHead   | Selects external diode detector leveling. |
| PMETer   | Selects external power meter leveling.    |

---

The `ALC DIODE` (diode detector leveling), `ALC PWR MTR` (power meter leveling), and `ALC INT` (internal leveling) entries in Chapter 5, “Signal Generator Menus and Functions”, provide detailed information on the type of leveling you select.

When the Signal Generator is set to the preset state, internal leveling is selected.

### Query Syntax

```
[SOURce[1]:]POWer:ALC:SOURce?
```

Returned format:

```
source<NL>
```

Where:

- *source* ::= “INT” if internal leveling is currently selected.
- *source* ::= “DIOD” if external diode detector leveling is currently selected.
- *source* ::= “PMET” if external power meter leveling is currently selected.

### See Also

`ALC DIODE`

`ALC PWR MTR`

`ALC INT`

[SOURce[1]:]POWer:ALC:PMETer

[SOURce[1]:]POWer[:LEVel]

To Use External Diode Detector Leveling

To Use External Power Meter Leveling

---

## [SOURce[1]:]FREQUency[:CW]:FIXed]

$$[\text{SOURce}[1]:]\text{FREQUency}[:\text{CW}]:\text{FIXed} \left\{ \begin{array}{l} \text{freq} \\ \text{MAXimum} \\ \text{MINimum} \\ \text{UP} \\ \text{DOWN} \\ \text{DEFault} \end{array} \right\}$$

The “[SOURce[1]:]FREQUency[:CW]:FIXed]” command sets the output frequency of the Signal Generator.

The parameters are as follows:

|             |  |
|-------------|--|
| <i>freq</i> | Sets the Signal Generator output frequency. The allowable range for the parameter is 1.0 GHz to 20 GHz for the HP 70340A . |
| MAXimum     | Sets the Signal Generator output frequency to the maximum allowable value.   |
| MINimum     | Sets the Signal Generator output frequency to the minimum allowable value.   |
| UP          | Increases the Signal Generator output frequency by the current output frequency increment value.                           |
| DOWN        | Decreases the Signal Generator output frequency by the current output frequency increment value.                           |
| DEFault     | Sets the Signal Generator output frequency to its default (preset) value.  |

---

The frequency entered is the CW frequency if no modulation is chosen, or the carrier frequency of any modulation type that is chosen. The preset value for the frequency parameter is 3 GHz.

The allowable range for the frequency parameter is 1.0 GHz to 20 GHz for the HP 70340A. If a frequency parameter entry is made that is outside the allowable range, an error message will be generated and the actual frequency will be set to either its upper or lower limit. Frequency resolution is 1 kHz. If option 1E8 is installed, frequency resolution is 1 Hz.

### Query Syntax

$$[\text{SOURce}[1]:]\text{FREQUency}[:\text{CW}]:\text{FIXed} ? \left[ \begin{array}{l} \text{MAXimum} \\ \text{MINimum} \\ \text{DEFault} \end{array} \right]$$

Returned format:

*freq*<NL>

Where:

- *freq* ::= The current output frequency if no argument is specified.
- *freq* ::= The maximum output frequency that can be set if the MAXimum argument is specified.
- *freq* ::= The minimum output frequency that can be set if the MINimum argument is specified.

- *freq* ::= The default (preset) output frequency if the DEFault argument is specified.

### See Also

[SOURce[1]:]FREQuency[:CW|:FIXed]:STEP

[SOURce[1]:]FREQuency:MULTiplier

UNIT:FREQuency



---

## [SOURce[1]:]FREQUency[:CW|:FIXed]:STEP

$$[SOURce[1]:]FREQUency[:CW|:FIXed]:STEP[:INCRement] \left\{ \begin{array}{l} incr \\ MAXimum \\ MINimum \\ DEFault \end{array} \right\}$$

The “[SOURce[1]:]FREQUency[:CW|:FIXed]:STEP” command selects the increment value for the Signal Generator output frequency.

The parameters are as follows:

|             |   |
|-------------|---|
| <i>incr</i> | Sets the increment value for output frequency. The allowable range for the parameter is 1 kHz to 19 GHz if the CW frequency range is 1 GHz to 20 GHz or 250 Hz to 19.99 GHz if the CW frequency range is 0.01 GHz to 1 GHz. |
| MAXimum     | Sets the output frequency increment value to its maximum allowable value.   |
| MINimum     | Sets the output frequency increment value to its minimum allowable value.   |
| DEFault     | Sets the output frequency increment value to its default (preset) value.  |

---

When the “UP” or “DOWN” parameters are used with the “[SOURce[1]:]FREQUency[:CW|:FIXed]” command, the output frequency will be increased or decreased by the step size set with the “[SOURce[1]:]FREQUency[:CW|:FIXed]:STEP” command.

If an output frequency increment value entry is made that is not within the allowable parameter range, an error message will be generated and it will be set to either its maximum or minimum limit. The preset value for the output frequency increment value is 100 MHz.

---

**Note** The HP 70340A Signal Generator will accept an increment value down to 250 Hz resolution when the output frequency is between 1 GHz and 20 GHz, however, when the “UP” or “DOWN” parameters are used with the “[SOURce[1]:]FREQUency[:CW|:FIXed]” command, the increment value will be rounded to the nearest 1 kHz before affecting frequency output.

---

### Query Syntax

$$[SOURce[1]:]FREQUency[:CW|:FIXed]:STEP[:INCRement]? \left[ \begin{array}{l} MAXimum \\ MINimum \\ DEFault \end{array} \right]$$

Returned format:

*incr*<NL>

Where:

- *incr* ::= The current output frequency increment value if no argument is specified.
- *incr* ::= The maximum output frequency increment value that can be set if the MAXimum argument is specified.
- *incr* ::= The minimum output frequency increment value that can be set if the MINimum argument is specified.

- *incr* ::= The default (preset) output frequency increment value if the DEFault argument is specified.

### See Also

[SOURce[1]:]FREQuency[:CW]:FIXed]  
UNIT:FREQuency

---

## [SOURce[1]:]FREQUency:MULTIplier

[SOURce[1]:]FREQUency:MULTIplier  $\left\{ \begin{array}{l} mult \\ MAXimum \\ MINimum \\ UP \\ DOWN \\ DEFault \end{array} \right\}$

The “[SOURce[1]:]FREQUency:MULTIplier” command sets the multiplier value so that the Signal Generator display will indicate the frequency at the output of an external frequency multiplier.

The parameters are as follows:

|             |   |
|-------------|---|
| <i>mult</i> | Sets the multiplier value. The allowable range for the parameter is 1 to 100.   |
| MAXimum     | Sets the multiplier value to its maximum allowable value.                       |
| MINimum     | Sets the multiplier value to its minimum allowable value.                       |
| UP          | Increases the multiplier value by the current multiplier value increment value. |
| DOWN        | Decreases the multiplier value by the current multiplier value increment value. |
| DEFault     | Sets the multiplier value to its default (preset) value.                        |

---

If a frequency multiplier value is entered that is out of range, an error message will be generated and the parameter will be set to either its maximum or minimum limit. The preset value for the multiplier value is 1.

Entering a frequency multiplier value is useful when an output frequency will be generated with external multiplier equipment. *Setting the multiplier value scales the display so that the frequency shown on the display will be the frequency at the output of the external frequency multiplier, not at the Signal Generator **RF OUTPUT** connector.*

When the multiplier function is being used and you enter a frequency parameter value with the “[SOURce[1]:]FREQUency[:CW|:FIXed]” command, be aware that the entered frequency divided by the multiplier value (the frequency before multiplication) has a minimum resolution of 1 kHz. As an example, assume a multiplier value of two has been entered and you attempt to enter a frequency of 4,000,001,000 Hz. The actual frequency that the Signal Generator would need to generate would be 2,000,000,500 Hz. The Signal Generator, however, can not output this signal because the standard specified resolution is 1 kHz. In this case, the actual output frequency would be rounded to 2,000,001,000 Hz and the display would show 4,000,002,000 Hz.

## Query Syntax

[SOURCE[1]:]FREQUENCY:MULTIPLIER? 

|         |
|---------|
| MAXimum |
| MINimum |
| DEFault |

Returned format:

*mult*<NL>

Where:

- *mult* ::= The current multiplier value if no argument is specified.
- *mult* ::= The maximum multiplier value that can be set if the MAXimum argument is specified.
- *mult* ::= The minimum multiplier value that can be set if the MINimum argument is specified.
- *mult* ::= The default (preset) multiplier value if the DEFault argument is specified.

## See Also

[SOURCE[1]:]FREQUENCY[:CW]:FIXED  
[SOURCE[1]:]FREQUENCY:MULTIPLIER:STEP  
To Generate Millimeter Signals

---

## [SOURce[1]:]FREQuency:MUlTiplier:STEP

$$[SOURce[1]:]FREQuency:MUlTiplier:STEP[:INCRement] \left\{ \begin{array}{l} incr \\ MAXimum \\ MINimum \\ DEFault \end{array} \right\}$$

The “[SOURce[1]:]FREQuency:MUlTiplier:STEP” command selects the increment value for the external frequency multiplier value.

The parameters are as follows:

|             |  |
|-------------|--|
| <i>incr</i> | Sets the multiplier increment value. The allowable range for the parameter is 1 to 99. |
| MAXimum     | Sets the multiplier increment value to its maximum allowable value.                    |
| MINimum     | Sets the multiplier increment value to its minimum allowable value.                    |
| DEFault     | Sets the multiplier increment value to its default (preset) value.                     |

---

When the “UP” or “DOWN” parameters are used with the “[SOURce[1]:]FREQuency:MUlTiplier” command, the multiplier value will be increased or decreased by a step size set with the “[SOURce[1]:]FREQuency:MUlTiplier:STEP” command.

If a multiplier increment value entry is made that is not within its allowable parameter range, an error message will be generated and it will be set to either its maximum or minimum limit. The preset value for the multiplier increment value is 1.

### Query Syntax

$$[SOURce[1]:]FREQuency:MUlTiplier:STEP[:INCRement]? \left[ \begin{array}{l} MAXimum \\ MINimum \\ DEFault \end{array} \right]$$

Returned format:

*incr*<NL>

Where:

- *incr* ::= The current multiplier increment value if no argument is specified.
- *incr* ::= The maximum multiplier increment value that can be set if the MAXimum argument is specified.
- *incr* ::= The minimum multiplier increment value that can be set if the MINimum argument is specified.
- *incr* ::= The default (preset) multiplier increment value if the DEFault argument is specified.

### See Also

[SOURce[1]:]FREQuency:MUlTiplier

---

## **\*IDN? (Identification Query)**

`*IDN?`

The “\*IDN?” query returns a string that contains the the instrument model number, serial number, and firmware revision number.

---

When the “\*IDN?” query is received by the instrument, it returns the following string:

```
HEWLETT-PACKARD,70340A,ser no,REVXX.Y
```

Where *ser no* is the instrument serial number, and *XX.Y* is the firmware revision number.

Note that “\*IDN?” should always be the last query in a command line.

---

## \*OPT? (Option Identification Query)

\*OPT?

The “\*OPT?” query returns a list of the Signal Generator option numbers.

---

In response to the “\*OPT?” query, the Signal Generator will return a string in the following form:

option#1,option#2,option#3,... .option#n,

The possible Signal Generator options returned with this command are shown in the following table. If the Signal Generator contains none of the options stated in the following table, “0” will be returned.

**Signal Generator Options**

| <b>Option Number</b> | <b>Description</b>             |
|----------------------|--------------------------------|
| 1E1                  | Add step attenuator.           |
| 1E5                  | Add high stability timebase.   |
| 1E8                  | Add 1 Hz Frequency Resolution. |
| 1E9                  | 3.5 mm RF Output connector.    |
| CIIL                 | Add CIIL Language Support.     |

---

## OUTPut:IMPedance?

OUTPut:IMPedance?  $\left[ \begin{array}{l} \text{MAXimum} \\ \text{MINimum} \\ \text{DEFault} \end{array} \right]$

The “OUTPut:IMPedance?” query returns the output impedance of the Signal Generator **RF OUTPUT** connector.

---

**Note** The Signal Generator output impedance is not selectable; therefore, “+5.000000000000E+001” will always be returned in response to this query. This query is provided for SCPI compatibility.

---

When the “OUTPut:IMPedance?” query is sent, the following is returned:

*imp*<NL>

Where:

- *imp* ::= The current output impedance if no argument is specified. In this version of the Signal Generator, “+5.000000000000E+001” will always be returned.
- *imp* ::= The maximum output impedance that can be obtained when the MAXimum argument is specified. In this version of the Signal Generator, “+5.000000000000E+001” will always be returned.
- *imp* ::= The minimum output impedance that can be obtained when the MINimum argument is specified. In this version of the Signal Generator, “+5.000000000000E+001” will always be returned.
- *imp* ::= The default (preset) output impedance if the DEFault argument is specified. In this version of the Signal Generator, “+5.000000000000E+001” will always be returned.



---

## [SOURce[1]:]ROSCillator:SOURce?

[SOURce[1]:]ROSCillator:SOURce?

The “[SOURce[1]:]ROSCillator:SOURce?” query returns the source of the Signal Generator timebase reference.

---

When the “[SOURce[1]:]ROSCillator:SOURce?” query is sent, the following is returned:

*Sour*<NL>

Where:

- *Sour* ::= “INT” if the Signal Generator internal timebase reference is currently in use.
- *Sour* ::= “EXT” if an external timebase reference is currently in use.

### See Also

Connectors

---

## SYSTem:ERRor?

SYSTem:ERRor?

The “SYSTem:ERRor?” query returns the the oldest uncleared error number and error description from the Signal Generator HP-IB error queue.

---

When an error is read, it is cleared as long as the error condition no longer exists.

When the “SYSTem:ERRor?” query is sent, only the oldest unread error in the HP-IB error queue will be returned.

---

**Note** The table of error messages in Chapter 8, “Error Messages”, is organized in ascending detailed error number order. Use the detailed error number enclosed in parentheses when looking up the error condition.

---

The HP-IB error queue can contain a maximum of 16 error messages. If the HP-IB error queue overflows, the 16th error in the queue will be replaced with -350, “Queue overflow”. If the queue is empty, the message 0, “No error” will be returned.

---

**Note** The HP-IB error queue returns the oldest error message when queried. Preset has no effect on the HP-IB error queue; it is only cleared at power up, by sending the “\*CLS” command, or by reading its entire contents.

---

### See Also

\*CLS  
Error Messages

---

## SYSTem:VERSion?

SYSTem:VERSion?

The “SYSTem:VERSion?” query returns the SCPI (Standard Commands for Programmable Instruments) version number that the Signal Generator supports.

---

When the “SYSTem:VERSion?” query is sent, the following is returned:

*vers*<NL>

Where:

- *vers* ::= The SCPI version number currently supported by the Signal Generator.

---

## \*TST? (Self-Test Query)

\*TST?

The “\*TST?” query causes the instrument to perform a self-test.

---

No external equipment is required to run the instrument self-test. Prior to running the self-test, disconnect any equipment that is connected to the **RF OUTPUT** as the Signal Generator might generate high output power during the self-test. When the self-test is complete, the Signal Generator is set to the preset state.

The result of the instrument self-test will be placed in the output queue. A 0 indicates that the test passed and a non-zero value indicates that one or more of the self-test segments failed.

---

**Note** Refer to the *HP 70340A Service Guide* (HP part number 70340-90007) for a listing of the test segments that are run during the self-test and their bit weights.

---

---

## \*LRN? (Learn Device Setup Query)

\*LRN?

The “\*LRN?” query returns an HP-IB command that contains the current state of the Signal Generator.

---

The information returned in response to the “\*LRN?” query can be stored in a string variable in computer memory. When the string is issued to the Signal Generator, the instrument settings are changed back to the state when the “\*LRN?” query was executed.

The instrument settings captured by executing the “\*LRN?” query include everything that is saved by executing the “\*SAV” command. This includes user settings, including any active user special functions (and everything else affected by sending the “\*RST” command).

---

**Note**            The instrument will not return the contents of the save/recall registers in response to executing the “\*LRN?” query.

---

The \*LRN? response may have any ASCII character including <NL>, so you must use the USING “-K” option of the “ENTER” BASIC command to cause the array variable to fill up until a <NL><EOI> sequence occurs.

## **See Also**

- \*RCL
- \*RST
- \*SAV

---

## MEMory:RAM:INITialize

MEMory:RAM:INITialize [ :ALL ]

The “MEMory:RAM:INITialize” command clears all of the Signal Generator Random Access Memory (RAM).

---

When the “MEMory:RAM:INITialize” command is sent, all user settings are set to the preset state, save/recall registers are erased, and level correction data is cleared. Sending the “MEMory:RAM:INITialize” command does not clear factory calibration data stored in the instrument EEPROM. This command is useful when removing the Signal Generator from a secure area since all of the setup history of the Signal Generator will be erased.

### See Also

ERASE MEMORY  
\*RST  
SYSTem:PRESet

---

## **\*RCL (Recall Command)**

*\*RCL register*

The “\*RCL” command allows you to recall a previously stored instrument state from one of ten register locations.

The parameter is as follows:

*register*            The number of the register where the desired instrument state has been stored. The number must be an integer from 0 to 9.

---

If you attempt to recall an instrument state from a register location to which an instrument state had not been previously saved, the preset state is recalled.

Instrument state registers are located in battery-backed RAM.

### **See Also**

\*SAV



## \*RST (Reset Command)

\*RST

The “\*RST” command sets the Signal Generator to the preset state.

The “\*RST” (preset) conditions are shown in the following table:

**PRESET Conditions**

| Parameter                                      | Condition     | Parameter                                   | Condition          |
|--|---------------|---|--------------------|
| Average Power Inhibit                          | Not Inhibited | Internal Pulse Modulation                   | Off                |
| CORR:CSET:SEL (Table Select for Correction)    | FDAT1         | Last Special Function Active                | 1                  |
| CORR:CSET:STAT (Flatness Correction State)     | OFF           | Level Correction State                      | Off                |
| CORR:STAT command (All User Corrections State) | OFF           | Level Correction Number of Points Increment | 1                  |
| Display  | On            | Level Correction Start Frequency Increment  | 100 MHz            |
| Doublet Pulse Modulation                       | Off           | Level Correction Stop Frequency Increment   | 100 MHz            |
| Error Queue                                    | Cleared       | Lock Step Attenuator                        | Off                |
| External Diode Leveling                        | Off           | Log AM                                      | Off                |
| Ext. Power Meter Leveling                      | Off           | Macros                                      | Not Enabled        |
| External Pulse Modulation                      | Off           | Power Level                                 | 0 dBm <sup>1</sup> |
| FM   | Off           | Power Level Increment                       | 1 dB               |
| FM Coupling                                    | AC            | PRF   | 1 kHz              |
| FM Sensitivity                                 | 5 MHz/V       | PRF Increment                               | 1 kHz              |
| Frequency                                      | 3 GHz         | PRI   | 1 ms               |
| Frequency Increment                            | 100 MHz       | PRI Increment                               | 1 ms               |
| Frequency Multiplier                           | 1             | Pulse Delay                                 | 0 ns               |
| Frequency Multiplier Increment                 | 1             | Pulse Delay Increment                       | 100 ns             |
| Front Panel Error Queue                        | Cleared       | Pulse Invert                                | Off                |
| Gated Pulse Modulation                         | Off           | Pulse Risettime                             | AUTO <sup>2</sup>  |
| HP-IB Address Increment                        | 1             | Pulse Width                                 | 10 $\mu$ s         |
| Initial Power Meter Level                      | 0 dBm         | Pulse Width Increment                       | 1 $\mu$ s          |
| Initial Power Meter Level Increment            | 1 dB          | RF On/Off                                   | On                 |
| Internal Leveling                              | On            | Special Functions                           | Off                |
|  |               | Triggered Pulse Mode                        | Off                |

1 When option 1E1 is installed, the preset value for power level is -90 dBm.

2 HP 70340A only.

## See Also

SYSTem:PRESet

---

## **\*SAV (Save Command)**

*\*SAV register*

The “\*SAV” command allows you to save the instrument state in one of ten register locations.

The parameter is as follows:

*register*            The number of the register where the instrument state is to be stored. The number must be an integer from 0 to 9.

---

All user settings that are affected by preset will be saved. Level correction tables will not be saved.

Saving the instrument state to a given register location will write over any instrument state previously stored in that register.

Instrument state registers are located in battery-backed RAM.

### **See Also**

\*RCL

## SYSTem:PRESet

SYSTem:PRESet

The “SYSTem:PRESet” command sets the Signal Generator to the preset state.

The “SYSTem:PRESet” (preset) conditions are shown in the following table:

**PRESET Conditions**

| Parameter                                      | Condition     | Parameter                                   | Condition          |
|--|---------------|---|--------------------|
| Average Power Inhibit                          | Not Inhibited | Internal Pulse Modulation                   | Off                |
| CORR:CSET:SEL (Table Select for Correction)    | FDAT1         | Last Special Function Active                | 1                  |
| CORR:CSET:STAT (Flatness Correction State)     | Off           | Level Correction State                      | Off                |
| CORR:STAT command (All User Corrections State) | Off           | Level Correction Number of Points Increment | 1                  |
| Display  | On            | Level Correction Start Frequency Increment  | 100 MHz            |
| Doublet Pulse Modulation                       | Off           | Level Correction Stop Frequency Increment   | 100 MHz            |
| Error Queue                                    | Cleared       | Lock Step Attenuator                        | Off                |
| External Diode Leveling                        | Off           | Log AM                                      | Off                |
| Ext. Power Meter Leveling                      | Off           | Macros                                      | Not Enabled        |
| External Pulse Modulation                      | Off           | Power Level                                 | 0 dBm <sup>1</sup> |
| FM   | Off           | Power Level Increment                       | 1 dB               |
| FM Coupling                                    | AC            | PRF   | 1 kHz              |
| FM Sensitivity                                 | 5 MHz/V       | PRF Increment                               | 1 kHz              |
| Frequency                                      | 3 GHz         | PRI   | 1 ms               |
| Frequency Increment                            | 100 MHz       | PRI Increment                               | 1 ms               |
| Frequency Multiplier                           | 1             | Pulse Delay                                 | 0 ns               |
| Frequency Multiplier Increment                 | 1             | Pulse Delay Increment                       | 100 ns             |
| Front Panel Error Queue                        | Cleared       | Pulse Invert                                | Off                |
| Gated Pulse Modulation                         | Off           | Pulse Risettime                             | AUTO <sup>2</sup>  |
| HP-IB Address Increment                        | 1             | Pulse Width                                 | 10 $\mu$ s         |
| Initial Power Meter Level                      | 0 dBm         | Pulse Width Increment                       | 1 $\mu$ s          |
| Initial Power Meter Level Increment            | 1 dB          | RF On/Off                                   | On                 |
| Internal Leveling                              | On            | Special Functions                           | Off                |
|  |               | Triggered Pulse Mode                        | Off                |

1 When option 1E1 is installed, the preset value for power level is -90 dBm.

2 HP 70340A only.

### See Also

\*RST



---

## MEMory:TABLE:FREQuency

$$\text{MEMory:TABLE:FREQuency} \left\{ \begin{array}{l} \text{freq, freq, freq, ... freq} \\ \text{MAXimum} \\ \text{MINimum} \end{array} \right\}$$

The “MEMory:TABLE:FREQuency” command is used to load the frequency points into the level correct table selected using the “MEMory:TABLE:SElect” command.

The parameter is as follows:

- freq*            The frequency points that make up the frequency portion of a level correct table. Each “freq” parameter can be a numeric value or one of 2 optional parameters. These are explained further below:
- If the “freq” parameter is a numeric value, the parameter range is 1 GHz to 20 GHz for the HP 70340A and 0.01 GHz to 20 GHz for the HP 70340A.
  - If the “freq” parameter is replaced with **MAXimum**, that frequency element of the level correct table will be set to its maximum allowable value.
  - If the “freq” parameter is replaced with **MINimum**, that frequency element of the level correct table will be set to its minimum allowable value.

---

The string of frequency points must be separated by commas and can be from 2 to 401 frequency points long. If the string of frequency points is not in ascending order, an error message is generated and the string of frequency points is rejected (the previous frequency points in the table are unaffected).

If a frequency point entry is made that is not within its allowable range, an error message will be generated and the parameter will be set to either its upper or lower limit. The resolution for all frequency points is 1 kHz. All tables are preset at the factory with no frequency points loaded. Once loaded with frequency points, pressing the **INSTR PRESET** (**I-P**) key has no effect on frequency points loaded into the tables.

---

**Note**            The total number of frequency points loaded using this command must be identical to the number of correction factors loaded with the “MEMory:TABLE:LOSS[:MAGNitude]” command. If they aren’t identical, an error message will be generated when you try to use the table to correct power at the **RF OUTPUT** connector.

---

### Query Syntax

$$\text{MEMory:TABLE:FREQuency?} \left[ \begin{array}{l} \text{MAXimum} \\ \text{MINimum} \end{array} \right]$$

Returned format:

*fdata*<NL>

Where:

- *fdata* ::= The string of frequency points (separated by commas) that are currently loaded in the table selected with the “MEMory:TABLE:SElect” command if no argument is used.

- *fdata* ::= The maximum allowable frequency value for any frequency point if the MAXimum argument is specified.
- *fdata* ::= The minimum allowable frequency value for any frequency point if the MINimum argument is specified.

## See Also

MEMory:TABLE:FREQuency:POINts?

MEMory:TABLE:LOSS[:MAGNitude]

MEMory:TABLE:LOSS[:MAGNitude]:POINts?

MEMory:TABLE:SElect

To Use the Level Correct Routine

---

## MEMory:TABLE:FREQuency:POINts?

MEMory:TABLE:FREQuency:POINts?  $\left[ \begin{array}{l} \text{MAXimum} \\ \text{MINimum} \end{array} \right]$

The “MEMory:TABLE:FREQuency:POINts?” query returns the number of frequency points loaded into the level correct table currently selected using the “MEMory:TABLE:SElect” command.

---

When the “MEMory:TABLE:FREQuency:POINts?” query is sent, the following is returned:

*poIn*<NL>

Where:

- *poIn* ::= The number of frequency points currently loaded into the selected level correct table if no argument is specified.
- *poIn* ::= The maximum number of frequency points that can be loaded into a table when the MAXimum argument is specified.
- *poIn* ::= The minimum number of frequency points that can be loaded into a table when the MINimum argument is specified.

### See Also

MEMory:TABLE:FREQuency  
MEMory:TABLE:SElect  
To Use the Level Correct Routine



---

## MEMory:TABLE:LOSS[:MAGNitude]

$$\text{MEMory:TABLE:LOSS[:MAGNitude]} \left\{ \begin{array}{l} cf, cf, cf, \dots cf \\ \text{MAXimum} \\ \text{MINimum} \end{array} \right\}$$

The “MEMory:TABLE:LOSS[:MAGNitude]” command is used to load the correction factors into the level correct table selected using the “MEMory:TABLE:SElect” command.

The parameter is as follows:

- cf*                    The correction factors that make up the correction factor portion of a level correct table. Each “cf” parameter can be a numeric value or one of 2 optional parameters. These are explained further below:
- If the “cf” parameter is a numeric value, the parameter range is –40 dB to +40 dB.
  - If the “cf” parameter is replaced with **MAXimum**, that correction factor element of the level correct table will be set to its maximum allowable value.
  - If the “cf” parameter is replaced with **MINimum**, that correction factor element of the level correct table will be set to its minimum allowable value.

---

The string of correction factors must be separated by commas and can be from 2 to 401 correction factors long.

If a correction factor entry is made that is not within its allowable range, an error message will be generated and the parameter will be set to either its upper or lower limit. The resolution for correction factors is 0.01 dB. All tables are preset at the factory with no correction factors loaded. Once loaded with correction factors, pressing the **INSTR PRESET** (**I-P**) key has no effect on correction factors loaded into the tables.

---

**Note**                    The total number of correction factors loaded using this command must be identical to the number of frequency points loaded with the “MEMory:TABLE:FREQuency” command. If they aren’t identical, an error message will be generated when you try to use the table to correct power at the **RF OUTPUT** connector.

---

### Query Syntax

$$\text{MEMory:TABLE:LOSS[:MAGNitude]}? \left[ \begin{array}{l} \text{MAXimum} \\ \text{MINimum} \end{array} \right]$$

Returned format:

*cfdata*<NL>

Where:

- *cfdata* ::= The string of correction factors (separated by commas) that are currently loaded in the table selected with the “MEMory:TABLE:SElect” command if no argument is used.
- *cfdata* ::= The maximum allowable decibel value for any correction factor if the **MAXimum** argument is specified.

- *cfdata* ::= The minimum allowable decibel value for any correction factor if the MINimum argument is specified.

## See Also

MEMory:TABLE:FREQuency

MEMory:TABLE:FREQuency:POINts?

MEMory:TABLE:LOSS[:MAGNitude]:POINts?

MEMory:TABLE:SElect

To Use the Level Correct Routine

---

## MEMory:TABLE:LOSS[:MAGNitude]:POINts?

MEMory:TABLE:LOSS[:MAGNitude]:POINts?  $\left[ \begin{array}{l} \text{MAXimum} \\ \text{MINimum} \end{array} \right]$

The “MEMory:TABLE:LOSS[:MAGNitude]:POINts?” query returns the number of correction factors loaded into the level correct table currently selected using the “MEMory:TABLE:SElect” command.

---

When the “MEMory:TABLE:LOSS[:MAGNitude]:POINts?” query is sent, the following is returned:

*poIn*<NL>

Where:

- *poIn* ::= The number of correction factors currently loaded into the selected level correct table if no argument is specified.
- *poIn* ::= The maximum number of correction factors that can be loaded into a table when the MAXimum argument is specified.
- *poIn* ::= The minimum number of correction factors that can be loaded into a table when the MINimum argument is specified.

### See Also

MEMory:TABLE:LOSS[:MAGNitude]  
MEMory:TABLE:SElect  
To Use the Level Correct Routine

---

## MEMory:TABLE:SElect

MEMory:TABLE:SElect *FDAT**tableno*

The “MEMory:TABLE:SElect” command selects the level correct table where level correct data will be loaded.

The parameter is as follows:

*tableno*            The number of the level correct table where level correct data will be loaded.  
                      The number must be an integer from 1 to 4.

---

This command selects one of four level correct tables where level correct data will be loaded using the “MEMory:TABLE:FREQuency” and “MEMory:TABLE:LOSS[:MAGNitude]” commands.

If a table number entry is made that is not within the allowable range, the level correct table entry is rejected and no action is taken by the Signal Generator. The table is preset at the factory to 1. Pressing the **INSTR PRESET** (**I-P**) key has no effect on this command.

---

**Note**                The “MEMory:TABLE:SElect” command is used to select a table for data loading only. The “[SOURce[1]:]CORRection:CSET[:SElect]” command is used to select the level correct table that is used to correct power at the Signal Generator **RF OUTPUT** connector.

---

### Query Syntax

MEMory:TABLE:SElect?

Returned format:

*FDAT**tableno*<NL>

Where:

- *tableno* ::= The level correct table currently selected to be loaded with level correct data.

### See Also

MEMory:TABLE:FREQuency  
MEMory:TABLE:LOSS[:MAGNitude]  
[SOURce[1]:]CORRection:CSET[:SElect]  
To Use the Level Correct Routine

---

## [SOURce[1]:]CORRection:CSET[:SElect]

[SOURce[1]:]CORRection:CSET[:SElect]FDAT*tableno*

The “[SOURce[1]:]CORRection:CSET[:SElect]” command selects the level correct table that is used to correct power at the Signal Generator **RF OUTPUT** connector.

The parameter is as follows:

*tableno*            The number of the level correct table that is used to correct power at the Signal Generator **RF OUTPUT** connector. The number must be an integer from 1 to 4.

---

This command selects one of four level correct tables that are used to correct power at the Signal Generator **RF OUTPUT** connector.

If a table number entry is made that is not within the allowable range, the level correct table entry is rejected and no action is taken by the Signal Generator. Pressing the **(INSTR PRESET)** (**I-P**) key selects level correct table number 1.

---

### Notes

1. The “[SOURce[1]:]CORRection:CSET[:SElect]” command is used to select the level correct table that is used to correct power at the Signal Generator **RF OUTPUT** connector. The “MEMory:TABLE:SElect” command is used to select a table for data loading.
2. If you attempt to use a level correct table that has an error, an error message is generated and no correction is applied to the Signal Generator **RF OUTPUT** connector.

---

### Query Syntax

[SOURce[1]:]CORRection:CSET[:SElect]?

Returned format:

FDAT*tableno*<NL>

Where:

- *tableno* ::= The level correct table currently selected to correct power at the Signal Generator **RF OUTPUT** connector.

### See Also

MEMory:TABLE:SElect  
[SOURce[1]:]CORRection:CSET:STATe  
[SOURce[1]:]CORRection[:STATe]  
To Use the Level Correct Routine

---

## [SOURce[1]:]CORRection:CSET:STATe

$$[\text{SOURce}[1]:]\text{CORRection:CSET:STATe} \begin{cases} \text{ON} \\ \text{OFF} \end{cases}$$

The “[SOURce[1]:]CORRection:CSET:STATe” command turns level correction on or off.

The parameters are as follows:

ON                    Turns level correction on.  
OFF                   Turns level correction off.

---

Level correction must be turned on using this command and all corrections must be turned on using the “[SOURce[1]:]CORRection[:STATe]” command in order to turn the level correct function on. The preset condition for this command is off.

---

**Note**                If you attempt to use a level correct table that has an error, an error message is generated and no correction is applied to the Signal Generator **RF OUTPUT** connector.

---

### Query Syntax

$$[\text{SOURce}[1]:]\text{CORRection:CSET:STATe?}$$

Returned format:

*state*<NL>

Where:

- *state* ::= “+1” if level correction is currently turned on.
- *state* ::= “+0” if level correction is currently turned off.

### See Also

[SOURce[1]:]CORRection:CSET[:SElect]  
[SOURce[1]:]CORRection[:STATe]  
To Use the Level Correct Routine

---

## [SOURce[1]:]CORRection[:STATe]

$$[\text{SOURce}[1]:]\text{CORRection}[:\text{STATe}] \left\{ \begin{array}{l} \text{ON} \\ \text{OFF} \end{array} \right\}$$

The “[SOURce[1]:]CORRection[:STATe]” command turns all corrections on or off.

---

**Note** This command is provided for SCPI compatibility only. In this version of the Signal Generator, the only correction available is level correction.

---

The parameters are as follows:

ON                Turns all corrections on.  
OFF               Turns all corrections off.

---

All corrections must be turned on using this command and level corrections must be turned on using the “[SOURce[1]:]CORRection:CSET:STATe” command in order to turn the level correct function on. The preset condition for this command is off.

---

**Note** If you attempt to use a level correct table that has an error, an error message is generated and no correction is applied to the Signal Generator **RF OUTPUT** connector.

---

### Query Syntax

$$[\text{SOURce}[1]:]\text{CORRection}[:\text{STATe}]?$$

Returned format:

*state*<NL>

Where:

- *state* ::= “+1” if all corrections are currently turned on.
- *state* ::= “+0” if all corrections are currently turned off.

### See Also

[SOURce[1]:]CORRection:CSET[:SElect]  
[SOURce[1]:]CORRection:CSET:STATe  
To Use the Level Correct Routine



---

## SYSTem:COMMunicate:PMETer:ADDRess

$$\text{SYSTem:COMMunicate:PMETer:ADDRess} \left\{ \begin{array}{l} \textit{address} \\ \text{MAXimum} \\ \text{MINimum} \end{array} \right\}$$

The “SYSTem:COMMunicate:PMETer:ADDRess” command allows you to change the HP-IB address that the Signal Generator uses when communicating with an external power meter during the level correct routine.

The parameters are as follows:

|                |   |
|----------------|---|
| <i>address</i> | The HP-IB address of the external power meter. The valid address range is 00 to 30 (decimal). |
| MAXimum        | Sets the power meter HP-IB address to its maximum allowable value.                            |
| MINimum        | Sets the power meter HP-IB address to its minimum allowable value.                            |

---

**Note** The “SYSTem:COMMunicate:PMETer:ADDRess” command sets the address that the Signal Generator will use when communicating with the external power meter or when receiving data from the external power meter during the level correct routine. *This command does not set the address at the power meter.*

---

The external power meter HP-IB address set at the factory is 13. Pressing the **INSTR PRESET** (**I.P**) key or sending the \*RST or SYSTem:PRESet commands will not modify the address.

### Query Syntax

$$\text{SYSTem:COMMunicate:PMETer:ADDRess?} \left[ \begin{array}{l} \text{MAXimum} \\ \text{MINimum} \end{array} \right]$$

Returned format:

*address*<NL>

Where:

- *address* ::= The current external power meter HP-IB address when no optional argument is specified.
- *address* ::= The maximum allowable power meter HP-IB address when the MAXimum argument is specified.
- *address* ::= The minimum allowable power meter HP-IB address when the MINimum argument is specified.

### See Also

To Use the Level Correct Routine

---

## **\*DMC (Define Macro Command)**

`*DMC "name", "commands"`

The “\*DMC” command allows you to create a macro that consists of any combination of Signal Generator programming commands.

The parameters are as follows:

|                 |   |
|-----------------|---|
| <i>name</i>     | The name for the macro. The name can consist of upper-case or lower-case alpha characters, numeric characters 0 through 9, or the underscore ( _ ). The name must begin with an alpha character and can be up to 255 characters long. |
| <i>commands</i> | The Signal Generator programming commands to be defined by the macro name. This must be IEEE String Program Data or Block Program Data format and can be up to 255 characters long.   |

---

Before macros that have been created by the \*DMC command can be used, they must be enabled using the \*EMC command.

### **See Also**

- \*EMC
- \*GMC?
- \*LMC?
- \*PMC
- \*RMC

---

## \*EMC (Enable Macros)

$$*EMC \begin{cases} 0 \\ 1 \end{cases}$$

The “\*EMC” command enables or disables macros created with the “\*DMC” command.

The parameters are as follows:

- 0 Disables macros created with the “\*DMC” command.
- 1 Enables macros created with the “\*DMC” command.

---

The preset condition for the “\*EMC” command is “0” (disabled).

### Query Syntax

\*EMC?

Returned format:

*state*<NL>

Where:

- *state* ::= “+0” if macros are disabled or “+1” if macros are enabled.

### See Also

- \*DMC
- \*GMC?
- \*LMC?
- \*PMC
- \*RMC

---

## **\*GMC? (Get Macro Contents Query)**

`*GMC? "name"`

The “\*GMC” query returns the commands that are in a given macro defined by the “\*DMC” command.

The parameter is as follows:

*name*                    The name of the macro for which you want to get the list of commands. This macro must have been previously defined with the “\*DMC” command.

---

The Signal Generator returns the list of macro commands in IEEE 488.2 Definite Length Arbitrary Block Response Data format.

### **See Also**

- \*DMC
- \*EMC
- \*LMC?
- \*PMC
- \*RMC

---

## **\*LMC? (List Macro Query)**

**\*LMC?**

The “\*LMC?” query returns a listing of the names of all macros that have been defined by the “\*DMC” command.

---

In response to the “\*LMC?” query, the Signal Generator will return a list of macro names defined. The macro names will be returned as string data separated by commas.

If no macros have been defined, the Signal Generator will return the empty string ( “” ) in response to the “\*LMC?” query.

### **See Also**

- \*DMC
- \*EMC
- \*GMC?
- \*PMC
- \*RMC

---

## **\*PMC (Purge Macros Command)**

\*PMC

The “\*PMC” command purges all macros that have been defined.

---

The “\*PMC” command purges all defined macros. Purged macros are erased from memory and can not be recovered. To selectively purge certain macros, use the “\*RMC” command.

### **See Also**

\*DMC

\*EMC

\*GMC?

\*LMC?

\*RMC

---

## **\*RMC (Remove Macro Command)**

`*RMC "name"`

The “\*RMC” command selectively purges a macro from the Signal Generator memory.

The parameter is as follows:

*name*            The name of the macro that you want to purge. This macro must have been previously defined with the “\*DMC” command.

---

The “\*RMC” command purges only the macro whose name is stated with the command. The purged macro is erased from memory and can not be recovered. Only one macro can be purged per “\*RMC” command. To purge all defined macros with one command, use the “\*PMC” command.

If the “\*RMC” command is sent and the macro to be purged does not exist, an error message will be generated.

### **See Also**

- \*DMC
- \*EMC
- \*GMC?
- \*LMC?
- \*PMC





---

## DISPlay[:WINDow][:STATe]

$$\text{DISPlay}[:\text{WINDow}][:\text{STATe}]\left\{\begin{array}{l} \text{ON} \\ \text{OFF} \end{array}\right\}$$

The “DISPlay[:WINDow][:STATe]” command turns the display screen on and off.

The parameters are as follows:

- ON                    Turns the display screen on.
- OFF                   Turns the display screen off.

---

The display state is stored in the instrument state registers along with other instrument state data, so if sensitive instrument settings are stored to a register, the settings are not revealed when the register is recalled. The preset condition for the “DISPlay[:WINDow][:STATe]” command is ON.

---

**Note**                    Once the display has been turned off, cycling the LINE switch off and then on will not restore the display.

---

### Query Syntax

$$\text{DISPlay}[:\text{WINDow}][:\text{STATe}]?$$

Returned format:

*state*<NL>

Where:

- *state* ::= “+1” if the display screen is currently turned on.
- *state* ::= “+0” if the display screen is currently turned off.

---

## ABORt

ABORt

The “ABORt” command resets the trigger system and places all trigger sequences in the idle state.

---

**Note**                    This command is provided for SCPI compatability only. In this version of the Signal Generator, the trigger system is always continuously initiated. When the “ABORt” command is received, the trigger system enters but then immediately exits the idle state.

---

### See Also

INITiate:CONTinuous

---

## INITiate:CONTInuous

INITiate:CONTInuous  $\left\{ \begin{array}{l} \text{ON} \\ \text{OFF} \end{array} \right\}$

The “INITiate:CONTInuous” command is used to select whether the trigger system is continuously initiated or not.

---

**Note** This command is provided for SCPI compatability only. In this version of the Signal Generator, the trigger system is always continuously initiated.

---

The parameters are as follows:

- ON Sets triggering to a state where the trigger system will immediately commence another trigger cycle after completing a trigger cycle. In this version of the Signal Generator, the “INITiate:CONTInuous” command is always set to on.
- OFF The OFF parameter option is not available in this version of the Signal Generator.

---

### Query Syntax

INITiate:CONTInuous?

Returned format:

ON<NL>

### See Also

TRIGger[:SEQuence[1]]:STARt:SOURce  
TRIGger:SEQuence2]:STOP:SOURce

---

## [SOURce[1]:]AM:STATe

$$[\text{SOURce}[1]:]\text{AM:STATe} \left\{ \begin{array}{l} \text{ON} \\ \text{OFF} \end{array} \right\}$$

The “[SOURce[1]:]AM:STATe” command turns amplitude modulation on or off.

The parameters are as follows:

ON                    Turns amplitude modulation on.  
OFF                   Turns amplitude modulation off.

---

In the current configuration of the Signal Generator, only logarithmic AM (Log AM) is supported, therefore, when AM is turned on, Log AM is automatically selected. When Log AM is turned on, the display indicates “LOG AM ON”. When the Signal Generator is set to the preset state, logarithmic AM is turned off.

### Query Syntax

$$[\text{SOURce}[1]:]\text{AM:STATe?}$$

Returned format:

*state*<NL>

Where:

- *state* ::= “+1” if AM is currently turned on.
- *state* ::= “+0” if AM is currently turned off.

### See Also

Connectors

[SOURce[1]:]AM:TYPE

---

## [SOURce[1]:]AM:TYPE

$$[\text{SOURce}[1]:]\text{AM:TYPE} \begin{cases} \text{EXPonential} \\ \text{LINear} \end{cases}$$

The “[SOURce[1]:]AM:TYPE” command is used to set the amplitude modulation type.

---

**Note** This command is provided for SCPI compatibility only. In this version of the Signal Generator, AM type is not selectable and is always set to exponential (logarithmic).

---

The parameters are as follows:

**EXPonential** In this version of the Signal Generator, exponential (logarithmic) amplitude modulation is the only modulation type available.

**LINear** Linear amplitude modulation is not available in this version of the Signal Generator. If this parameter is issued, an error message will result.

---

### Query Syntax

[SOURce[1]:]AM:TYPE?

Returned format:

EXP<NL>

### See Also

[SOURce[1]:]AM:STATE

---

## [SOURce[1]:]FM:COUPLing

$$[SOURce[1]:]FM:COUPLing \begin{cases} AC \\ DC \end{cases}$$

The “[SOURce[1]:]FM:COUPLing” command selects either AC or DC coupling for the **EXT FM** connector.

The parameters are as follows:

AC                    AC couples the **EXT FM** connector.

DC                    DC couples the **EXT FM** connector.

---

When the “[SOURce[1]:]FM:COUPLing” command is sent, the display indicates the current status of FM coupling (when FM is turned on).

When DC FM is off, the Signal Generator circuitry is configured so that the **FM IN** connector will accept a modulating signal with a minimum rate of 1 kHz. When DC FM is on, the **EXT FM** connector will accept a modulating signal with a minimum rate of 0 Hz (dc). When the Signal Generator is set to the preset state, FM coupling is set to ac.

### Advantages of DC FM

When DC FM is selected, the modulation index is unlimited.

$$modulationindex = \frac{peakdeviation}{modulationrate}$$

Where modulation rate can range down to 0 Hz (dc).

### Disadvantages of DC FM

When DC FM is enabled, the Signal Generator internal phase locked loop circuits are disabled, causing the output frequency accuracy and stability to be degraded.

### Query Syntax

[SOURce[1]:]FM:COUPLing?

Returned format:

*coupl*<NL>

Where:

- *coupl* ::= “AC” if the **EXT FM** connector is currently AC coupled.
- *coupl* ::= “DC” if the **EXT FM** connector is currently DC coupled.

### See Also

Connectors

[SOURce[1]:]FM:SENSitivity?

[SOURce[1]:]FM:STATe

---

## [SOURce[1]:]FM:SENSitivity?

[SOURce[1]:]FM:SENSitivity? 

|         |
|---------|
| MAXimum |
| MINimum |
| DEFault |

The “[SOURce[1]:]FM:SENSitivity?” query returns the current FM sensitivity.

---

FM sensitivity is a ratio of the frequency deviation from the carrier per unit change of the modulating signal amplitude. In the Signal Generator, sensitivity is displayed as the carrier deviation per volt. Note that FM sensitivity is not selectable; it is pre-determined by the chosen carrier frequency.

When the “[SOURce[1]:]FM:SENSitivity?” query is sent, the following is returned:

*sens*<NL>

Where:

- *sens* ::= The current FM sensitivity if no argument is specified. This will always be one of five values (5 MHz/V, 1.28 MHz/V, 320 kHz/V, 80 kHz/V, or 20 kHz/V) depending on the current carrier frequency.
- *sens* ::= The maximum FM sensitivity that can be obtained when the MAXimum argument is specified.
- *sens* ::= The minimum FM sensitivity that can be obtained when the MINimum argument is specified.
- *sens* ::= The preset FM sensitivity when the DEFault argument is specified.

---

**Note** When a frequency multiplier is used, the sensitivity read using the “[SOURce[1]:]FM:SENSitivity?” query will be multiplied by the multiplier value.

---

### See Also

Connectors  
[SOURce[1]:]FM:STATe  
[SOURce[1]:]FREQuency:MULTiplier  
UNIT:FREQuency

---

## [SOURce[1]:]FM:STATe

$$[\text{SOURce}[1]:]\text{FM:STATe} \left\{ \begin{array}{l} \text{ON} \\ \text{OFF} \end{array} \right\}$$

The “[SOURce[1]:]FM:STATe” command turns frequency modulation on or off.

The parameters are as follows:

ON                    Turns frequency modulation on.  
OFF                   Turns frequency modulation off.

---

When frequency modulation is turned on, the display indicates either “AC FM” or “DC FM”, depending on whether or not FM coupling has been set to AC or DC. When the Signal Generator is set to the preset state, frequency modulation is turned off.

### Query Syntax

$$[\text{SOURce}[1]:]\text{FM:STATe?}$$

Returned format:

*state*<NL>

Where:

- *state* ::= “+1” if FM is currently turned on.
- *state* ::= “+0” if FM is currently turned off.

### See Also

Connectors  
[SOURce[1]:]FM:COUPling  
[SOURce[1]:]FM:SENSitivity?

---

## **[SOURCE[1]:]MODulation:AOff**

`[SOURCE[1]:]MODulation:AOff`

The “[SOURCE[1]:]MODulation:AOff” command turns all modulations (AM, FM, and pulse modulation) off.

---

The “[SOURCE[1]:]MODulation:AOff” command turns all modulations off. There is no method for turning all modulations on using this command. To turn all modulations on, the “[SOURCE[1]:]MODulation:STATE” command or the individual modulation state commands must be used.



## See Also

[SOURCE[1]:]AM:STATe

[SOURCE[1]:]FM:STATe

[SOURCE[1]:]MODulation:STATe

[SOURCE[1]:]PULM:STATe

---

## [SOURce[1]:]MODulation:STATe

$$[\text{SOURce}[1]:]\text{MODulation:STATe} \begin{cases} \text{ON} \\ \text{OFF} \end{cases}$$

The “[SOURce[1]:]MODulation:STATe” command turns all modulations (AM, FM, and pulse modulation) on or off.

The parameters are as follows:

ON                    Turns all modulations on.

OFF                   Turns all modulations off.

---

### Query Syntax

$$[\text{SOURce}[1]:]\text{MODulation:STATe?}$$

Returned format:

*state*<NL>

Where:

- *state* ::= “+1” if any modulation (AM, FM, or pulse modulation) is currently turned on.
- *state* ::= “+0” if all modulations (AM, FM, and pulse modulation) are currently turned off.

### See Also

[SOURce[1]:]AM:STATe

[SOURce[1]:]FM:STATe

[SOURce[1]:]MODulation:AOFF

[SOURce[1]:]PULM:STATe

---

## [SOURCE[1]:]PULM:EXTernal:POLarity

$$[\text{SOURCE}[1]:]\text{PULM:EXTernal:POLarity} \left\{ \begin{array}{l} \text{NORMal} \\ \text{INVerted} \end{array} \right\}$$

The “[SOURCE[1]:]PULM:EXTernal:POLarity” command selects either inverted or non-inverted polarity for the external pulse input at the **PULSE/TRIG IN, GATE IN** connector.

The parameters are as follows:

|          |  |
|----------|--|
| NORMal   | Selects non-inverted polarity for the external pulse input at the <b>PULSE/TRIG IN, GATE IN</b> connector. |
| INVerted | Selects inverted polarity for the external pulse input at the <b>PULSE/TRIG IN, GATE IN</b> connector.     |

---

When inverted external pulse modulation is selected, the display indicates “PULSE INV”.

When the Signal Generator is set to the preset state, the external pulse input polarity is set to non-inverted (PULSE NML).

---

**Note** The polarity of the external pulse input can be set at any time, but the pulse source must be set to external using the “[SOURCE[1]:]PULM:SOURce” command and pulse modulation must be turned on using the “[SOURCE[1]:]PULM:STATe” command before external pulse mode is used.

---

### Query Syntax

$$[\text{SOURCE}[1]:]\text{PULM:EXTernal:POLarity?}$$

Returned format:

*polarity*<NL>

Where:

- *polarity* ::= “NORM” if the polarity of the external pulse input is currently set to non-inverted.
- *polarity* ::= “INV” if the polarity of the external pulse input is currently set to inverted.

---

**Note** This command is only valid when Option 1E2 is installed.

---

### See Also

Connectors  
[SOURCE[1]:]PULM:SOURce  
[SOURCE[1]:]PULM:STATe

---

## [SOURce[1]:]PULM:SOURce

$$[\text{SOURce}[1]:]\text{PULM:SOURce} \begin{cases} \text{INTernal} \\ \text{EXTernal} \end{cases}$$

The “[SOURce[1]:]PULM:SOURce” command sets the pulse modulation source to either internal or external.

The parameters are as follows:

INT                Selects the internal pulse modulation source.

EXT                Selects the external pulse modulation source.

---

When the Signal Generator is set to the preset state, the pulse modulation source is set to external.

The pulse modulation source is set to external for external and inverted external pulse modulation. The pulse modulation source is set to internal for internal, internal triggered, doublet, and gated pulse modulation.

### Query Syntax

$$[\text{SOURce}[1]:]\text{PULM:SOURce?}$$

Returned format:

*source*<NL>

Where:

- *source* ::= “INT” if the pulse modulation source is internal.
- *source* ::= “EXT” if the pulse modulation source is external.

---

**Note**                This command is only valid when Option 1E2 is installed.

---

### See Also

Connectors

[SOURce[1]:]PULM:STATe

[SOURce[1]:]PULM:EXTernal:POLarity

TRIGger[:SEQuence[1]:]STARt]:SOURce

---

## [SOURce[1]:]PULM:STATe

$$[\text{SOURce}[1]:]\text{PULM:STATe} \begin{cases} \text{ON} \\ \text{OFF} \end{cases}$$

The “[SOURce[1]:]PULM:STATe” command turns pulse modulation on or off.

The parameters are as follows:

ON                    Turns pulse modulation on.  
OFF                   Turns pulse modulation off.

---

When the Signal Generator is set to the preset state, pulse modulation is turned off.

When pulse modulation is turned off, all pulse modulation modes are off. When pulse modulation is turned on, the pulse modulation mode is determined by the parameters set with the “[SOURce[1]:]PULM:SOURce”, “[SOURce[1]:]PULM:EXTeRnal:POLarity”, “TRIGger[:]SEQUence[1]:STARt]:SOURce”, “TRIGger:SEQUence2]:STOP:SOURce”, and “[SOURce[1]:]PULSe:DOUBle[:]STATe” commands.

### Query Syntax

$$[\text{SOURce}[1]:]\text{PULM:STATe?}$$

Returned format:

*state*<NL>

Where:

- *state* ::= “+1” if pulse modulation is currently on.
- *state* ::= “+0” if pulse modulation is currently off.

---

**Note**                    This command is only valid when Option 1E2 is installed.

---

### See Also

[SOURce[1]:]PULM:EXTeRnal:POLarity  
[SOURce[1]:]PULM:SOURce  
[SOURce[1]:]PULSe:DOUBle[:]STATe  
TRIGger[:]SEQUence[1]:STARt]:SOURce  
TRIGger:SEQUence2]:STOP:SOURce

---

## [SOURce[1]:]PULSe:DELay

$$[\text{SOURce}[1]:]\text{PULSe:DELay} \left\{ \begin{array}{l} \textit{delay} \\ \text{MAXimum} \\ \text{MINimum} \\ \text{UP} \\ \text{DOWN} \\ \text{DEFault} \end{array} \right\}$$

The “[SOURce[1]:]PULSe:DELay” command selects the pulse delay to be used in internal, doublet, or triggered internal pulse modes.

The parameters are as follows:

|              |  |
|--------------|--|
| <i>delay</i> | Sets the pulse delay. The allowable range for the parameter is $-419$ ms to $+419$ ms when using internal pulse mode or $+225$ ns to $+419$ ms when using internal triggered or doublet pulse modes. |
| MAXimum      | Sets the pulse delay to the maximum allowable value.   |
| MINimum      | Sets the pulse delay to the minimum allowable value.   |
| UP           | Increases the pulse delay by the current pulse delay increment value.  |
| DOWN         | Decreases the pulse delay by the current pulse delay increment value.  |
| DEFault      | Sets the pulse delay to its default (preset) value.  |

---

Numeric pulse delay entries have a resolution of 25 ns; entries with a resolution finer than 25 ns will be rounded to the nearest 25 ns. If a pulse delay entry is made that is not within the allowable parameter range, an error message will be generated and the parameter will be set to either its maximum or minimum limit. The preset value for pulse delay is  $1 \mu\text{s}$ .

- 
- Notes**
1. In triggered internal pulse mode, the sum of pulse width and pulse delay can not exceed 419 ms.
  2. The pulse delay can be set at any time, but other parameters must be set before internal, doublet, or triggered internal pulse mode is used.
- 

### Query Syntax

$$[\text{SOURce}[1]:]\text{PULSe:DELay?} \left[ \begin{array}{l} \text{MAXimum} \\ \text{MINimum} \\ \text{DEFault} \end{array} \right]$$

Returned format:

*delay*<NL>

Where:

- *delay* ::= The current pulse delay if no argument is specified.
- *delay* ::= The maximum pulse delay that can be set if the MAXimum argument is specified.
- *delay* ::= The minimum pulse delay that can be set if the MINimum argument is specified.

- *delay* ::= The default (preset) pulse delay if the DEFault argument is specified.

---

**Note** This command is only valid when Option 1E2 is installed.

---

### See Also

[SOURce[1]:]PULSe:DELay:STEP  
[SOURce[1]:]PULM:SOURce  
[SOURce[1]:]PULM:STATe  
[SOURce[1]:]PULSe:WIDTh  
[SOURce[1]:]TRIGger[:SEQuence[1]]:STARt]:SOURce

---

## [SOURce[1]:]PULSe:DELAy:STEP

$$[\text{SOURce}[1]:]\text{PULSe:DELAy:STEP}[\text{:INCRement}] \left\{ \begin{array}{l} \textit{incr} \\ \text{MAXimum} \\ \text{MINimum} \\ \text{DEFault} \end{array} \right\}$$

The “[SOURce[1]:]PULSe:DELAy:STEP” command selects the increment value for pulse delay.

The parameters are as follows:

|             |  |
|-------------|--|
| <i>incr</i> | Sets the increment value for pulse delay. The allowable range for the parameter is 25 ns to 838 ms in internal pulse mode or 25 ns to 418.775 ms in internal triggered or doublet pulse modes. |
| MAXimum     | Sets the pulse delay increment value to its maximum allowable value.   |
| MINimum     | Sets the pulse delay increment value to its minimum allowable value.   |
| DEFault     | Sets the pulse delay increment value to its default (preset) value.  |

---

When the “UP” or “DOWN” parameters are used with the “[SOURce[1]:]PULSe:DELAy” command, the pulse delay will be increased or decreased by a step size set with the “[SOURce[1]:]PULSe:DELAy:STEP” command.

Numeric pulse delay increment value entries have a resolution of 25 ns; entries with a resolution finer than 25 ns will be rounded to the nearest 25 ns. If a pulse delay increment value entry is made that is not within the allowable parameter range, it will be set to either its maximum or minimum limit. The preset value for the pulse delay increment value is 25 ns.

### Query Syntax

$$[\text{SOURce}[1]:]\text{PULSe:DELAy:STEP}[\text{:INCRement}]? \left[ \begin{array}{l} \text{MAXimum} \\ \text{MINimum} \\ \text{DEFault} \end{array} \right]$$

Returned format:

*incr*<NL>

Where:

- *incr* ::= The current pulse delay increment value if no argument is specified.
- *incr* ::= The maximum pulse delay increment value that can be set if the MAXimum argument is specified.
- *incr* ::= The minimum pulse delay increment value that can be set if the MINimum argument is specified.
- *incr* ::= The default (preset) pulse delay increment value if the DEFault argument is specified.

---

**Note** This command is only valid when Option 1E2 is installed.

---



## See Also

[SOURce[1]:]PULSe:DELay

---

## [SOURce[1]:]PULse:DOUBle[:STATe]

$$[\text{SOURce}[1]:]\text{PULse:DOUBle}[:\text{STATe}] \left\{ \begin{array}{l} \text{ON} \\ \text{OFF} \end{array} \right\}$$

The “[SOURce[1]:]PULM:STATe” command turns doublet pulse mode on or off.

The parameters are as follows:

- ON                    Turns doublet pulse mode on.
- OFF                   Turns doublet pulse mode off.

---

When the Signal Generator is set to the preset state, doublet pulse mode is turned off.

When doublet pulse mode is on, the signal generator generates two RF pulses with each trigger event. The trigger event is supplied by an external gated signal source.

### Query Syntax

$$[\text{SOURce}[1]:]\text{PULse:DOUBle}[:\text{STATe}]?$$

Returned format:

*state*<NL>

Where:

- *state* ::= “+1” if doublet pulse mode is currently on.
- *state* ::= “+0” if doublet pulse mode is currently off.

---

**Note**                    This command is only valid when Option 1E2 is installed.

---

### See Also

[SOURce[1]:]PULM:EXTernal:POLarity  
[SOURce[1]:]PULM:STATe  
[SOURce[1]:]PULM:SOURce  
TRIGger[:SEQUence[1]:]STARt[:SOURce  
TRIGger:SEQUence2[:STOP:SOURce  
Chapter 3, “To Generate a Doublet Pulse”

---

## [SOURce[1]:]PULSe:FREQuency

[SOURce[1]:]PULSe:FREQuency  $\left\{ \begin{array}{l} freq \\ MAXimum \\ MINimum \\ UP \\ DOWN \\ DEFault \end{array} \right\}$

The “[SOURce[1]:]PULSe:FREQuency” command selects the pulse repetition frequency (PRF). PRF is used during internal pulse modulation or gated pulse modulation.

The parameters are as follows:

|             |  |
|-------------|--|
| <i>freq</i> | Sets the pulse repetition frequency (PRF). The allowable range for the parameter is 2.5 Hz to 3.3 MHz. |
| MAXimum     | Sets the pulse repetition frequency to the maximum allowable value.                                    |
| MINimum     | Sets the pulse repetition frequency to the minimum allowable value.                                    |
| UP          | Increases the pulse repetition frequency by the current pulse repetition frequency increment value.    |
| DOWN        | Decreases the pulse repetition frequency by the current pulse repetition frequency increment value.    |
| DEFault     | Sets the pulse repetition frequency to its default (preset) value.                                     |

---

If a pulse repetition frequency entry is made that is not within the allowable parameter range, an error message will be generated and the parameter will be set to either its upper or lower limit. The preset value for pulse repetition frequency is 10 kHz.

The resolution for the PRF parameter can be found by rounding the reciprocal of PRF (1/PRF or PRI) to the nearest 25 ns and then taking the reciprocal of that value. For example, assume a PRF of 432 kHz is needed. The reciprocal of 432 kHz is 1/432 kHz or 2315 ns. This value rounded to the nearest 25 ns is 2325 ns. Taking the reciprocal of 2325 ns is 1/2325 ns or 430.107526 kHz. The closest you could set the PRF parameter to the required value of 432 kHz would be 430.107526 kHz.

- 
- Notes**
1. Changing the PRF parameter automatically causes the PRI parameter set with the “[SOURce[1]:]PULSe:PERiod” command to change since these two parameters are reciprocals of each other.
  2. The pulse repetition frequency can be set at any time, but other parameters must be set before internal or gated pulse mode is used.
-

## Query Syntax

[SOURCE[1]:]PULSE:FREQUENCY?  $\begin{bmatrix} \text{MAXimum} \\ \text{MINimum} \\ \text{DEFault} \end{bmatrix}$

Returned format:

*freq*<NL>

Where:

- *freq* ::= The current pulse repetition frequency if no argument is specified.
- *freq* ::= The maximum pulse repetition frequency that can be set if the MAXimum argument is specified.
- *freq* ::= The minimum pulse repetition frequency that can be set if the MINimum argument is specified.
- *freq* ::= The default pulse repetition frequency if the DEFault argument is specified.

---

**Note**            This command is only valid when Option 1E2 is installed.

---

## See Also

[SOURCE[1]:]PULM:SOURce  
[SOURCE[1]:]PULM:STATe  
[SOURCE[1]:]PULSE:FREQUENCY:STEP  
[SOURCE[1]:]PULSE:PERiod

---

## [SOURce[1]:]PULSe:FREQUency:STEP

$$[SOURce[1]:]PULSe:FREQUency:STEP[:INCRement] \left\{ \begin{array}{l} incr \\ MAXimum \\ MINimum \\ DEFault \end{array} \right\}$$

The “[SOURce[1]:]PULSe:FREQUency:STEP” command selects the increment value for pulse repetition frequency.

The parameters are as follows:

|             |  |
|-------------|--|
| <i>incr</i> | Sets the increment value for pulse repetition frequency (PRF). The allowable range for the parameter is 0.001 Hz to 3.2999975 MHz. |
| MAXimum     | Sets the pulse repetition frequency increment value to its maximum allowable value.  |
| MINimum     | Sets the pulse repetition frequency increment value to its minimum allowable value.  |
| DEFault     | Sets the pulse repetition frequency increment value to its default (preset) value.   |

---

When the “UP” or “DOWN” parameters are used with the “[SOURce[1]:]PULSe:FREQUency” command, the pulse repetition frequency will be increased or decreased by a step size set with the “[SOURce[1]:]PULSe:FREQUency:STEP” command.

If a pulse repetition frequency increment value entry is made that is not within the allowable parameter range, an error message will be generated and the parameter will be set to either its maximum or minimum limit. The preset value for the pulse repetition frequency increment value is 100 Hz.

The resolution for the PRF increment value is 1 MHz. Entries with a resolution lower than 1 MHz are rounded to the nearest MHz.

### Query Syntax

$$[SOURce[1]:]PULSe:FREQUency:STEP[:INCRement]? \left[ \begin{array}{l} MAXimum \\ MINimum \\ DEFault \end{array} \right]$$

Returned format:

*incr* <NL>

Where:

- *incr* ::= The current pulse repetition frequency increment value if no argument is specified.
- *incr* ::= The maximum pulse repetition frequency increment value that can be set if the MAXimum argument is specified.
- *incr* ::= The minimum pulse repetition frequency increment value that can be set if the MINimum argument is specified.

- *incr* ::= The default (preset) pulse repetition frequency increment value if the DEFault argument is specified.

---

**Note** This command is only valid when Option 1E2 is installed.

---

**See Also**

[SOURce[1]:]PULSe:FREQuency

---

## [SOURce[1]:]PULSe:PERiod

[SOURce[1]:]PULSe:PERiod  $\left\{ \begin{array}{l} \textit{period} \\ \text{MAXimum} \\ \text{MINimum} \\ \text{UP} \\ \text{DOWN} \\ \text{DEFault} \end{array} \right\}$

The “[SOURce[1]:]PULSe:PERiod” command selects the pulse repetition interval (PRI). PRI is used during internal pulse modulation or gated pulse modulation.

The parameters are as follows:

|               |  |
|---------------|--|
| <i>period</i> | Sets the pulse repetition interval (PRI). The allowable range for the parameter is 300 ns to 419 ms. |
| MAXimum       | Sets the pulse repetition interval to the maximum allowable value.                                   |
| MINimum       | Sets the pulse repetition interval to the minimum allowable value.                                   |
| UP            | Increases the pulse repetition interval by the current pulse repetition interval increment value.    |
| DOWN          | Decreases the pulse repetition interval by the current pulse repetition interval increment value.    |
| DEFault       | Sets the pulse repetition interval to its default (preset) value.                                    |

---

If a pulse repetition interval entry is made that is not within the allowable parameter range, an error message will be generated and the parameter will be set to either its upper or lower limit. The preset value for pulse repetition interval is 100 ms.

The resolution for PRI parameter entries is 25 ns; entries with a resolution finer than 25 ns will be rounded to the nearest 25 ns.

- 
- Notes**
1. Changing the PRI parameter automatically causes the PRF parameter set with the “[SOURce[1]:]PULSe:FREQUENCY” command to change since these two parameters are reciprocals of each other.
  2. The pulse repetition interval can be set at any time, but other parameters must be set before internal or gated pulse mode is used.
- 

### Query Syntax

[SOURce[1]:]PULSe:PERiod?  $\left[ \begin{array}{l} \text{MAXimum} \\ \text{MINimum} \\ \text{DEFault} \end{array} \right]$

Returned format:

*period*<NL>

Where:

- *period* ::= The current pulse repetition interval if no argument is specified.
- *period* ::= The maximum pulse repetition interval that can be set if the MAXimum argument is specified.
- *period* ::= The minimum pulse repetition interval that can be set if the MINimum argument is specified.
- *period* ::= The default (preset) pulse repetition interval if the DEFault argument is specified.

---

**Note**            This command is only valid when Option 1E2 is installed.

---

### See Also

[SOURce[1]:]PULM:SOURce  
[SOURce[1]:]PULM:STATe  
[SOURce[1]:]PULSe:FREQUency  
[SOURce[1]:]PULSe:PERiod:STEP



---

## [SOURce[1]:]PULSe:PERiod:STEP

$$[SOURce[1]:]PULSe:PERiod:STEP[:INCRement] \left\{ \begin{array}{l} incr \\ MAXimum \\ MINimum \\ DEFault \end{array} \right\}$$

The “[SOURce[1]:]PULSe:PERiod:STEP” command selects the increment value for pulse repetition interval.

The parameters are as follows:

|             |   |
|-------------|---|
| <i>incr</i> | Sets the increment value for pulse repetition interval (PRI). The allowable range for the parameter is 25 ns to 418.9997. |
| MAXimum     | Sets the pulse repetition interval increment value to its maximum allowable value.  |
| MINimum     | Sets the pulse repetition interval increment value to its minimum allowable value.  |
| DEFault     | Sets the pulse repetition interval increment value to its default (preset) value.   |

---

When the “UP” or “DOWN” parameters are used with the “[SOURce[1]:]PULSe:PERiod” command, the pulse repetition interval will be increased or decreased by a step size set with the “[SOURce[1]:]PULSe:PERiod:STEP” command.

If a pulse repetition interval increment value entry is made that is not within the allowable parameter range, an error message will be generated and the parameter will be set to either its maximum or minimum limit. The preset value for the pulse repetition interval increment value is 1  $\mu$ s.

The resolution for PRI increment value entries is 25 ns; entries with a resolution finer than 25 ns will be rounded to the nearest 25 ns.

### Query Syntax

$$[SOURce[1]:]PULSe:PERiod:STEP[:INCRement]? \left[ \begin{array}{l} MAXimum \\ MINimum \\ DEFault \end{array} \right]$$

Returned format:

*incr*<NL>

Where:

- *incr* ::= The current pulse repetition interval increment value if no argument is specified.
- *incr* ::= The maximum pulse repetition interval increment value that can be set if the MAXimum argument is specified.
- *incr* ::= The minimum pulse repetition interval increment value that can be set if the MINimum argument is specified.
- *incr* ::= The default (preset) pulse repetition interval increment value if the DEFault argument is specified.

---

**Note** This command is only valid when Option 1E2 is installed.

---

**See Also**

[SOURce[1]:]PULSe:PERiod

---

## [SOURce[1]:]PULSe:TRANSition[:LEADing]

$$[\text{SOURce}[1]:]\text{PULSe:TRANSition} \left\{ \begin{array}{l} \text{:LEADing} \\ \text{:TRAIling} \end{array} \right\} \left\{ \begin{array}{l} \text{SLOW} \\ \text{MEDium} \\ \text{FAST} \end{array} \right\}$$

The “[SOURce[1]:]PULSe:TRANSition[:LEADing]” command allows you to manually select either a slow (300 ns), medium (30 ns), or fast (10 ns) pulse risetime.

---

**Note** Manual pulse risetime selection must be turned on using the “[SOURce[1]:]PULSe:TRANSition:STATE” command for the chosen pulse risetime to be used by the Signal Generator.

---

The parameters are as follows:

SLOW Selects a 300 ns manual pulse risetime.  
MEDium Selects a 30 ns manual pulse risetime.  
FAST Selects a 10 ns manual pulse risetime.

---

**Note** When you set the risetime using the “[SOURce[1]:]PULSe:TRANSition[:LEADing]” command, the falltime set with the “[SOURce[1]:]PULSe:TRANSition:TRAIling” command will be automatically set to the same value. There is no method of changing the falltime independently of the risetime.

---

When the Signal Generator is set to the preset state, manual pulse risetime is set to FAST.

### Application for Manual Pulse Risetime Selection

A series of low pass filters are used to reduce output harmonics when the Signal Generator output frequency is less than 1 GHz. The filter passbands can be narrow enough to induce pulse ringing if the pulse risetime is too fast.

The Signal Generator automatically selects a slower pulse risetime (when “[SOURce[1]:]PULSe:TRANSition:STATE” is set to OFF) as the carrier frequency is decreased to minimize ringing and video feedthrough caused by the low pass filtering. The appropriate pulse risetime is automatically selected as follows:

| Output Frequency     | Pulse Risetime |
|----------------------|----------------|
| 10 MHz to 64 MHz     | 300 ns         |
| 64 MHz to 500 MHz    | 30 ns          |
| Greater than 500 MHz | 10 ns          |

In applications where a faster pulse risetime than that shown in the table is needed at a particular output frequency, you can manually choose a pulse risetime. The disadvantage of choosing a faster pulse risetime is degraded pulse performance.

## Query Syntax

$$[\text{SOURCE}[1]:]\text{PULSE:TRANSITION}\left\{\begin{array}{l}[:\text{LEADing}] \\ : \text{TRAILing}\end{array}\right\}?$$

Returned format:

*time*<NL>

Where:

- *time* ::= “SLOW” if the manually selected pulse risetime (and falltime) is currently set to slow (300 ns).
- *time* ::= “MED” if the manually selected pulse risetime (and falltime) is currently set to medium (30 ns).
- *time* ::= “FAST” if the manually selected pulse risetime (and falltime) is currently set to fast (10 ns).

---

**Note** This command is only valid when Option 1E2 is installed.

---

## See Also

[SOURCE[1]:]PULSE:TRANSITION:STATE

---

## [SOURce[1]:]PULSe:TRANsition:STATe

$$[SOURce[1]:]PULSe:TRANsition:STATe \begin{cases} ON \\ OFF \end{cases}$$

The “[SOURce[1]:]PULSe:TRANsition:STATe” command turns manual pulse risetime selection on or off.

The parameters are as follows:

- ON Turns manual pulse risetime selection on (you can select one of three pulse risetimes using the “[SOURce[1]:]PULSe:TRANsition[:LEADing]” command).
- OFF Turns manual pulse risetime selection off (the instrument automatically selects optimum pulse risetime for the selected carrier frequency range).

---

Once manual pulse risetime selection has been turned on using the “[SOURce[1]:]PULSe:TRANsition:STATe” command, one of three pulse risetimes can be selected using the “[SOURce[1]:]PULSe:TRANsition[:LEADing]” command.

When the Signal Generator is set to the preset state, pulse risetime selection is turned off.

### Application for Manual Pulse Risetime Selection

A series of low pass filters are used to reduce output harmonics when the Signal Generator output frequency is less than 1 GHz. The filter passbands can be narrow enough to induce pulse ringing if the pulse risetime is too fast.

The Signal Generator automatically selects a slower pulse risetime as the carrier frequency is decreased to minimize ringing and video feedthrough caused by the low pass filtering. The appropriate pulse risetime is automatically selected as follows:

| Output Frequency     | Pulse Risetime |
|----------------------|----------------|
| 10 MHz to 64 MHz     | 300 ns         |
| 64 MHz to 500 MHz    | 30 ns          |
| Greater than 500 MHz | 10 ns          |

In applications where a faster pulse risetime than that shown in the table is needed at a particular output frequency, you can manually choose a pulse risetime. The disadvantage of choosing a faster pulse risetime is degraded pulse performance.

## Query Syntax

```
[SOURce[1]:]PULSe:TRANsition:STATe?
```

Returned format:

```
state<NL>
```

Where:

- *state* ::= “+1” if manual pulse risetime selection is currently on.
- *state* ::= “+0” if manual pulse risetime selection is currently off.

---

**Note** This command is only valid when Option 1E2 is installed.

---

## See Also

```
[SOURce[1]:]PULSe:TRANsition[:LEADing]
```

---

## [SOURce[1]:]PULSe:WIDTh

$$[\text{SOURce}[1]:]\text{PULSe:WIDTh} \left\{ \begin{array}{l} \textit{width} \\ \text{MAXimum} \\ \text{MINimum} \\ \text{UP} \\ \text{DOWN} \\ \text{DEFault} \end{array} \right\}$$

The “[SOURce[1]:]PULSe:WIDTh” command selects the pulse width to be used in internal, triggered internal, doublet, and gated pulse modes.

The parameters are as follows:

|              |  |
|--------------|--|
| <i>width</i> | Sets the pulse width. The allowable range for the parameter is 0 ns to 419 ms. |
| MAXimum      | Sets the pulse width to the maximum allowable value.                           |
| MINimum      | Sets the pulse width to the minimum allowable value.                           |
| UP           | Increases the pulse width by the current pulse width increment value.          |
| DOWN         | Decreases the pulse width by the current pulse width increment value.          |
| DEFault      | Sets the pulse width to its default (preset) value.                            |

---

Numeric pulse width entries have a resolution of 25 ns; entries with a resolution finer than 25 ns will be rounded to the nearest 25 ns. If a pulse width entry is made that is not within the allowable parameter range, an error message will be generated and the parameter will be set to either its maximum or minimum limit. The preset value for pulse width is 10  $\mu$ s.

- 
- Notes**
1. In triggered internal pulse mode, the sum of pulse width and pulse delay can not exceed 419 ms.
  2. The pulse width can be set at any time, but other parameters must be set before internal, triggered internal, doublet, or gated pulse mode is used.
- 

### Query Syntax

$$[\text{SOURce}[1]:]\text{PULSe:WIDTh?} \left[ \begin{array}{l} \text{MAXimum} \\ \text{MINimum} \\ \text{DEFault} \end{array} \right]$$

Returned format:

*width*<NL>

Where:

- *width* ::= The current pulse width if no argument is specified.
- *width* ::= The maximum pulse width that can be set if the MAXimum argument is specified.
- *width* ::= The minimum pulse width that can be set if the MINimum argument is specified.
- *width* ::= The default (preset) pulse width if the DEFault argument is specified.

---

**Note** This command is only valid when Option 1E2 is installed.

---

### **See Also**

[SOURce[1]:]PULM:SOURce  
[SOURce[1]:]PULM:STATe  
[SOURce[1]:]PULSe:DELay  
[SOURce[1]:]PULSe:WIDTh:STEP  
TRIGger[:SEQuence[1]:]STARt]:SOURce



---

## [SOURce[1]:]PULSe:WIDTh:STEP

$$[\text{SOURce}[1]:]\text{PULSe:WIDTh:STEP}[\text{:INCRement}] \left\{ \begin{array}{l} \textit{incr} \\ \text{MAXimum} \\ \text{MINimum} \\ \text{DEFault} \end{array} \right\}$$

The “[SOURce[1]:]PULSe:WIDTh:STEP” command selects the increment value for pulse width.

The parameters are as follows:

|             |   |
|-------------|---|
| <i>incr</i> | Sets the increment value for pulse width. The allowable range for the parameter is 25 ns to 419 ms. |
| MAXimum     | Sets the pulse width increment value to its maximum allowable value.                                |
| MINimum     | Sets the pulse width increment value to its minimum allowable value.                                |
| DEFault     | Sets the pulse width increment value to its default (preset) value.                                 |

---

When the “UP” or “DOWN” parameters are used with the “[SOURce[1]:]PULSe:WIDTh” command, the pulse width will be increased or decreased by a step size set with the “[SOURce[1]:]PULSe:WIDTh:STEP” command.

Numeric pulse width increment value entries have a resolution of 25 ns; entries with a resolution finer than 25 ns will be rounded to the nearest 25 ns. If a pulse width increment value entry is made that is not within the allowable parameter range, an error message will be generated and the parameter will be set to either its maximum or minimum limit. The preset value for the pulse width increment value is 100 ns.

### Query Syntax

$$[\text{SOURce}[1]:]\text{PULSe:WIDTh:STEP}[\text{:INCRement}]? \left[ \begin{array}{l} \text{MAXimum} \\ \text{MINimum} \\ \text{DEFault} \end{array} \right]$$

Returned format:

*incr*<NL>

Where:

- *incr* ::= The current pulse width increment value if no argument is specified.
- *incr* ::= The maximum pulse width increment value that can be set if the MAXimum argument is specified.
- *incr* ::= The minimum pulse width increment value that can be set if the MINimum argument is specified.
- *incr* ::= The default (preset) pulse width increment value if the DEFault argument is specified.

---

**Note** This command is only valid when Option 1E2 is installed.

---

**See Also**

[SOURce[1]:]PULSe:WIDTh

:START]:SOURCE|

---

## TRIGger[:SEquence[1]]:START]:SOURCE

TRIGger [ :SEquence [ 1 ] | :START ] :SOURCE  $\left\{ \begin{array}{l} \text{IMMediate} \\ \text{EXTernal} \end{array} \right\}$

The “TRIGger[:SEquence[1]]:START]:SOURCE” command sets the pulse trigger source.

The parameters are as follows:

IMMediate      Selects immediate pulse triggering (no external trigger).

EXTernal        Selects external pulse triggering.

---

When the pulse trigger source has been set to EXTernal, an RF pulse will occur at the **RF OUTPUT** connector whenever a valid trigger signal occurs at the **PULSE/TRIG IN, GATE IN** connector. An external pulse trigger source is only valid when the pulse source set with the “[SOURCE[1]:PULM:SOURCE” command is internal.

The preset value for pulse trigger source is immediate (no external pulse trigger).

### Query Syntax

TRIGger [ :SEquence [ 1 ] | :START ] :SOURCE?

Returned format:

*source*<NL>

Where:

- *source* ::= “IMM” if the pulse trigger source is currently set to immediate (no external pulse trigger).
- *source* ::= “EXT” if the pulse trigger source is currently set to external.

### See Also

Connectors  
[SOURCE[1]:PULM:SOURCE  
[SOURCE[1]:PULM:STATE  
TRIGger:SEquence2]:STOP:SOURCE

:STOP:SOURce|

---

## TRIGger:SEQuence2|:STOP:SOURce

$$\text{TRIGger:SEQuence2|:STOP:SOURce} \begin{cases} \text{IMMediate} \\ \text{EXTernal} \end{cases}$$

The “TRIGger:SEQuence2|:STOP:SOURce” command sets the pulse trigger stop source.

The parameters are as follows:

IMMediate      Sets the trigger stop source to immediate (no external trigger).

EXTernal        Sets the trigger stop source to external.

---

This command is used when setting the Signal Generator to Gated pulse mode. When the trigger stop source is set to external and the trigger source is also set to external using the “TRIGger[:SEQuence[1]]:START[:SOURce]” command, Gated pulse mode is chosen.

The preset value for pulse trigger stop source is immediate (no external pulse trigger).

### Query Syntax

TRIGger:SEQuence2|:STOP:SOURce?

Returned format:

*source*<NL>

Where:

- *source* ::= “IMM” if the pulse trigger stop source is currently set to immediate (no external pulse trigger).
- *source* ::= “EXT” if the pulse trigger stop source is currently set to external.

---

**Note**            This command is only valid when Option 1E2 is installed.

---

### See Also

Connectors  
[SOURce[1]]:PULM:SOURce  
[SOURce[1]]:PULM:STATe  
TRIGger[:SEQuence[1]]:START[:SOURce]



---

## [SOURce[1]:]POWer[:LEVel]

$$[\text{SOURce}[1]:]\text{POWer}[:\text{LEVel}][:\text{IMMediate}][:\text{AMPLitude}] \left\{ \begin{array}{l} \textit{ampl} \\ \text{MAXimum} \\ \text{MINimum} \\ \text{UP} \\ \text{DOWN} \\ \text{DEFault} \end{array} \right\}$$

The “[SOURce[1]:]POWer[:LEVel]” command sets the output power level of the Signal Generator.

The parameters are as follows:

|             |  |
|-------------|--|
| <i>ampl</i> | Sets the Signal Generator output power level. The allowable range for the parameter is –100 dBm to +30 dBm if option 1E1 is installed and –15 dBm to +30 dBm if option 1E1 is not installed. |
| MAXimum     | Sets the Signal Generator output power level to the maximum allowable value.   |
| MINimum     | Sets the Signal Generator output power level to the minimum allowable value.   |
| UP          | Increases the Signal Generator output power level by the current power level increment value.  |
| DOWN        | Decreases the Signal Generator output power level by the current power level increment value.  |
| DEFault     | Sets the Signal Generator output power level to its default (preset) value.  |

---

The allowable range for the *ampl* parameter is –100 dBm to +30 dBm if option 1E1 is installed and –15 dBm to +30 dBm if option 1E1 is not installed.

---

**Note** The actual maximum internally leveled output power for your instrument at a given frequency can be found by increasing the Signal Generator output power until the **UNLEVELED** LED lights.

---

If a power level entry is made that is not within the allowable parameter range, an error message will be generated and the parameter will be set to either its maximum or minimum limit. Power level resolution is 0.01 dB. The preset value is –90 dBm if option 1E1 is installed and 0 dBm if option 1E1 is not installed.

When the power level is modified, the Signal Generator circuitry will ensure that transitions from one power level to another will not allow the level to exceed the maximum of the two levels if the instrument is in CW mode (not modulated). If the RF output is being amplitude modulated or pulse modulated, the Signal Generator circuitry will ensure that transitions from one power level to another will not exceed the maximum of the two power levels by more than 0.5 dB typical.

---

**Note** Changing frequency or power level while pulse modulating the output triggers an internal power level calibration. This calibration includes a CW burst

for approximately 30 ms. Refer to the “[SOURCE[1]:]POWER:PROTECTION” command for information on how to protect devices sensitive to CW power.

---

Four options are available for leveling of the output power. These are internal leveling, external diode leveling, external power meter leveling, and the level correct routine. Refer to the “[SOURCE[1]:]POWER:ALC” command and level correct-related commands for information on the different leveling options.

## Query Syntax

[SOURCE[1]:]POWER[:LEVEL][:IMMEDIATE][:AMPLITUDE]? 

|         |
|---------|
| MAXimum |
| MINimum |
| DEFault |

Returned format:

*ampl*<NL>

Where:

- *ampl* ::= The current output power level if no argument is specified.
- *ampl* ::= The maximum output power level that can be set if the MAXimum argument is specified.
- *ampl* ::= The minimum output power level that can be set if the MINimum argument is specified.
- *ampl* ::= The default (preset) output power level if the DEFault argument is specified.

## See Also

[SOURCE[1]:]POWER:ALC:SOURce  
[SOURCE[1]:]POWER:PROTECTION:STATE  
[SOURCE[1]:]POWER[:LEVEL]:STEP  
UNIT:POWER|:VOLTage

---

## [SOURce[1]:]POWer[:LEVel]:STEP

```
[SOURce[1]:]POWer[:LEVel][:IMMediate][:AMPLitude]:STEP[:INCRement]
{
  incr
  MAXimum
  MINimum
  DEFault
}
```

The “[SOURce[1]:]POWer[:LEVel]:STEP” command selects the increment value for the Signal Generator output power level.

The parameters are as follows:

|             |   |
|-------------|---|
| <i>incr</i> | Sets the increment value for output power level. The allowable range for the parameter is 0.01 dB to 130 dB if option 1E1 is installed and 0.01 dB to 45 dB if option 1E1 is not installed. |
| MAXimum     | Sets the power level increment value to its maximum allowable value.  |
| MINimum     | Sets the power level increment value to its minimum allowable value.  |
| DEFault     | Sets the power level increment value to its default (preset) value.   |

---

When the “UP” or “DOWN” parameters are used with the “[SOURce[1]:]POWer[:LEVel]” command, the output power level will be increased or decreased by a step size set with the “[SOURce[1]:]POWer[:LEVel]:STEP” command.

Numeric power level increment value entries have a resolution 0.01 dB.

If a power level increment value entry is made that is not within the allowable parameter range, an error message will be generated and the parameter will be set to either its maximum or minimum limit. The preset value for the power level increment value is 1 dB.

### Query Syntax

```
[SOURce[1]:]POWer[:LEVel][:IMMediate][:AMPLitude]:STEP[:INCRement]?
[
  MAXimum
  MINimum
  DEFault
]
```

Returned format:

*incr*<NL>

Where:

- *incr* ::= The current power level increment value if no argument is specified.
- *incr* ::= The maximum power level increment value that can be set if the MAXimum argument is specified.
- *incr* ::= The minimum power level increment value that can be set if the MINimum argument is specified.
- *incr* ::= The default (preset) power level increment value if the DEFault argument is specified.



## See Also

[SOURce[1]:]POWer[:LEVel]  
UNIT:POWer|:VOLTage



---

## \*OPC (Operation Complete)

\*OPC

The “\*OPC” command sets bit 0 in the Standard Event Status register to one (1) when the Signal Generator has completed execution of all programming commands preceding it.

---

### Query Syntax

The “\*OPC?” query does not affect the Operation Complete bit in the Standard Event Status register.

\*OPC?

Returned format:

*number*<NL>

Where:

- *number* ::= “+1” when bit 0 in the Standard Event Status register has been set to one.

### See Also

\*ESE

\*ESR?

\*SRE

\*STB?

\*WAI

---

## SYSTem:COMMunicate:GPIB:ADDRess

SYSTem:COMMunicate:GPIB:ADDRess  $\left\{ \begin{array}{l} \textit{address} \\ \text{MAXimum} \\ \text{MINimum} \end{array} \right\}$

The “SYSTem:COMMunicate:GPIB:ADDRess” command allows you to change the Signal Generator HP-IB address.

The parameters are as follows:

*address*      The HP-IB address of the Signal Generator. The valid address range is 00 to 30 (decimal).

MAXimum      Sets the Signal Generator HP-IB address to its maximum allowable value.

MINimum      Sets the Signal Generator HP-IB address to its minimum allowable value.

---

The HP-IB address set at the factory is 19. Pressing the **INSTR PRESET** (**(-P)**) key or sending the \*RST or SYSTem:PRESet commands will not change the HP-IB address. When the HP-IB address is changed, the new address takes affect immediately.

## Query Syntax

SYSTem:COMMunicate:GPIB:ADDRess?  $\left[ \begin{array}{l} \text{MAXimum} \\ \text{MINimum} \end{array} \right]$

Returned format:

*address*<NL>

Where:

- *address* ::= The current HP-IB address of the Signal Generator when no optional argument is specified.
- *address* ::= The maximum allowable Signal Generator HP-IB address when the MAXimum argument is specified.
- *address* ::= The minimum allowable Signal Generator HP-IB address when the MINimum argument is specified.

## See Also

SYSTem:COMMunicate:GPIB:ADDRess:STEP

---

## SYSTem:COMMunicate:GPIB:ADDRess:STEP

SYSTem:COMMunicate:GPIB:ADDRess:STEP [ :INCRement ]  $\left\{ \begin{array}{l} incr \\ MAXimum \\ MINimum \\ DEFault \end{array} \right\}$

The “SYSTem:COMMunicate:GPIB:ADDRess:STEP” command selects the increment value for the Signal Generator HP-IB address.

The parameters are as follows:

|             |  |
|-------------|--|
| <i>incr</i> | Sets the increment value for the Signal Generator HP-IB address. The allowable range for the parameter is 1 to 30. |
| MAXimum     | Sets the HP-IB address increment value to its maximum allowable value.   |
| MINimum     | Sets the HP-IB address increment value to its minimum allowable value.   |
| DEFault     | Sets the HP-IB address increment value to its default (preset) value.  |

---

When the “UP” or “DOWN” parameters are used with the “SYSTem:COMMunicate:GPIB:ADDRess” command, the HP-IB address will be increased or decreased by a step size set with the “SYSTem:COMMunicate:GPIB:ADDRess:STEP” command.

If an HP-IB address increment value entry is made that is not within the allowable parameter range, an error message will be generated and the parameter will be set to either its maximum or minimum limit. The preset value for the HP-IB address increment value is 1.

### Query Syntax

SYSTem:COMMunicate:GPIB:ADDRess:STEP [ :INCRement ]?  $\left[ \begin{array}{l} MAXimum \\ MINimum \\ DEFault \end{array} \right]$

Returned format:

*incr*<NL>

Where:

- *incr* ::= The current HP-IB address increment value if no argument is specified.
- *incr* ::= The maximum HP-IB address increment value that can be set if the MAXimum argument is specified.
- *incr* ::= The minimum HP-IB address increment value that can be set if the MINimum argument is specified.
- *incr* ::= The default (preset) HP-IB address increment value if the DEFault argument is specified.

### See Also

SYSTem:COMMunicate:GPIB:ADDRess

---

## SYSTem:LANGUage

`SYSTem:LANGUage { "SCPI" }  
                  { "CIIL" }`

The “SYSTem:LANGUage” command sets the programming language that is accepted by the Signal Generator.

The parameters are as follows:

- “SCPI”           Sets the programming language to “SCPI” (Standard Commands for Programmable Instruments). This is the current industry standard and is the language documented in this manual.
- “CIIL”           Sets the programming language to “CIIL” (Control Interface Intermediate Language) if the CIIL programming language special order option is installed. Contact your HP representative for information on ordering the CIIL special order option.

---

The programming language set at the factory is SCPI. Pressing the **INSTR PRESET** (**I-P**) key or sending the \*RST or SYSTem:PRESet commands will not change the programming language.

### Query Syntax

`SYSTem:LANGUage?`

Returned format:

*lang*<NL>

Where:

- *lang* ::= “SCPI” if SCPI programming language is currently chosen.
- *lang* ::= “CIIL” if the CIIL programming language special order option is installed and the CIIL programming language is currently chosen.

---

## SYSTem:PTHRough[:STRing]

`SYSTem:PTHRough[:STRing] "!!string data!!"`

“SYSTem PTHRough[:STRing]” sends a command or a query, “string data”, to an MMS slave module.

The parameter is as follows:

*string data*     The command that is to be sent to the MMS slave.

---

The “string data” is sent to the address that is specified by the “SYST:PTHR:ADDR” command.

## Query Syntax

```
SYSTem:PTHRough[:STRing?]"
```

Returned format:

```
SYSTem:PTHRough[:STRing]"string data"
```

Where:

- *string data* ::= The current pass-through command

## See Also

```
SYSTem:PTHRough[STRing]
```

---

## SYSTem:PTHRough:ADDRESS

```
SYSTem:PTHRough:ADDRESS"!!string data!!"
```

“SYSTem PTHRough:ADDRESS” sets the pass-through slave address string.

The parameter is as follows:

*string data*      The address that is to be specified.

---

The “string data” preset value is “12;3”.

The following addresses are valid in this command:

| “string data” | Model Number |
|---------------|--------------|
| “PWR MTR”     | HP 70100A    |
| “FRQ DIV”     | HP 70341A    |
| “Signal Gen”  | HP 70340A    |

## Query Syntax

```
SYSTem:PTHRough:ADDRESS?
```

Returned format:

```
SYSTem:PTHRough:ADDRESSstring data
```

Where:

- *string data* ::= The current pass-through slave address string

## See Also

```
SYSTem:PTHRough[STRing]
```

---

## UNIT:FREQuency

UNIT:FREQuency { *freq suffix* }

The “UNIT:FREQuency” command determines the default suffix that will be assumed for the numeric argument of all frequency-related programming commands if no suffix is used. It also determines the units for the data that frequency-related queries return.

The parameter is as follows:

*freq suffix*      The default suffix to be assumed by all frequency-related programming commands when no suffix is used.

---

This command determines the default suffix that will be assumed for the numeric argument of all frequency-related programming commands when no suffix is used. The preset default suffix is hertz (HZ). For example, if you wanted to set the Signal Generator output frequency to 2.5 GHz with the default suffix being hertz (the preset value), you could send the following command:

```
OUTPUT 719; "FREQ 2500000000"
```

If you were to change the default suffix to gigahertz by sending the command “UNIT:FREQ GHZ”, the following command could be sent to set the Signal Generator output frequency to 2.5 GHz:

```
OUTPUT 719; "FREQ 2.5"
```

The available default suffixes appear in the following table. You will not likely want to use all of these default suffixes, but they are available.

**Available Default Suffixes**

| Default Suffix | Multiplication Factor |
|----------------|-----------------------|
| EXHZ           | $1 \times 10^{18}$    |
| PEHZ           | $1 \times 10^{15}$    |
| THZ            | $1 \times 10^{12}$    |
| GHZ            | $1 \times 10^9$       |
| MHZ            | $1 \times 10^6$       |
| KHZ            | $1 \times 10^3$       |
| HZ             | $1 \times 10^0$       |
| UHZ            | $1 \times 10^{-6}$    |
| NHZ            | $1 \times 10^{-9}$    |
| PHZ            | $1 \times 10^{-12}$   |
| FHZ            | $1 \times 10^{-15}$   |
| AHZ            | $1 \times 10^{-18}$   |

---

**Note**      There is no suffix for “ $1 \times 10^{-3}$ ” when working with the HZ suffix.

---



## Query Syntax

UNIT:FREQuency?

Returned format:

*freq suffix*<NL>

Where:

- *freq suffix* ::= The current default suffix for frequency-related programming commands and queries.

:VOLTage|

---

## UNIT:POWer|:VOLTage

UNIT:POWer|:VOLTage { *level suffix* }

The “UNIT:POWer|:VOLTage” command determines the default suffix that will be assumed for the numeric argument of all power level-related programming commands if no suffix is used. It also determines the units for the data that power level-related queries return.

The parameter is as follows:

*level suffix*      The default suffix to be assumed by all power level-related programming commands when no suffix is used.

---

This command determines the default suffix that will be assumed for the numeric argument of all power level-related programming commands when no suffix is used. The preset default suffix is dBm (DBM). For example, if you wanted to set the Signal Generator output power level to 13 dBm with the default suffix being dBm (the preset value), you could send the following command:

```
OUTPUT 719; "POW 13"
```

If you were to change the default suffix to milliwatts by sending the command “UNIT:POW MW”, the following command could be sent to set the Signal Generator output power level to 13 dBm.

```
OUTPUT 719; "POW 20"    20 mw is equal to 13 dBm.
```

There are several suffixes related to power level that can be used. These suffixes appear in the following table (“mult” can be left blank or replaced by the desired suffix multiplier, which is explained after the following table):

**Power Level-Related Suffixes**

| Suffix      | Description   |
|-------------|---------------|
| “mult” V    | Volts         |
| “mult” W    | Watts         |
| DB “mult” V | Decibel Volts |
| DB “mult” W | Decibel Watts |

The suffixes in the above table can include an optional suffix multiplier in place of “mult”. For example, the volts suffix “V” can be preceded by the suffix multiplier “M” to yield MV (millivolts) or  $1 \times 10^{-3}$  volts.

The available suffix multipliers appear in the following table. You will not likely want to use all of these suffix multipliers, but they are available.

### Available Suffix Multipliers

| Suffix Multiplier | Multiplication Factor |
|-------------------|-----------------------|
| EX                | $1 \times 10^{18}$    |
| PE                | $1 \times 10^{15}$    |
| T                 | $1 \times 10^{12}$    |
| G                 | $1 \times 10^9$       |
| MA                | $1 \times 10^6$       |
| K                 | $1 \times 10^3$       |
| M <sup>1</sup>    | $1 \times 10^{-3}$    |
| U                 | $1 \times 10^{-6}$    |
| N                 | $1 \times 10^{-9}$    |
| P                 | $1 \times 10^{-12}$   |
| F                 | $1 \times 10^{-15}$   |
| A                 | $1 \times 10^{-18}$   |

<sup>1</sup> The suffix “DBM” is equivalent to the suffix “DBMW.”

### Query Syntax

UNIT:POWer|:VOLTage?

Returned format:

*level suffix* <NL>

Where:

- *level suffix* ::= The current default suffix (including the suffix multiplier) for power level-related programming commands and queries.

---

## UNIT:TIME

UNIT:TIME { *time suffix* }

The “UNIT:TIME” command determines the default suffix that will be assumed for the numeric argument of all time-related programming commands if no suffix is used. It also determines the units for the data that time-related queries return.

The parameter is as follows:

*time suffix*      The default suffix to be assumed by all time-related programming commands when no suffix is used.

---

This command determines the default suffix that will be assumed for the numeric argument of all time-related programming commands when no suffix is used. The preset default suffix is seconds (S). For example, if you wanted to set pulse delay to 18  $\mu$ s with the default suffix being seconds (the preset value), you could send the following command:

```
OUTPUT 719; "PULS:DEL .000018"
```

If you were to change the default suffix to microseconds by sending the command “UNIT:TIME US”, the following command could be sent to set pulse delay to 18 $\mu$ s.

```
OUTPUT 719; "PULS:DEL 18"
```

The available default suffixes appear in the following table. You will not likely want to use all of these default suffixes, but they are available.

**Available Default Suffixes**

| Default Suffix | Multiplication Factor |
|----------------|-----------------------|
| EXS            | $1 \times 10^{18}$    |
| PES            | $1 \times 10^{15}$    |
| TS             | $1 \times 10^{12}$    |
| GS             | $1 \times 10^9$       |
| MAS            | $1 \times 10^6$       |
| KS             | $1 \times 10^3$       |
| S              | $1 \times 10^0$       |
| MS             | $1 \times 10^{-3}$    |
| US             | $1 \times 10^{-6}$    |
| NS             | $1 \times 10^{-9}$    |
| PS             | $1 \times 10^{-12}$   |
| FS             | $1 \times 10^{-15}$   |
| AS             | $1 \times 10^{-18}$   |

## Query Syntax

UNIT:TIME?

Returned format:

*time suffix*<NL>

Where:

- *time suffix* ::= The current default suffix for time-related programming commands and queries.

---

## **\*WAI (Wait-to-Continue Command)**

**\*WAI**

The “\*WAI” command makes the Signal Generator wait until pending operations have taken place, then continues executing commands that follow the “\*WAI” command.

---

The “\*WAI” command is useful when placed after those commands that are not necessarily finished executing before the next HP-IB command is executed when it is critical that they be finished executing. In general, SCPI commands execute sequentially but the “\*WAI” command can be used to allow the hardware to settle after a command is executed.

### **See Also**

\*OPC

---

## **OUTPut:PROTection[:STATe]**

$$\text{OUTPut:PROTection}[:\text{STATe}] \left\{ \begin{array}{l} \text{ON} \\ \text{OFF} \end{array} \right\}$$

The “OUTPut:PROTection[:STATe]” command turns RF protection during frequency switching on or off. This function is useful when measuring the Signal Generator frequency switching time.

The parameters are as follows:

ON                    Turns RF protection on during frequency switching.  
OFF                   Turns RF protection off during frequency switching.

---

The Signal Generator contains an RF protection circuit that momentarily attenuates output power and then brings the output power back up to the required level (in 20 ms nominal) when the Signal Generator output frequency is changed. This circuit assures that the output power does not overshoot the power level set via the front panel or HP-IB during frequency switching.

When the RF protection circuit is turned off, the Signal Generator will switch frequency faster, but the output power might overshoot during the frequency transition. The power overshoot can be as high as maximum power (as high as 25 dBm) attenuated by the current attenuator setting.

When the Signal Generator is set to the preset state, RF protection is turned on.

---

### **Notes**

1. RF protection during frequency switching can not be turned off when AM, FM, or pulse modulation is being used. It can only be turned off when the Signal Generator is in CW mode.
2. Even when the Signal Generator is in CW mode, and the RF protection during frequency switching function is turned off, the RF protection

circuit will switch in when the Signal Generator divider circuits switch or whenever frequency switches greater than 260 MHz occur.

---

## Query Syntax

```
OUTPut:PROTection[:STATe]?
```

Returned format:

```
state<NL>
```

Where:

- *state* ::= “+1” if RF protection during frequency switching is currently turned on.
- *state* ::= “+0” if RF protection during frequency switching is currently turned off.

## See Also

```
[SOURce[1]:]FREQuency[:CW|:FIXed]
```

---

## OUTPut[:STATe]

$$\text{OUTPut}[:\text{STATe}] \left\{ \begin{array}{l} \text{ON} \\ \text{OFF} \end{array} \right\}$$

The “OUTPut[:STATe]” command turns the signal at the **RF OUTPUT** connector on and off.

The parameters are as follows:

- |     |   |
|-----|---|
| ON  | Turns the signal at the <b>RF OUTPUT</b> connector on.  |
| OFF | Turns the signal at the <b>RF OUTPUT</b> connector off. |

---

When the “OUTP:STAT OFF” command is sent to the Signal Generator, the internal oscillators are turned off, and the internal RF power shutdown circuit is turned on. The preset state for the signal at the **RF OUTPUT** connector is on.

### Query Syntax

$$\text{OUTPut}[:\text{STATe}]?$$

Returned format:

*state*<NL>

Where:

- *state* ::= “+1” if the signal at the **RF OUTPUT** connector is currently turned on.
- *state* ::= “+0” if the signal at the **RF OUTPUT** connector is currently turned off.

### See Also

Connectors



---

## [SOURce[1]:]POWer:ATTenuation:AUTO

$$[\text{SOURce}[1]:]\text{POWer:ATTenuation:AUTO} \left\{ \begin{array}{l} \text{ON} \\ \text{OFF} \\ \text{ONCE} \end{array} \right\}$$

The “[SOURce[1]:]POWer:ATTenuation:AUTO” command turns the attenuator hold function on or off.

The parameters are as follows:

|      |   |
|------|---|
| ON   | Turns the attenuator hold function off.             |
| OFF  | Turns the attenuator hold function on.              |
| ONCE | Turns the attenuator hold function off and then on. |

---

The attenuator hold function can be used to extend the vernier range to prevent the step attenuator from switching between two levels. Locking the step attenuator keeps the attenuator from switching between the two levels as leveled power is varied above and below the threshold level, thus saving wear on the attenuator. Refer to the specification table for the Attenuator Switch Point Threshold.

When the “ONCE” parameter is used, the attenuator hold function is temporarily turned off so that the Signal Generator can automatically update the attenuator setting, then turned on to lock the attenuator at that setting.

### Advantages

Locking the step attenuator prevents switching between two levels when the leveled output power is set near an attenuator switching threshold. This is useful when using external leveling.

### Disadvantages

When the step attenuator is locked, the output power dynamic range is limited to the vernier range at the current output frequency. The vernier range extends from a lower limit that is typically 5 dB lower than the specified value for that range to an upper limit that is frequency dependent on the Signal Generator output frequency.

---

**Note** In external diode detector leveling or external power meter leveling mode, the attenuator is always locked in the current range and can not be unlocked using this function.

---

## Query Syntax

```
[SOURce[1]:]POWer:ATTenuation:AUTO?
```

Returned format:

```
state<NL>
```

Where:

- *state* ::= “+1” if the attenuator hold function is currently off or “+0” if the attenuator hold function is currently on or set to “once”.

## See Also

```
[SOURce[1]:]POWer[:LEVel]
```

---

## [SOURce[1]:]POWer:PROTection:STATe

$$[\text{SOURce}[1]:]\text{POWer:PROTection:STATe} \begin{cases} \text{ON} \\ \text{OFF} \end{cases}$$

The “[SOURce[1]:]POWer:PROTection:STATe” command turns the average power inhibit function on or off.

The parameters are as follows:

ON                    Turns the average power inhibit function on.

OFF                   Turns the average power inhibit function off.

---

When the Signal Generator is set to the preset state, the average power inhibit function is turned off.

The average power inhibit function can be used during pulse modulation to protect devices sensitive to high average power. When the output power level or frequency of the Signal Generator is changed during pulse modulation, the internal leveling algorithm causes the RF output to be momentarily switched to CW to enable the Signal Generator circuitry to sample the signal level and make a correction. If the output of the Signal Generator is connected to circuitry that is average power-sensitive, damage to the circuitry could result during this CW burst. When in internal leveling mode, the CW burst is approximately 30 ms.

When the average power inhibit function is off (the preset condition), the CW burst will accompany output power level and frequency changes. The CW burst will also be present the first time pulse or logarithmic amplitude modulation is enabled. When average power inhibit is on, the internal step attenuator will switch in 90 dB of attenuation during the CW burst. This will protect power-sensitive circuitry connected to the **RF OUTPUT** connector, but will cause extra wear on the step attenuator . Turning the function on will also cause a momentary drop in signal power (nominally 200 ms) and will lengthen frequency and power level switching times to 200 ms.

### Query Syntax

$$[\text{SOURce}[1]:]\text{POWer:PROTection:STATe?}$$

Returned format:

*state*<NL>

Where:

- *state* ::= “+1” if the average power inhibit function is currently on or “+0” if the average power inhibit function is currently off.

### See Also

[SOURce[1]:]POWer[:]LEVel  
[SOURce[1]:]PULM:SOURce  
[SOURce[1]:]PULM:STATe



## The Status Register System

You can find out the state of certain instrument hardware and firmware events and conditions by programming the status register system. The status register system is arranged in a hierarchical order. Three lower status groups provide information to the status byte group. The status byte group is used to determine the general nature of an event and the lower status groups are used to determine the specific nature of the event. A **status group** is a set of related registers whose contents are programmed in order to produce status summary bits. The hierarchy of the status register system is shown in Figure 7-1.

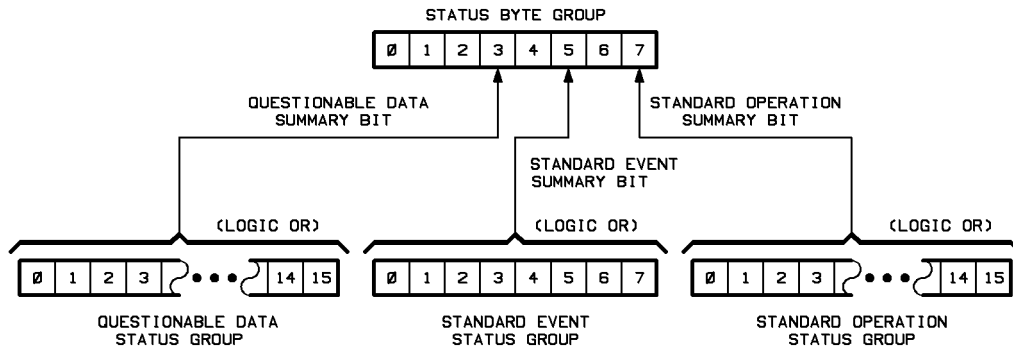

Figure 7-1. Status Register System Hierarchy

## General Status Group Model

Figure 7-2 shows the structure of a typical status group. Corresponding bits in the Condition Register are filtered by the Negative and Positive Transition Registers and stored in the Event Register. The contents of the Event Register are logically ANDed with the contents of the Enable Register and the result is logically ORed to produce a status summary bit.

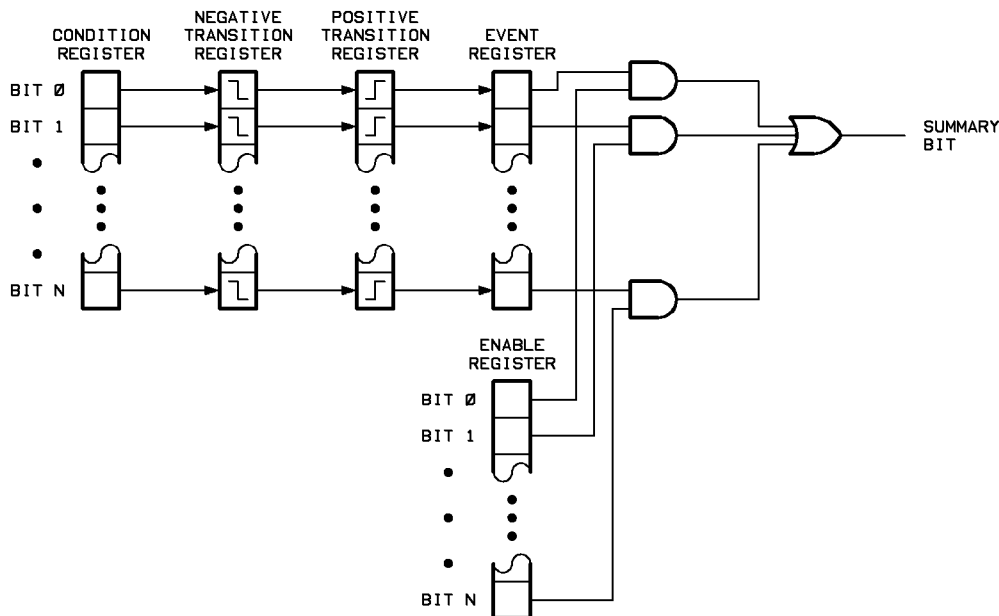

Figure 7-2. General Status Group Model

Note that each status group does not necessarily contain all of the registers shown in Figure 7-2. For example, the Standard Event status group only contains an Event Register and an Enable Register. Each of the Signal Generator status groups consists of some or all of the registers explained below:

### **Condition Register**

A condition register continuously monitors the hardware and firmware status of the Signal Generator. There is no latching or buffering for a condition register; it is updated in real time.

### **Negative Transition Register**

A negative transition register specifies the bits in the condition register that will set corresponding bits in the event register when the condition bit changes from 1 to 0.

### **Positive Transition Register**

A positive transition register specifies the bits in the condition register that will set corresponding bits in the event register when the condition bit changes from 0 to 1.

### **Event Register**

An event register latches transition events from the condition register as specified by the positive and negative transition registers. Bits in the event register are latched, and once set, they remain set until cleared by either querying the register contents or sending the “\*CLS” command.

### **Enable Register**

An enable register specifies the bits in the event register that can generate a summary bit. The Signal Generator logically ANDs corresponding bits in the event and enable registers, and ORs all the resulting bits to produce a summary bit. Summary bits are, in turn, used by the Status Byte group.

## **Signal Generator Status Groups**

The Signal Generator status register system consists of the Status Byte group and three other status groups that provide input to the Status Byte group. The following paragraphs explain the information that is provided by each status group.

### **The Status Byte Group**

The Status Byte group is used to determine the general nature of an instrument event or condition. The Status Byte group consists of the Service Request Enable register and the Status Byte. The bits in the Status Byte provide you with the following information:

| <b>Bit</b> | <b>Description</b>   |
|------------|--|
| 0 - 2      | These bits are always set to 0.  |
| 3          | A 1 in this bit position indicates that the Questionable Data summary bit has been set. The Questionable Event register can then be read to determine the specific condition that caused this bit to be set. |

- 4 A 1 in this bit position indicates that the Signal Generator has data ready in its output queue. Note that there are no lower status groups that provide input to this bit.
- 5 A 1 in this bit position indicates that the Standard Event summary bit has been set. The Standard Event Status register can then be read to determine the specific event that caused this bit to be set.
- 6 A 1 in this bit position indicates that the instrument has at least one reason to require service. The bits in the Status Byte are logically ANDed with the Service Request Enable register and the result is ORed and input to this bit.
- 7 A 1 in this bit position indicates that the Standard Operation summary bit has been set. The Operation Event register can then be read to determine the specific condition that caused this bit to be set.

### The Standard Event Status Group

The Standard Event Status group is used to determine the specific event that set bit 5 in the Status Byte. The Standard Event Status group consists of the Standard Event Status register (an Event register) and the Standard Event Status Enable register. The bits in the Standard Event Status register provide you with the following information:

| Bit | Description   |
|-----|---|
| 0   | A one in this bit position indicates that all pending Signal Generator operations were completed following execution of the “*OPC” command.                                     |
| 1   | This bit is always set to 0.  |
| 2   | A one in this bit position indicates that a query error has occurred. Query errors have SCPI error numbers from -499 to -400.   |
| 3   | A one in this bit position indicates that a device dependent error has occurred. Device dependent errors have SCPI error numbers from -399 to -300 and 1 to 32767.              |
| 4   | A one in this bit position indicates that an execution error has occurred. Execution errors have SCPI error numbers from -299 to -200.  |
| 5   | A one in this bit position indicates that a command error has occurred. Command errors have SCPI error numbers from -199 to -100.   |
| 6   | A one in this bit position indicates that at least one front panel key (except the LINE switch) has been pressed (even if the Signal Generator is in Local Lockout (LLO) mode). |
| 7   | A one in this bit position indicates that the Signal Generator has been turned off and then on.   |

### The Standard Operation Status Group

The Standard Operation status group is used to determine the specific condition that set bit 7 in the Status Byte. The Standard Operation status group consists of the Operation Condition register, Operation Negative Transition register, Operation Positive Transition register, Operation Event register, and Operation Event Enable register. The bits in the Operation Event register provide you with the following information:

| <b>Bit</b> | <b>Description</b>  |
|------------|---|
| 0          | A one in this bit position indicates that the YIG oscillator calibration is currently being run.                                |
| 1          | A one in this bit position indicates that the Signal Generator hardware is settling (for example, the power level is changing). |
| 2 - 6      | These bits are always set to 0.   |
| 7          | A one in this bit position indicates that the Signal Generator level correct routine is being run.                              |
| 8 - 15     | These bits are always set to 0.   |

### The Questionable Data Status Group

The Questionable Data status group is used to determine the specific condition that set bit 3 in the Status Byte. The Questionable Data status group consists of the Questionable Condition register, Questionable Negative Transition register, Questionable Positive Transition register, Questionable Event register, and Questionable Event Enable register. The bits in the Questionable Event register provide you with the following information:

| <b>Bit</b> | <b>Description</b>  |
|------------|---|
| 0 - 2      | These bits are always set to 0.   |
| 3          | A one in this bit position indicates that the RF output power might be uncalibrated or unleveled.   |
| 4          | A one in this bit position indicates that the internal frequency reference oven is cold (option 1E5 only).  |
| 5          | A one in this bit position indicates that the Signal Generator output frequency might be uncalibrated. This bit is set if the signal is out of lock, uncalibrated, or the oven is cold. |
| 6          | This bit is always set to 0.  |
| 7          | A one in this bit position indicates that one or more of the modulations might be uncalibrated.   |
| 8          | This bit is set to 1 whenever bits 3, 5, or 7 in this register are set to 1. This bit is set if frequency power or modulation is uncalibrated.  |
| 9 - 15     | These bits are always set to 0.   |

### Status Register System Programming Example

In the following example, the Status Register System is programmed to set bit 6 of the status byte (the SRQ bit) high after the Signal Generator hardware has settled. Bit 6 is monitored and, once it is set high, the controller prints "HARDWARE IS SETTLED" on its screen.

|                                  |  |
|----------------------------------|--|
| 10 OUTPUT 719;"STAT:OPER:PTR 0"  | <i>Disable all bits in the Operation Positive Transition register.</i>                           |
| 20 OUTPUT 719;"STAT:OPER:NTR 2"  | <i>Enable bit 2 (the "hardware settling" bit) in the Operation Negative Transition register.</i> |
| 30 OUTPUT 719;"STAT:OPER:ENAB 2" | <i>Enable bit 2 (the "hardware settling" bit) in the Operation Event Enable register.</i>        |



40 OUTPUT 719;"\*SRE 128"

*Enable bit 7 (the OPErAtion summary bit) in the Service Request Enable register to cause an SRQ.*

50 PRINT "SRQ IS SET UP"

*Clear any previous status conditions.*

60 OUTPUT 719;"\*CLS"

*Clear old SRQ state.*

70 A=SPOLL(719)

*Set Signal Generator output frequency and power.*

80 OUTPUT 719;"FREQ 2.123GHz;POW -1.23dBm"

*Poll the SRQ state.*

90 Wait4srq: A=SPOLL(719)

*If no SRQ has been generated, keep polling.*

100 IF A=0 THEN GOTO Wait4srq

110 PRINT "HARDWARE IS SETTLED"

120 END

---

## **\*CLS (Clear Status Command)**

**\*CLS**

The “\*CLS” command clears the Operation Event register, Questionable Event register, and the Standard Status Event register. It also clears the front panel error queue.

---

Sending the “\*CLS” command sets all bits in the Operation Event register, Questionable Event register, and the Standard Status Event register to 0. Clearing these registers causes bits 3, 5, and 7 in the Status Byte register to be temporarily set to 0. The “\*CLS” command also clears the HP-IB error reporting queue and the Request-for-OPC flag.

If the \*CLS command immediately follows a PROGRAM MESSAGE TERMINATOR, the output queue and the MAV bit will also be cleared.

The \*CLS command does not clear data memories or any instrument settings.

### **See Also**

\*ESR?  
STATus:OPERation[:EVENT]?  
STATus:QUEStionable[:EVENT]?  
\*STB?

---

## \*ESE (Standard Event Status Enable)

\*ESE *number*

The “\*ESE” command sets the Standard Event Status Enable register. This register selects which bits in the Standard Event Status Register can set bit 5 in the status byte.

The parameter is as follows:

*number*            The number representing the value of bits in the Standard Event Status Enable register to be set. *number* can be from 0 to 255.

---

Bits in the Standard Event Status Enable register are logically ANDed with bits in the Standard Event Status register. If the result is 1, bit 5 in the status byte is set.

The decimal value of each bit in the Standard Event Status Enable register is shown in the following table.

**Standard Event Status Enable Register Bit Definitions**

| Bit | Weight | Enables                                |
|-----|--------|--|
| 7   | 128    | PON - Power on occurred.               |
| 6   | 64     | URQ - User request (key pressed).      |
| 5   | 32     | CME - Command error occurred.          |
| 4   | 16     | EXE - Execution error occurred.        |
| 3   | 8      | DDE - Device dependent error occurred. |
| 2   | 4      | QYE - Query error occurred.            |
| 1   | 2      | RQC - Request control (not used).      |
| 0   | 1      | OPC - Operation complete.              |

On power on, the Standard Event Status Enable register is set to 0 unless the \*PSC command has been set to zero (0).

### Query Syntax

\*ESE?

Returned format:

*number*<NL>

Where:

- *number* ::= The current value of the Standard Event Status Enable register.

## **See Also**

- \*CLS
- \*ESR?
- \*OPC
- \*PSC
- \*SRE
- \*STB?

---

## \*ESR? (Standard Event Status Register Query)

\*ESR?

The “\*ESR?” query returns the contents of the Standard Event Status register.

---

When you read the contents of the Event Status register, the value returned is the total bit weights of all the bits that are high at the time you read it.

The decimal value of each bit (the bit weight) in the Event Status register is shown in the following table.

**Event Status Register Bit Definitions**

| Bit | Weight | Name | Condition  |
|-----|--------|------|--|
| 7   | 128    | PON  | 0 = no OFF to ON transition has occurred with the Signal Generator power.<br>1 = an OFF to ON transition has occurred with the Signal Generator power. |
| 6   | 64     | URQ  | 0 = no front panel key has been pressed.<br>1 = front panel key has been pressed.  |
| 5   | 32     | CME  | 0 = no command errors have been detected.<br>1 = a command error has been detected.  |
| 4   | 16     | EXE  | 0 = no execution error has been detected.<br>1 = an execution error has been detected.   |
| 3   | 8      | DDE  | 0 = no device dependent errors have been detected.<br>1 = a device dependent error has been detected.  |
| 2   | 4      | QYE  | 0 = no query errors have been detected.<br>1 = a query error has been detected.  |
| 1   | 2      | RQC  | Not used - always 0.   |
| 0   | 1      | OPC  | 0 = operation is not complete.<br>1 = operation is complete.   |

The Event Status register is cleared (set to 0) when the “\*CLS” command is sent or after “\*ESR?” is executed.

When an error is reported to the HP-IB error queue, one of the Standard Event Status Register’s error bits is also set. Which bit is set depends upon the value of the Manual Error Number. If the Manual Error Number is from –199 to –100, the Command Error bit is set. If the Manual Error Number is from –299 to –200, the Execution Error bit is set. If the Manual Error Number is from –399 to –300 or from 1 to 32767, the Device Dependent Error bit is set. If the Manual Error Number is from –499 to –400, the Query Error bit is set.

---

**Note** Error messages related to hardware failures are listed in the HP 70340A Service Guide (HP part number 70340-90007).

---

## **See Also**

- \*CLS
- \*ESE
- \*OPC
- \*SRE
- \*STB?

---

## \*PSC (Power-On Status Clear)

$$*PSC \begin{cases} 0 \\ 1 \end{cases}$$

The “\*PSC” command enables or disables the automatic power-on clearing of the Service Request Enable (\*SRE) register and the Standard Event Status Enable (\*ESE) register. It also enables or disables the automatic power-on presetting of the SCPI STATUS transition registers and enable registers.

The parameters are as follows:

- |   |   |
|---|---|
| 0 | Disables clearing of Service Request Enable (*SRE) register and Standard Event Status Enable (*ESE) register at power up as well as power-on presetting of the SCPI STATUS transition registers and enable registers. |
| 1 | Enables clearing of Service Request Enable (*SRE) register and Standard Event Status Enable (*ESE) register at power up as well as power-on presetting of the SCPI STATUS transition registers and enable registers.  |

---

The factory preset condition for the “\*PSC” command is “1” (clearing enabled). Once the \*PSC value is changed, it is not affected by pressing the **INSTR PRESET** (**I-P**) key or sending the “\*RST” or “SYST:PRES” commands.

### Query Syntax

\*PSC?

Returned format:

*state*<NL>

Where:

- *state* ::= “+0” if clearing of the \*SRE and \*ESE registers at power-up is disabled or “+1” if clearing of the \*SRE and \*ESE registers at power-up is enabled.

### See Also

\*ESE

\*SRE

---

## \*SRE (Service Request Enable)

*\*SRE number*

The “\*SRE” command sets the Service Request Enable register bits.

The parameter is as follows:

*number*            The number representing the value of bits in the Service Request Enable register to be set. *number* can be from 0 to 191.

---

The Service Request Enable register contains a mask value for the bits to be enabled to produce an SRQ in the status byte. A one (1) in the Service Request Enable register will enable the corresponding bit in the status byte. A zero (0) will disable the bit.

The decimal value of each bit in the Service Request Enable register is shown in the following table.

**Service Request Enable Register Bit Definitions**

| Bit | Weight | Enables                        |
|-----|--------|--------------------------------|
| 7   | 128    | SCPI operation summary bit.    |
| 6   | 64     | Cannot be set.                 |
| 5   | 32     | ESB - Event Status Bit.        |
| 4   | 16     | MAV - Message Available.       |
| 3   | 8      | SCPI questionable summary bit. |
| 2   | 4      | Don't care.                    |
| 1   | 2      | Don't care.                    |
| 0   | 1      | Don't care.                    |

On power on, the Service Request Enable register is set to 0 unless the \*PSC command has been set to zero (0).

### Query Syntax

*\*SRE?*

Returned format:

*number* <NL>

Where:

- *number* ::= The current value of the Service Request Enable register.

### See Also

\*ESE  
\*ESR?  
\*PSC  
\*STB?



---

## STATus:OPERation:CONDition?

STATus:OPERation:CONDition?

The “STATus:OPERation:CONDition?” query returns the contents of the Operation Condition register.

---

The Operation Condition register is constantly updated as operational conditions occur. No conditions are saved in this register.

When you read the contents of the Operation Condition register, the value returned is the total bit weights of all the bits that are high at the time you read it. When you read the contents of the Operation Condition register using this command, the contents of the register are not altered.

The decimal value of each bit (the bit weight) in the Operation Condition register is shown in the following table.

**Operation Condition Register Bit Definitions**

| Bit | Weight | Condition  |
|-----|--------|--|
| 15  | 32768  | Not used - always 0.   |
| 14  | 16384  | Not used - always 0.   |
| 13  | 8192   | Not used - always 0.   |
| 12  | 4096   | Not used - always 0.   |
| 11  | 2048   | Not used - always 0.   |
| 10  | 1024   | Not used - always 0.   |
| 9   | 512    | Not used - always 0.   |
| 8   | 256    | Not used - always 0.   |
| 7   | 128    | 0 = instrument is not level correcting.<br>1 = instrument is level correcting. |
| 6   | 64     | Not used - always 0.   |
| 5   | 32     | Not used - always 0.   |
| 4   | 16     | Not used - always 0.   |
| 3   | 8      | Not used - always 0.   |
| 2   | 4      | Not used - always 0.   |
| 1   | 2      | 0 = instrument is not settling.<br>1 = instrument is settling.                 |
| 0   | 1      | 0 = instrument is not calibrating.<br>1 = instrument is calibrating.           |

### See Also

STATus:OPERation[:EVENT]?  
STATus:OPERation:ENABLE  
STATus:OPERation:PTRansition  
STATus:OPERation:NTRansition  
\*STB?

---

## STATUS:OPERation:ENABLE

STATUS:OPERation:ENABLE *number*

The “STATUS:OPERation:ENABLE” command sets the contents of the Operation Event Enable register.

The parameter is as follows:

*number*            The number representing the value of bits in the Operation Event Enable register to be set. The number must be from 0 to 32767.

---

The Operation Event Enable register contains a mask value for the bits to be enabled to set bit 7 in the status byte. A one (1) in the Operation Event Enable register will enable the corresponding bit in the Operation Event register to set bit 7 in the status byte. A zero (0) will disable the bit.

The decimal value of each bit (the bit weight) in the Operation Event Enable register is shown in the following table.

**Operation Event Enable Register Bit Definitions**

| Bit | Weight | Condition   |
|-----|--------|---|
| 15  | 32768  | can't set.  |
| 14  | 16384  | X - don't care.   |
| 13  | 8192   | X - don't care.   |
| 12  | 4096   | X - don't care.   |
| 11  | 2048   | X - don't care.   |
| 10  | 1024   | X - don't care.   |
| 9   | 512    | X - don't care.   |
| 8   | 256    | X - don't care.   |
| 7   | 128    | 0 = inhibit a “level correcting” event from setting bit 7 in the status byte.<br>1 = enable a “level correcting” event to set bit 7 in the status byte. |
| 6   | 64     | X - don't care.   |
| 5   | 32     | X - don't care.   |
| 4   | 16     | X - don't care.   |
| 3   | 8      | X - don't care.   |
| 2   | 4      | X - don't care.   |
| 1   | 2      | 0 = inhibit a “settling” event from setting bit 7 in the status byte.<br>1 = enable a “settling” event to set bit 7 in the status byte.                 |
| 0   | 1      | 0 = inhibit a “calibrating” event from setting bit 7 in the status byte.<br>1 = enable a “calibrating” event to set bit 7 in the status byte.           |

## Query Syntax

STATus:OPERation:ENABle?

Returned format:

*number*<NL>

Where:

- *number* ::= The current value of the Operation Event Enable register.

## See Also

STATus:OPERation[:EVENT]?

STATus:OPERation:CONDition?

STATus:OPERation:PTRansition

STATus:OPERation:NTRansition

\*STB?

---

## STATus:OPERation[:EVENT]?

STATus:OPERation[:EVENT]?

The “STATus:OPERation[:EVENT]?” query returns the contents of the Operation Event register.

---

The Operation Event register holds a record of the state changes in the Operation Condition register that were defined in the Operation Edge Registers.

When you read the contents of the Operation Event register, the value returned is the total bit weights of all the bits that are high at the time you read it. When you read the contents of the Operation Event register using this command, the register is cleared (set to zero).

The decimal value of each bit (the bit weight) in the Operation Event register is shown in the following table.

### Operation Event Register Bit Definitions

| Bit | Weight | Condition  |
|-----|--------|--|
| 15  | 32768  | Not used - always 0.   |
| 14  | 16384  | Not used - always 0.   |
| 13  | 8192   | Not used - always 0.   |
| 12  | 4096   | Not used - always 0.   |
| 11  | 2048   | Not used - always 0.   |
| 10  | 1024   | Not used - always 0.   |
| 9   | 512    | Not used - always 0.   |
| 8   | 256    | Not used - always 0.   |
| 7   | 128    | 0 = a “level correcting” event has not occurred in the Operation Condition register that is defined by the Operation Edge registers.<br>1 = a “level correcting” event has occurred in the Operation Condition register that is defined by the Operation Edge registers. |
| 6   | 64     | Not used - always 0.   |
| 5   | 32     | Not used - always 0.   |
| 4   | 16     | Not used - always 0.   |
| 3   | 8      | Not used - always 0.   |
| 2   | 4      | Not used - always 0.   |
| 1   | 2      | 0 = a “settling” event has not occurred in the Operation Condition register that is defined by the Operation Edge registers.<br>1 = a “settling” event has occurred in the Operation Condition register that is defined by the Operation Edge registers.                 |
| 0   | 1      | 0 = a “calibrating” event has not occurred in the Operation Condition register that is defined by the Operation Edge registers.<br>1 = a “calibrating” event has occurred in the Operation Condition register that is defined by the Operation Edge registers.           |

The Operation Event register is also set to zero (0) after the “\*CLS” command is sent.

#### See Also

STATus:OPERation:CONDition?  
 STATus:OPERation:ENABLE  
 STATus:OPERation:PTRansition  
 STATus:OPERation:NTRansition  
 \*STB?

## STATUS:OPERation:NTRansition

STATUS:OPERation:NTRansition *number*

The “STATUS:OPERation:NTRansition” command is used to define which bits in the Operation Condition register will set the corresponding bit in the Operation Event register on a one to zero state change.

The parameter is as follows:

*number*            The number representing the value of bits in the Operation Negative Transition register to be set. The number must be from 0 to 32767.

The decimal value of each bit (the bit weight) in the Operation Negative Transition register is shown in the following table.

**Operation Negative Transition Register Bit Definitions**

| Bit | Weight | Condition   |
|-----|--------|---|
| 15  | 32768  | can't set.  |
| 14  | 16384  | X - don't care.   |
| 13  | 8192   | X - don't care.   |
| 12  | 4096   | X - don't care.   |
| 11  | 2048   | X - don't care.   |
| 10  | 1024   | X - don't care.   |
| 9   | 512    | X - don't care.   |
| 8   | 256    | X - don't care.   |
| 7   | 128    | 0 = inhibit a one to zero state change of the “level correcting” bit from setting bit 7 in the Operation Event register.<br>1 = enable a one to zero state change of the “level correcting” bit to set bit 7 in the Operation Event register. |
| 6   | 64     | X - don't care.   |
| 5   | 32     | X - don't care.   |
| 4   | 16     | X - don't care.   |
| 3   | 8      | X - don't care.   |
| 2   | 4      | X - don't care.   |
| 1   | 2      | 0 = inhibit a one to zero state change of the “settling” bit from setting bit 1 in the Operation Event register.<br>1 = enable a one to zero state change of the “settling” bit to set bit 1 in the Operation Event register.                 |
| 0   | 1      | 0 = inhibit a one to zero state change of the “calibrating” bit from setting bit 0 in the Operation Event register.<br>1 = enable a one to zero state change of the “calibrating” bit to set bit 0 in the Operation Event register.           |

## Query Syntax

STATUS:OPERation:NTRansition?

Returned format:

*number*<NL>

Where:

- *number* ::= The current value of the Operation Negative Transition register.

## See Also

STATUS:OPERation[:EVENT]?

STATUS:OPERation:CONDition?

STATUS:OPERation:ENABle

STATUS:OPERation:PTRansition

\*STB?

---

## STATUS:OPERation:PTRansition

STATUS:OPERation:PTRansition *number*

The “STATUS:OPERation:PTRansition” command is used to define which bits in the Operation Condition register will set the corresponding bit in the Operation Event register on a zero to one state change.

The parameter is as follows:

*number*            The number representing the value of bits in the Operation Positive Transition register to be set. The number must be from 0 to 32767.

---

The decimal value of each bit (the bit weight) in the Operation Positive Transition register is shown in the following table.

**Operation Positive Transition Register Bit Definitions**

| Bit | Weight | Condition   |
|-----|--------|---|
| 15  | 32768  | can't set.  |
| 14  | 16384  | X - don't care.   |
| 13  | 8192   | X - don't care.   |
| 12  | 4096   | X - don't care.   |
| 11  | 2048   | X - don't care.   |
| 10  | 1024   | X - don't care.   |
| 9   | 512    | X - don't care.   |
| 8   | 256    | X - don't care.   |
| 7   | 128    | 0 = inhibit a zero to one state change of the “level correcting” bit from setting bit 7 in the Operation Event register.<br>1 = enable a zero to one state change of the “level correcting” bit to set bit 7 in the Operation Event register. |
| 6   | 64     | X - don't care.   |
| 5   | 32     | X - don't care.   |
| 4   | 16     | X - don't care.   |
| 3   | 8      | X - don't care.   |
| 2   | 4      | X - don't care.   |
| 1   | 2      | 0 = inhibit a zero to one state change of the “settling” bit from setting bit 1 in the Operation Event register.<br>1 = enable a zero to one state change of the “settling” bit to set bit 1 in the Operation Event register.                 |
| 0   | 1      | 0 = inhibit a zero to one state change of the “calibrating” bit from setting bit 0 in the Operation Event register.<br>1 = enable a zero to one state change of the “calibrating” bit to set bit 0 in the Operation Event register.           |



## Query Syntax

STATUS:OPERation:PTRansition?

Returned format:

*number*<NL>

Where:

- *number* ::= The current value of the Operation Positive Transition register.

## See Also

STATUS:OPERation[:EVENT]?

STATUS:OPERation:CONDition?

STATUS:OPERation:ENABle

STATUS:OPERation:NTRansition

\*STB?

---

## STATus:PRESet

STATus:PRESet

The “STATus:PRESet” command sets the following status registers to a known state:

- Operation Event Enable register
- Operation Negative Transition register
- Operation Positive Transition register
- Questionable Event Enable register
- Questionable Negative Transition register
- Questionable Positive Transition register

---

When the “STATus:PRESet” command is sent, the status registers are affected as shown in the following table.

**Status Register Preset Conditions**

| Register                                  | Preset Value |
|---|--------------|
| Operation Event Enable register           | 0            |
| Operation Negative Transition register    | 0            |
| Operation Positive Transition register    | 32767        |
| Questionable Event Enable register        | 0            |
| Questionable Negative Transition register | 0            |
| Questionable Positive Transition register | 32767        |

### See Also

- STATus:OPERation[:EVENT]?
- STATus:OPERation:CONDition?
- STATus:OPERation:ENABLE
- STATus:OPERation:NTRansition
- STATus:OPERation:PTRansition
- STATus:QUEStionable[:EVENT]?
- STATus:QUEStionable:CONDition?
- STATus:QUEStionable:ENABLE
- STATus:QUEStionable:NTRansition
- STATus:QUEStionable:PTRansition
- \*STB?

---

## STATus:QUEStionable:CONDition?

STATus:QUEStionable:CONDition?

The “STATus:QUEStionable:CONDition?” query returns the contents of the Questionable Condition register.

---

The Questionable Condition register is constantly updated as questionable conditions change. No conditions are saved in this register.

When you read the contents of the Questionable Condition register, the value returned is the total bit weights of all the bits that are high at the time you read it. When you read the contents of the Questionable Condition register using this command, the contents of the register are not altered.

The decimal value of each bit (the bit weight) in the Questionable Condition register is shown in the following table.

**Questionable Condition Register Bit Definitions**

| Bit | Weight | Condition  |
|-----|--------|--|
| 15  | 32768  | Not used - always 0.   |
| 14  | 16384  | Not used - always 0.   |
| 13  | 8192   | Not used - always 0.   |
| 12  | 4096   | Not used - always 0.   |
| 11  | 2048   | Not used - always 0.   |
| 10  | 1024   | Not used - always 0.   |
| 9   | 512    | Not used - always 0.   |
| 8   | 256    | 0 = instrument is calibrated.<br>1 = instrument is un-calibrated.  |
| 7   | 128    | 0 = modulation circuitry is calibrated.<br>1 = modulation circuitry is un-calibrated.                                      |
| 6   | 64     | Not used - always 0.   |
| 5   | 32     | 0 = frequency circuitry is locked.<br>1 = frequency circuitry is unlocked.   |
| 4   | 16     | 0 = internal frequency reference oven has reached operating temperature.<br>1 = internal frequency reference oven is cold. |
| 3   | 8      | 0 = output power is calibrated or leveled.<br>1 = output power is un-calibrated or unlevelled.                             |
| 2   | 4      | Not used - always 0.   |
| 1   | 2      | Not used - always 0.   |
| 0   | 1      | Not used - always 0.   |

## See Also

STATUS:QUESTIONABLE[:EVENT]?  
STATUS:QUESTIONABLE:ENABLE  
STATUS:QUESTIONABLE:PTRANSITION  
STATUS:QUESTIONABLE:NTRANSITION  
\*STB?

---

## STATUS:QUESTIONABLE:ENABLE

STATUS:QUESTIONABLE:ENABLE *number*

The “STATUS:QUESTIONABLE:ENABLE” command sets the contents of the Questionable Event Enable register.

The parameter is as follows:

*number*            The number representing the value of bits in the Questionable Event Enable register to be set. The number must be from 0 to 32767.

---

The Questionable Event Enable register contains a mask value for the bits to be enabled to set bit 3 in the status byte. A one (1) in the Questionable Event Enable register will enable the corresponding bit in the Questionable Event register to set bit 3 in the status byte. A zero (0) will disable the bit.

The decimal value of each bit (the bit weight) in the Questionable Event Enable register is shown in the following table.

### Questionable Event Enable Register Bit Definitions

| Bit | Weight | Condition   |
|-----|--------|---|
| 15  | 32768  | can't set.  |
| 14  | 16384  | X - don't care.   |
| 13  | 8192   | X - don't care.   |
| 12  | 4096   | X - don't care.   |
| 11  | 2048   | X - don't care.   |
| 10  | 1024   | X - don't care.   |
| 9   | 512    | X - don't care.   |
| 8   | 256    | 0 = inhibit an "instrument calibration" event from setting bit 3 in the status byte.<br>1 = enable an "instrument calibration" event to set bit 3 in the status byte.                   |
| 7   | 128    | 0 = inhibit a "modulation circuitry calibration" event from setting bit 3 in the status byte.<br>1 = enable a "modulation circuitry calibration" event to set bit 3 in the status byte. |
| 6   | 64     | X - don't care.   |
| 5   | 32     | 0 = inhibit a "frequency circuitry lock" event from setting bit 3 in the status byte.<br>1 = enable a "frequency circuitry lock" event to set bit 3 in the status byte.                 |
| 4   | 16     | 0 = inhibit a "reference oven temperature" event from setting bit 3 in the status byte.<br>1 = enable a "reference oven temperature" event to set bit 3 in the status byte.             |
| 3   | 8      | 0 = inhibit an "output power calibration" event from setting bit 3 in the status byte.<br>1 = enable an "output power calibration" event to set bit 3 in the status byte.               |
| 2   | 4      | X - don't care.   |
| 1   | 2      | X - don't care.   |
| 0   | 1      | X - don't care.   |

### Query Syntax

STATus:QUESTionable:ENABLE?

Returned format:

*number* <NL>

Where:

- *number* ::= The current value of the Questionable Event Enable register.

## See Also

STATUS:QUESTIONABLE[:EVENT]?  
STATUS:QUESTIONABLE:CONDITION?  
STATUS:QUESTIONABLE:PTRANSITION  
STATUS:QUESTIONABLE:NTRANSITION  
\*STB?

---

## STATUS:QUESTIONABLE[:EVENT]?

STATUS:QUESTIONABLE[:EVENT]?

The “STATUS:QUESTIONABLE[:EVENT]?” query returns the contents of the Questionable Event register.

---

The Questionable Event register holds a record of the state changes in the Questionable Condition register that were defined in the Questionable Edge Registers.

When you read the contents of the Questionable Event register, the value returned is the total bit weights of all the bits that are high at the time you read it. When you read the contents of the Questionable Event register using this command, the register is cleared (set to zero).

The decimal value of each bit (the bit weight) in the Questionable Event register is shown in the following table.



### Questionable Event Register Bit Definitions

| Bit | Weight | Condition  |
|-----|--------|--|
| 15  | 32768  | Not used - always 0.   |
| 14  | 16384  | Not used - always 0.   |
| 13  | 8192   | Not used - always 0.   |
| 12  | 4096   | Not used - always 0.   |
| 11  | 2048   | Not used - always 0.   |
| 10  | 1024   | Not used - always 0.   |
| 9   | 512    | Not used - always 0.   |
| 8   | 256    | 0 = an “instrument calibration” event has not occurred in the Questionable Condition register that is defined by the Questionable Edge registers.<br>1 = an “instrument calibration” event has occurred in the Questionable Condition register that is defined by the Questionable Edge registers.                   |
| 7   | 128    | 0 = a “modulation circuitry calibration” event has not occurred in the Questionable Condition register that is defined by the Questionable Edge registers.<br>1 = a “modulation circuitry calibration” event has occurred in the Questionable Condition register that is defined by the Questionable Edge registers. |
| 6   | 64     | Not used - always 0.   |
| 5   | 32     | 0 = a “frequency circuitry lock” event has not occurred in the Questionable Condition register that is defined by the Questionable Edge registers.<br>1 = a “frequency circuitry lock” event has occurred in the Questionable Condition register that is defined by the Questionable Edge registers.                 |
| 4   | 16     | 0 = a “reference oven temperature” event has not occurred in the Questionable Condition register that is defined by the Questionable Edge registers.<br>1 = a “reference oven temperature” event has occurred in the Questionable Condition register that is defined by the Questionable Edge registers.             |
| 3   | 8      | 0 = an “output power calibration” event has not occurred in the Questionable Condition register that is defined by the Questionable Edge registers.<br>1 = an “output power calibration” event has occurred in the Questionable Condition register that is defined by the Questionable Edge registers.               |
| 2   | 4      | Not used - always 0.   |
| 1   | 2      | Not used - always 0.   |
| 0   | 1      | Not used - always 0.   |

The Questionable Event register is also set to zero (0) after the “\*CLS” command is sent.

## See Also

STATUS:QUESTIONABLE:CONDITION?  
STATUS:QUESTIONABLE:ENABLE  
STATUS:QUESTIONABLE:PTRANSITION  
STATUS:QUESTIONABLE:NTRANSITION  
\*STB?

---

## STATUS:QUESTIONABLE:NTRANSITION

STATUS:QUESTIONABLE:NTRANSITION *number*

The “STATUS:QUESTIONABLE:NTRANSITION” command is used to define which bits in the Questionable Condition register will set the corresponding bit in the Questionable Event register on a one to zero state change.

The parameter is as follows:

*number*            The number representing the value of bits in the Questionable Negative Transition register to be set. The number must be from 0 to 32767.

---

The decimal value of each bit (the bit weight) in the Questionable Negative Transition register is shown in the following table.

### Questionable Negative Transition Register Bit Definitions

| Bit | Weight | Condition   |
|-----|--------|---|
| 15  | 32768  | can't set.  |
| 14  | 16384  | X - don't care.   |
| 13  | 8192   | X - don't care.   |
| 12  | 4096   | X - don't care.   |
| 11  | 2048   | X - don't care.   |
| 10  | 1024   | X - don't care.   |
| 9   | 512    | X - don't care.   |
| 8   | 256    | 0 = inhibit a one to zero state change of the "instrument calibration" bit from setting bit 8 in the Questionable Event register.<br>1 = enable a one to zero state change of the "instrument calibration" bit to set bit 8 in the Questionable Event register.                     |
| 7   | 128    | 0 = inhibit a one to zero state change of the "modulation circuitry calibration" bit from setting bit 7 in the Questionable Event register.<br>1 = enable a one to zero state change of the "modulation circuitry calibration" bit to set bit 7 in the Questionable Event register. |
| 6   | 64     | X - don't care.   |
| 5   | 32     | 0 = inhibit a one to zero state change of the "frequency circuitry lock" bit from setting bit 5 in the Questionable Event register.<br>1 = enable a one to zero state change of the "frequency circuitry lock" bit to set bit 5 in the Questionable Event register.                 |
| 4   | 16     | 0 = inhibit a one to zero state change of the "reference oven temperature" bit from setting bit 4 in the Questionable Event register.<br>1 = enable a one to zero state change of the "reference oven temperature" bit to set bit 4 in the Questionable Event register.             |
| 3   | 8      | 0 = inhibit a one to zero state change of the "output power calibration" bit from setting bit 3 in the Questionable Event register.<br>1 = enable a one to zero state change of the "output power calibration" bit to set bit 3 in the Questionable Event register.                 |
| 2   | 4      | X - don't care.   |
| 1   | 2      | X - don't care.   |
| 0   | 1      | X - don't care.   |

## Query Syntax

STATUS:QUESTIONABLE:NTRANSITION?

Returned format:

*number*<NL>

Where:

- *number* ::= The current value of the Questionable Negative Transition register.

## See Also

STATUS:QUESTIONABLE[:EVENT]?  
STATUS:QUESTIONABLE:CONDITION?  
STATUS:QUESTIONABLE:ENABLE  
STATUS:QUESTIONABLE:PTRANSITION  
\*STB?

---

## STATUS:QUESTIONABLE:PTRANSITION

STATUS:QUESTIONABLE:PTRANSITION *number*

The “STATUS:QUESTIONABLE:PTRANSITION” command is used to define which bits in the Questionable Condition register will set the corresponding bit in the Questionable Event register on a zero to one state change.

The parameter is as follows:

*number*            The number representing the value of bits in the Questionable Positive Transition register to be set. The number must be from 0 to 32767.

---

The decimal value of each bit (the bit weight) in the Questionable Positive Transition register is shown in the following table.

### Questionable Positive Transition Register Bit Definitions

| Bit | Weight | Condition   |
|-----|--------|---|
| 15  | 32768  | can't set.  |
| 14  | 16384  | X - don't care.   |
| 13  | 8192   | X - don't care.   |
| 12  | 4096   | X - don't care.   |
| 11  | 2048   | X - don't care.   |
| 10  | 1024   | X - don't care.   |
| 9   | 512    | X - don't care.   |
| 8   | 256    | 0 = inhibit a zero to one state change of the "instrument calibration" bit from setting bit 8 in the Questionable Event register.<br>1 = enable a zero to one state change of the "instrument calibration" bit to set bit 8 in the Questionable Event register.                     |
| 7   | 128    | 0 = inhibit a zero to one state change of the "modulation circuitry calibration" bit from setting bit 7 in the Questionable Event register.<br>1 = enable a zero to one state change of the "modulation circuitry calibration" bit to set bit 7 in the Questionable Event register. |
| 6   | 64     | X - don't care.   |
| 5   | 32     | 0 = inhibit a zero to one state change of the "frequency circuitry lock" bit from setting bit 5 in the Questionable Event register.<br>1 = enable a zero to one state change of the "frequency circuitry lock" bit to set bit 5 in the Questionable Event register.                 |
| 4   | 16     | 0 = inhibit a zero to one state change of the "reference oven temperature" bit from setting bit 4 in the Questionable Event register.<br>1 = enable a zero to one state change of the "reference oven temperature" bit to set bit 4 in the Questionable Event register.             |
| 3   | 8      | 0 = inhibit a zero to one state change of the "output power calibration" bit from setting bit 3 in the Questionable Event register.<br>1 = enable a zero to one state change of the "output power calibration" bit to set bit 3 in the Questionable Event register.                 |
| 2   | 4      | X - don't care.   |
| 1   | 2      | X - don't care.   |
| 0   | 1      | X - don't care.   |

## Query Syntax

STATUS:QUESTIONABLE:PTRANSITION?

Returned format:

*number* <NL>

Where:

- *number* ::= The current value of the Questionable Positive Transition register.

## See Also

STATUS:QUESTIONABLE[:EVENT]?  
STATUS:QUESTIONABLE:CONDITION?  
STATUS:QUESTIONABLE:ENABLE  
STATUS:QUESTIONABLE:NTRANSITION  
\*STB?



---

## \*STB? (Read Status Byte Query)

\*STB?

The “\*STB?” query returns the current value of the Signal Generator status byte.

---

When you read the contents of the status byte, the value returned is the total bit weights of all the bits that are high at the time you read it. When you read the contents of the status byte using the “\*STB?” query, the status byte is not cleared.

The decimal value of each bit (the bit weight) in the status byte is shown in the following table.

**Status Byte Bit Definitions**

| Bit | Weight | Name    | Condition  |
|-----|--------|---------|--|
| 7   | 128    | OPER    | 0 = no operation status events have occurred.<br>1 = an operation status event has occurred.         |
| 6   | 64     | RQS/MSS | 0 = instrument has no reason for service.<br>1 = instrument is requesting service.                   |
| 5   | 32     | ESB     | 0 = no event status conditions have occurred.<br>1 = an enabled event status condition has occurred. |
| 4   | 16     | MAV     | 0 = no output messages are ready.<br>1 = an output message is ready.                                 |
| 3   | 8      | QUES    | 0 = no questionable conditions have occurred.<br>1 = a questionable condition has occurred.          |
| 2   | 4      | -       | Not used - always 0.   |
| 1   | 2      | -       | Not used - always 0.   |
| 0   | 1      | -       | Not used - always 0.   |

The MSS (Master Summary Status) bit and not RQS is reported on bit 6. The MSS indicates whether or not the device has at least one reason for requesting service. To read the status byte with RQS reported on bit 6, use the HP-IB serial poll.

At power-up, the status byte is momentarily cleared (set to 0). After being cleared, the status registers will report their bit values.

### See Also

- \*CLS
- \*ESE
- \*ESR?
- \*SRE

## Error Messages

---

If an error condition occurs during signal generator operation, it is reported to two error queues: the front panel error queue and the HP-IB error queue. The following paragraphs describe these error queues and how to clear both transient and permanent errors from each.

### Transient and Permanent Errors

There are two types of errors that result in HP 70340A/41A error messages. Transient errors are cleared from an error queue after they are viewed. An example of a transient error is 603, "RF on/off command not valid;(603)." Most error messages result from transient error conditions. Permanent errors, on the other hand, will be reported back to an error queue even after the error message has been viewed until some action is performed (other than reading the queue) in order to correct the error. An example of a permanent error is 600, "ALC Loop went unlevelled;(600)encounter."

### Front Panel Error Queue

The HP 70340A **ERR** LED lights when an error message relating to the HP 70340A or the HP 70341A is sent to the front panel error queue. The front panel error queue holds the first 16 characters of the message. To read the front panel error queue:

1. Press **DISPLAY**
2. Select **REPORT ERRORS**
3. If the HP 70340A errors are not shown, select **MORE ERRORS** until they are shown.
4. Read the errors, and refer to the entries in this chapter, if necessary.
5. Press **MENU** to return to the instrument front panel menus.

If all errors were transient, reading the front panel error queue clears it, and thus, turns the **ERR** LED off. Accessing the front panel error queue, however, has no effect on the HP-IB error queue.

---

**Note** If the HP 70341A ERR LED lights, service is required.

---

### HP-IB Error Queue

The HP-IB query "SYSTem:ERRor?" is used to view the contents of the HP-IB error queue. The query returns the oldest uncleared error number and description from the queue. To read the entire contents of the queue, send the query until the message 0, "No error" is returned. Once this message is returned and all errors were transient, the HP-IB error queue clears. Accessing the HP-IB error queue has no effect on the front panel error queue or the HP 70340A **ERR** LED.

---

**Note** The "\*CLS" command clears transient errors (but not permanent errors) from *both* the front panel and the HP-IB error queues.

---

---

## Error Messages Format

The list of error messages in this chapter contains all of the error messages associated with signal generator operation. An example of the error format found in the list of error messages is as follows:

---

2003 **-222,"Data out of range;CW FREQ(2003)"**

Select a CW frequency that is within range for the installed options.

---

The following explains each element of an error message listing.

- **Manual Error Number** – The number 2003 to the left and in the parenthesis is called the Manual Error Number. The error message list is organized in ascending order off the manual error number. The manual error number will always be found in the parenthesis contained in the message.
- **Error Message** – The bold text **-222,"Data out of range;CW FREQ(2003)"** is the error message. When the **DISPLAY** and **REPORT ERRORS** keys are pressed, the first 16 characters of the error message are displayed. The entire message is returned by the HP-IB query "SYSTem:ERRor?". The error message contains the following parts:
  - **SCPI Error Number** – The standard SCPI error number (**-222** in the example) usually differs from the manual error number because the manual error number is unique for every possible message. Standard SCPI error numbers are always negative (except for 0, "No error"). If there is no standard SCPI error number for a message, the manual error number replaces it in the error message.
  - **SCPI Error Message** – The SCPI error message is **Data out of range** in the example.
  - **Detailed Description** – All information after the semicolon (;) is a detailed description of what exactly caused the error. In the example, **CW FREQ** tells you that CW frequency was out of range. If no detailed description exists, it will be omitted from the message.
- **Action Required** – The text that appears below each error message listing contains corrective actions that should be followed in order to correct the error condition. Note that the action required is never shown in the signal generator display.

---

### Notes

1. For more information related to error messages, refer to "To Check the Error Queue" in Chapter 2, the "ERR Led" reference entry in Chapter 9, and the "SYSTem:ERRor?" reference entry in Chapter 7.
  2. Error messages related to hardware failures are listed in the *HP 70340A Service Guide*.
-

---

## Error Messages List

The following pages list all error messages in ascending manual error number order:

- 440 **–440,”Query UNTERMINATED after indefinite response;(–440)”**

Correct the HP-IB controller program so that the query that returns indefinite length block data is the last item on the program line.
- 430 **–430,”Query DEADLOCKED;(–430)”**

Correct the HP-IB controller program so that no more than eight queries are executed within the same line of the program.
- 420 **–420,”Query UNTERMINATED;(–420)”**

Correct the HP-IB controller program so that the controller terminates commands with the newline character (NL) before the controller attempts to read query response data.
- 410 **–410,”Query INTERRUPTED;(–410)”**

Check the HP-IB controller program to see if the controller is programmed to read the entire query response data before issuing a subsequent command.
- 400 **–400,”Query error;(–400)”**

Some problem occurred while parsing an HP-IB query. Insure that your programming is correct and try the query again. Look at –440 through –400 for types of problems to look for.
- 350 **–350,”Queue overflow”**

The error queue overflowed at this point and this message replaced the 16th error message. No action is required. Note: To clear the HP-IB error queue, use \*CLS.
- 310 **–310,”System error;(–310)”**

Some problem occurred while parsing an HP-IB command or query. Insure that your programming is correct and try the command again.
- 278 **–278,”Macro header not found;(–278)”**

A \*GMC? or \*RMC macro label could not be found in the list of defined macro labels. Use \*LMC? to get a list of all the currently defined macro labels.
- 277 **–277,”Macro redefinition not allowed;(–277)”**

Indicates that a macro label in the \*DMC command could no be defined because the macro label was already defined.
- 276 **–276,”Macro recursion error;(–276)”**

The nesting/recursion of macros got deeper than 4 levels. Don’t use more than 4 levels when defining macros of macros.
- 275 **–275,”Macro definition too long;(–275)”**

The macro definition must be 255 characters or less.
- 274 **–274,”Macro parameter error;(–274)”**

A macro parameter placeholder was improperly used.
- 273 **–273,”Illegal macro label;(–273)”**

- Indicates that a macro label defined in the \*DMC command has a legal string syntax; but, it is too long, it is the same as a common command header, or contain invalid header syntax.
- 272 **–272,”Macro execution error;(–272)”**
- Indicates that a syntactically legal macro program data sequence could not be executed due to some error in the macro definition.
- 271 **–271,”Macro syntax error;(–271)”**
- Indicates that a syntax error exists in the macro definition.
- 224 **–224,”Illegal parameter value;(–224)”**
- Correct the HP-IB controller program so that the data included with the HP-IB command is an acceptable parameter for the command.
- 223 **–223,”Too much data;(–223)”**
- Correct the HP-IB controller program so that there is less data on a single command line. The signal generator does not have enough memory to buffer it all.
- 222 **–222,”Data out of range;(–222)”**
- The parameter data was out of range. Unlike other –222 errors, details are not known about the command or query which caused this error.
- 211 **–211,”Trigger ignored;(–211)”**
- There is no bus trigger capability in the signal generator.
- 200 **–200,”Execution error;(–200)”**
- Some problem occurred while executing an HP-IB command or query. Insure that your programming is correct and try the command again.
- 184 **–184,”Macro parameter error;(–184)”**
- Indicates that a command inside the macro definition had the wrong number or type of parameters.
- 183 **–183,”Invalid inside macro definition;(–183)”**
- Indicates that the program message sequence sent with \*DMC or \*DDT command, is syntactically invalid.
- 181 **–181,”Invalid outside macro definition;(–181)”**
- Indicates that a macro parameter placeholder was encountered outside of the macro definition.
- 178 **–178,”Expression data not allowed;(–178)”**
- Correct the HP-IB controller program so that the data included with the HP-IB command does not contain parentheses.
- 168 **–168,”Block data not allowed;(–168)”**
- Correct the HP-IB controller program so that the data included with the HP-IB command does not contain block data (no # character).
- 161 **–161,”Invalid block data;(–161)”**

#### **8-4 Error Messages**

- Correct the HP-IB controller program so that it contains a correct block data type. A block data type should begin with “#” followed by a number.
- 158 **–158,”String data not allowed;(-158)”**
- Correct the HP-IB controller program so that the data included with the HP-IB command does not contain string data (no single or double quote characters).
- 151 **–151,”Invalid string data;(-151)”**
- Correct the HP-IB controller program so that the string data included with the HP-IB command is terminated with a single or double quote. The terminating quote must be the same as the leading quote of the string. A string can also be valid if invalid characters are contained in it.
- 150 **–150,”String data error;(-150)”**
- The string data was too long to be buffered in the signal generator string data area.
- 148 **–148,”Character data not allowed;(-148)”**
- Correct the HP-IB controller program so that the data included with the HP-IB command is not character data.
- 144 **–144,”Character data too long;(-144)”**
- The character data element contains more than 12 characters.
- 141 **–141,”Invalid character data;(-141)”**
- Either the character data element contains an invalid character or the particular element is not valid for the command or query.
- 138 **–138,”Suffix not allowed;(-138)”**
- Correct the HP-IB controller program so that the decimal data included with the HP-IB command does not use a suffix. Use exponential notation instead.
- 134 **–134,”Suffix too long;(-134)”**
- The suffix contained more than 12 characters.
- 131 **–131,”Invalid suffix;(-131)”**
- Correct the HP-IB controller program so that the decimal data included with the HP-IB command contains a valid suffix for that command or query.
- 128 **–128,”Numeric data not allowed;(-128)”**
- Correct the HP-IB controller program so that the data included with the HP-IB command is not numeric data.
- 124 **–124,”Too many digits;(-124)”**
- The matissa of a decimal numeric data element contained more than 255 digits excluding leading zeros.
- 123 **–123,”Exponent too large;(-123)”**
- The magnitude of the exponent was larger than 32000.
- 121 **–121,”Invalid character in number;(-121)”**

- Correct the HP-IB controller program so that the decimal data or non-decimal numeric included with the HP-IB command contains the correct numeric characters.
- 120 **–120,”Numeric data error;(–120)”**  
An invalid numeric or non-decimal numeric was parsed but it was syntactically invalid.
- 114 **–114,”Header suffix out of range;(–114)”**  
Indicates that a header suffix was too large.
- 113 **–113,”Undefined header;(–113)”**  
The header is syntactically correct, but it is undefined for the signal generator.
- 112 **–112,”Program mnemonic too long;(–112)”**  
The header contains more than 12 characters.
- 109 **–109,”Missing parameter;(–109)”**  
This error indicates that an HP-IB command or query has too few parameters. Correct the HP-IB controller program so that the HP-IB command or query contains the correct number of parameters.
- 108 **–108,”Parameter not allowed;(–108)”**  
This error indicates that an HP-IB command or query has too many parameters. Correct the HP-IB controller program so that the HP-IB command or query contains the correct number of parameters.
- 105 **–105,”GET not allowed;(–105)”**  
Correct the HP-IB controller program so that the group execute trigger does not occur within a line of HP-IB program code.
- 104 **–104,”Data type error;(–104)”**  
The parser recognized a data element different than one allowed. For example, numeric or string data was expected but block data was encountered.
- 103 **–103,”Invalid separator;(–103)”**  
A separator was expected but an illegal character was encountered. For example, the space is missing from the following, `FREQ.01GHz`.
- 102 **–102,”Syntax error;(–102)”**  
An unrecognized command or data type was encountered.
- 101 **–101,”Invalid character;(–101)”**  
A syntactic element contains a character which is invalid for that type. For example, a header containing an ampersand would give this error.
- 100 **–100,”Command error;(–100)”**  
Some problem occurred while parsing an HP-IB command or query. Insure that your programming is correct and try the command again.
- 0 **0,”No error”**  
The error queue contains no errors.
- 110 **110,”EEPROM unprotected;(110)”**

## 8-6 Error Messages

The PG switch is set to 0 which leaves the EEPROM unprotected. Open up the signal generator and switch the PG switch to 1. This error message is only a warning.

511 **511,"YTO cal data init error;(511)"**

The YIG oscillator factory calibration data checksum was incorrect. A new YIG calibration should be performed or else the instrument may be unable to attain lock at some frequencies.

600 **600,"ALC loop went unlevelled;(600)"**

Power is set to a level that is higher than the instrument can supply. This is usually due to attenuator hold and the power is set to a value that requires the vernier to be operating out of its specified range. Change the power level or turn off attenuator hold. This is a "permanent" error.

601 **601,"Hardware driver Power limit;(601)"**

Due to instrument specials such as attenuator hold, the circuits cannot supply the specified power. Change the power level or turn off attenuator hold. This is a "permanent" error.

602 **602,"Vernier has been set to the limit;(602)"**

Due to instrument options such as attenuator hold, the circuits cannot supply the specified power. The vernier has been limited to a valid value. Change the power level or turn off attenuator hold. This is a "permanent" error.

603 **603,"RF on/off command not valid;(603)"**

An invalid request to turn off RF power was ignored by the instrument.

604 **604,"Atten driver error while setting level;(604)"**

The attenuators could not be set to the range requested. Change output power to a valid setting.

605 **605,"Vernier driver error while setting level;(605)"**

The vernier value requested was not possible. Change output power to a valid setting.

606 **606,"Level is not in guaranteed range.:(606)"**

The power level requested is beyond specifications and may be invalid. This could be due to a very low vernier setting required when attenuator hold is active. This is a "permanent" error.

608 **608,"Attenuator not set before Ext Meter mode;(608)"**

The attenuator range must match that of the meter range desired for External meter ALC mode. Turn off attenuator hold mode and make sure the power meter is in range hold before entering external power meter mode.

610 **610,"Track and hold failed, level is invalid;(610)"**

Power level was too high to do a power level setting in pulse or scan AM mode. Try setting power to a lower value.

611 **611,"Track and hold failed, level is invalid;(611)"**

Power level was too high to do a power level setting in pulse or scan AM mode. Try setting power to a lower value.



650 **650,"PG switch not set to 0;(650)"**

ALC calibration data was not saved in EEPROM because the PG switch was protecting the EEPROM from "writes". Open up the signal generator and switch the PG switch to 0.

651 **651,"Invalid vernier cal data for 1-20 GHz;(651)"**

Valid vernier calibration data is not available for the 1-20GHz band. If you need to use this frequency range, see the explanation for error number 4000.

652 **652,"ALC term verification after EEPROM write;(652)"**

ALC vernier calibration data was not written into EEPROM correctly. Try writing the data into the signal generator again.

653 **653,"Invalid vernier cal data for 0.01-1GHz;(653)"**

Valid vernier calibration data is not available for the 0.01-1GHz band. If you need to use this frequency range, see the explanation for error number 4000.

655 **655,"PG switch not set to 0;(655)"**

Factory frequency correction data was not saved in EEPROM because the PG switch was protecting the EEPROM from "writes". Open up the signal generator and switch the PG switch to 0.

656 **656,"Factory flatness cal data verification;(656)"**

Factory frequency level calibration data was not written into EEPROM correctly. Try writing the data into the signal generator again.

657 **657,"Factory flatness cal data is invalid;(657)"**

A valid factory frequency level calibration is not available for one or more of the frequency bands and/or attenuator settings. See the explanation for error number 4000.

670 **670,"Meter power input is out of range;(670)"**

The ALC input is not a valid level. The power meter range may be wrong. This is a "permanent" error.

700 **700,"Hardware driver Frequency limit;(700)"**

The frequency entered cannot be generated by the signal generator with the set of options available.

701 **701,"Lo synthesizer set error;(701)"**

The LO synthesizer cannot be set to the level requested. Enter a new frequency.

702 **702,"Offset synthesizer set error;(702)"**

The Offset synthesizer cannot be set to the level requested. Enter a new frequency.

704 **704,"YTO driver set error;(704)"**

The YIG oscillator cannot be set to the level requested. Enter a new frequency.

706 **706,"Low pass filter set error;(706)"**

The Low pass filter cannot be set to the requested setting. Enter a new frequency.

710 **710,"LO synthesizer went out of lock;(710)"**

## 8-8 Error Messages

- The LO synthesizer went out of lock. This may be due to hookup or disconnection of an external time base. Enter a different RF frequency and then set the frequency back to the desired value to re-lock. This is a “permanent” error.
- 711 **711,”Offset synthesizer went out of lock;(711)”**
- The offset synthesizer board was unable to attain lock. Enter a different RF frequency and then set the frequency back to the desired value to re-lock. This is a “permanent” error.
- 712 **712,”Frequency unlocked, possible FM overmod;(712)”**
- Enter a different RF frequency and then set the frequency back to the desired value to re-lock. This is a “permanent” error.
- 730 **730,”Invalid data in level correct table;(730)”**
- The active level correction table has no data in it. Select a level correction table with valid data, perform an automatic level correction to get valid data into the active table, or use HP-IB to load the active table. This is a “permanent” error.
- 731 **-226,”Tables not same length;Level correct(731)”**
- The active level correction table has a mismatch between the number of frequencies stored and the number of losses stored. Select a level correction table with valid data, perform an automatic level correction to get valid data into the active table, or use HP-IB to load tables with the same length. This is a “permanent” error.
- 732 **732,”Same frequencies with different losses;(732)”**
- The active level correction table has duplicate frequencies with different losses. Select a level correction table with valid data, perform an automatic level correction to get valid data into the active table, or use HP-IB to load tables with non-duplicate frequencies. This is a “permanent” error.
- 733 **733,”Frequency table not in ascending order;(733)”**
- The MEM:TABL:FREQ command did not contain frequencies in ascending order. The whole MEM:TABL:FREQ command was rejected, leaving the old selected table unaltered.
- 734 **734,”Frequency table not in ascending order;(734)”**
- The active level correction table does not contain frequencies in ascending order. Select a level correction table with valid data, perform an automatic level correction to get valid data into the active table, or use HP-IB to load a table with ascending ordered frequencies. This is a “permanent” error.
- 735 **735,”Level correct points less than 2;(735)”**
- The number of points in a level correction table must be from 2 to 401. Either too few points were entered or duplicate frequencies caused the number of “real” points to shrink below 2.
- 736 **736,”Factory level corr 1-20GHz, 1-9 table;(736)”**
- Factory frequency level correction data for 1-20GHz band, non-thru paths are not valid. If you need to use this frequency range and you are using a step attenuator, see the explanation for error number 4000.

- 737 **737,"Factory level corr 0.01-1GHz, 1-9 table;(737)"**  
Factory frequency level correction data for 0.01-1GHz band, non-thru paths are not valid. If you need to use this frequency range and you are using a step attenuator, see the explanation for error number 4000.
- 738 **738,"Factory level corr 0.01-1GHz, 0dB table;(738)"**  
Factory frequency level correction data for 0.01-1GHz band, thru path is not valid. If you need to use this frequency range and you work with output levels that don't use the step attenuator, see the explanation for error number 4000.
- 740 **740,"Another controller is on the HP-IB bus;(740)"**  
An automatic level correction was attempted but failed because there is a controller on the HP-IB bus. Remove all controllers from the HP-IB bus and try again.
- 741 **741,"No HP-IB devices found;(741)"**  
An automatic level correction was attempted but failed to find any other devices on the HP-IB bus. Connect the desired power meter to the HP-IB bus and try again. Check the HP-IB cable(s) for loose connections.
- 742 **742,"Errors in cleanup of HP-IB;(742)"**  
When exiting the automatic level correction, the signal generator failed to finish resetting the HP-IB bus and presetting the power meter. Make sure the power meter address matches the power meter address setting on the signal generator. Check the HP-IB cable(s) for loose connections.
- 743 **743,"No HP-IB devices found;(743)"**  
An automatic level correction was attempted but failed to find any other devices on the HP-IB bus. Connect the desired power meter to the HP-IB bus and try again. Make sure the power meter address matches the power meter address setting on the signal generator. Check the HP-IB cable(s) for loose connections.
- 744 **744,"Cannot find power meter on HP-IB bus;(744)"**  
An automatic level correction was attempted but failed to find a power meter on the HP-IB bus. Connect the desired power meter to the HP-IB bus and try again. Make sure the power meter address matches the power meter address setting on the signal generator. Check the HP-IB cable(s) for loose connections.
- 745 **745,"Meter returns error msg;(745)"**  
While running the automatic level correction, the power meter returned +9.0000E+40 as the power reading. This number indicates an error within the power meter.
- 746 **746,"Data measured is invalid or out of range;(746)"**  
While running the automatic level correction, the power meter returned an out of range power reading or the power meter returned a non-number as its power reading. Check that the power meter is reading an appropriate value by looking at it.
- 747 **747,"Unable to receive msg from meter;(747)"**  
An automatic level correction was attempted but failed to power readings back from the power meter. Make sure the power meter address matches the power meter address setting on the signal generator. Check the HP-IB cable(s) for loose connections.

- 748 **748,"Erasing corrupted level correct table;(748)"**  
A level correction table was corrupt and was erased to fix it.
- 749 **749,"Frequency not within level correct data;(749)"**  
This message is a warning that the current CW frequency is not contained within the frequencies in the active level correction table. Therefore, the correction applied to the output will be 0 dB. This is a "permanent" error.
- 752 **-222,"Data out of range;Data set to minimum(752)"**  
Loss data must be in the range of -40 to +40 dB.
- 753 **-222,"Data out of range;Data set to maximum(753)"**  
Loss data must be in the range of -40 to +40 dB.
- 754 **754,"Total points reduced from that requested;(754)"**  
The number of points requested for an automatic level correction has been reduced to avoid duplicate frequencies.
- 756 **756,"Factory level corr 1-20GHz, 0dB table;(756)"**  
Factory frequency level correction data for 1-20GHz band, thru path is not valid. If you need to use this frequency range and you work with output levels that don't use the step attenuator, see the explanation for error number 4000.
- 757 **757,"Bad attenuator setting parameter;(757)"**  
The attenuator range for looking up factory frequency level correction data, is 0 through 120 (resolution is 10).
- 758 **-222,"Data out of range;Data set to minimum(758)"**  
Loss data for factory frequency level correction was less than minimum.
- 759 **-222,"Data out of range;Data set to maximum(759)"**  
Loss data for factory frequency level correction was more than maximum.
- 760 **760,"Bad index into data table;(760)"**  
A data lookup from a calibration table found that the index data is out of range. Try setting the same signal generator function again. If this error message persists, run the instrument self-test.
- 761 **761,"Bad index into offset table;(761)"**  
A data lookup from the factory level correction offset table found that the index data is out of range. Try setting the same signal generator function again. If this error message persists, run the instrument self-test.
- 763 **763,"Unable to write to EEPROM;(763)"**  
Calibration table was not loaded into EEPROM because the EEPROM was protected or the EEPROM load did not verify. Open up the signal generator and switch the PG switch to 0.
- 764 **764,"Unable to write to RAM;(764)"**  
A write to RAM failed to verify. Run the self-test routine to check RAM for problems.

765 **765,"Attempt to write to ROM;(765)"**

There was attempt to write calibration data to ROM. This should not occur, but if it does, try setting the same signal generator function again. If this error message persists, run the instrument self-test.

766 **766,"Number of writes to EEPROM exceeds max;(766)"**

The number of EEPROM writes has exceeded the maximum allowed. However, the data was written to the EEPROM anyway. This is only a warning; but, you should check to make sure your data was correctly stored in EEPROM.

770 **770,"YTO cal data invalid;(770)"**

The YIG oscillator factory calibration data checksum was incorrect. Select the **CAL YIG OSC** function under the **service** menu to perform a YIG oscillator calibration. If you do not re-calibrate, the signal generator may be unable to attain lock at some frequencies.

771 **771,"Invalid YIG DAC value in cal table.:(771)"**

The YIG oscillator factory calibration data checksum was incorrect. Select the **CAL YIG OSC** function under the **service** menu to perform a YIG oscillator calibration. If you do not re-calibrate, the signal generator may be unable to attain lock at some frequencies.

772 **772,"YTO cal values for Up/Down search vary;(772)"**

The YIG oscillator factory calibration data checksum was incorrect. Select the **CAL YIG OSC** function under the **service** menu to perform a YIG oscillator calibration. If you do not re-calibrate, the signal generator may be unable to attain lock at some frequencies.

774 **774,"EEPROM protected, YTO cal aborted;(774)"**

An automatic YIG oscillator calibration was not performed because the PG switch was protecting the EEPROM from "writes". Open up the signal generator and switch the PG switch to 0.

775 **775,"Low band yto cal failed;(775)"**

The low band calibration failed and the data for the calibration was not saved. Re-try the YIG calibration and watch for the default cal points indicated when the DAC value shown for a given point says 'dflt = ' instead of 'DAC = '.

776 **776,"High band yto cal failed;(776)"**

The low band calibration failed and the data for the calibration was not saved. Re-try the YIG calibration and watch for the default cal points indicated when the DAC value shown for a given point says 'dflt = ' instead of 'DAC = '.

777 **777,"Low band yto cal could not write EEPROM;(777)"**

The data for the low band YIG calibration could not be written to EEPROM. Make sure the PG switch on the processor board was closed during the cal and re-try the YIG calibration.

778 **778,"High band yto cal could not write EEPROM;(778)"**

The data for the low band YIG calibration could not be written to EEPROM. Make sure the PG switch on the processor board was closed during the cal and re-try the calibration.

**779 779,"Only 2GHz or 10GHz allowed for YTO Cal;(779)"**

The start frequency specified for the CAL:YIG:FREQ:START command was not valid. Re-enter the start frequency and start the YIG calibration again.

**785 785,"Cal Data not saved, PG switch is not 0;(785)"**

The calibration data could not be saved because the PG switch on the microprocessor board was not closed. Close the PG switch and do the calibration again.

**786 786,"Cal Data verification after EEPROM write;(786)"**

The calibration data was not written correctly after the calibration. Close the PG switch and do the calibration again.

**787 787,"FM cal and Pinchoff cal not initialized;(787)"**

The YIG calibration has not been done for both YIG bands or else the pinchoff cal values have not been entered yet.

**790 790,"Scan-mod 0.01-1 GHz gain tables bad;(790)"**

Checksum was invalid for the AM gain tables. If you need to use this frequency range and scan AM modulation, see the explanation for error number 4000.

**793 793,"Scan AM cal not valid, defaults used;(793)"**

Scan AM level may be in error due to invalid calibration data. If you need to use scan AM modulation, see the explanation for error number 4000.

**794 794,"Scan-mod 1-20 GHz gain tables bad;(794)"**

Checksum was invalid for the AM scan gain tables. If you need to use this frequency range and scan AM modulation, see the explanation for error number 4000.

**795 795,"Scan-mod 1-20 GHz linear 1 tables bad;(795)"**

Checksum was invalid for the AM scan linear 1 tables. If you need to use this frequency range and scan AM modulation, see the explanation for error number 4000.

**796 796,"Scan-mod 1-20 GHz linear 2 tables bad;(796)"**

Checksum was invalid for the AM scan linear 2 tables. If you need to use this frequency range and scan AM modulation, see the explanation for error number 4000.

**800 800,"Options not saved, PG switch is not 0;(800)"**

The instrument option bit-fields were not saved to EEPROM. Open up the signal generator, switch the PG switch to 0, and try setting the option bit-fields again.

**801 801,"Serial num not saved, PG switch is not 0;(801)"**

The instrument serial number was not saved to EEPROM. Open up the signal generator, switch the PG switch to 0, and try setting the serial number again.

**900 900,"PRI increased to fit pulse width;(900)"**

The current pulse width is too large for the current PRI. The PRI is increased to allow for the pulse width. This is a "permanent" error.

- 901 **901,"Delay and width decreased to fit max PRI;(901)"**  
The current pulse width plus the current pulse delay is too large because they are greater than the maximum PRI. The delay and/or the width were reduced to fit. This is a "permanent" error.
- 940 **940,"Oven is cold;(940)"**  
The high stability time base oven is cold. The oven must be allowed to warm up before proper instrument operation will occur. This is a "permanent" error.
- 944 **944,"Reference synthesizer went out of lock;(944)"**  
The reference synthesizer went out of lock. The out of lock condition may have been due to an external time base being connected or disconnected. Enter a different RF frequency and then set the frequency back to the desired value to re-lock. This is a "permanent" error.
- 1101 **1101,"Loop number is invalid.:(1101)"**  
If you are using the direct hardware control service feature, you have entered an out of range value. If this error occurs while not using the direct hardware control service feature, low level hardware drivers could not set the requested signal generator setting. Try setting the signal generator again. If this error message persists, run the instrument self-test.
- 1102 **1102,"Start bit is negative.:(1102)"**  
See the explanation for error number 1101.
- 1103 **1103,"Length less than 0 or more than 32;(1103)"**  
See the explanation for error number 1101.
- 1104 **1104,"Start bit is invalid for given loop.:(1104)"**  
See the explanation for error number 1101.
- 1105 **1105,"Length is invalid for given loop;(1105)"**  
See the explanation for error number 1101.
- 1106 **1106,"Data is too large for given length;(1106)"**  
See the explanation for error number 1101.
- 1107 **-222,"Data out of range;Bit field number(1107)"**  
See the explanation for error number 1101.
- 1108 **-222,"Data out of range;Query port field(1108)"**  
If you are using the direct hardware control service feature, you have entered an out of range query address. If this error occurs while not using the direct hardware control service feature, low level hardware drivers could not complete a query. Try setting the signal generator again. If this error message persists, run the instrument self-test.
- 1109 **1109,"Query Port mode;(1109)"**  
See the explanation for error number 1108.
- 1801 **1801,"Slave Module Not Present;(1801)"**

The slave module accessed by SYST:PTHR:ADDR is not present in the MMS main frame(s). Check that the slave shows up in the “address map” on the display.

1802 **1802,”Low Battery Voltage;(1802)”**

The signal generator battery voltage is low. This could cause loss of RAM data if signal generator power is turned off. Note: Calibration data will never be lost.

1803 **1803,”RAM data lost at power on;(1803)”**

All RAM data was lost. This includes all front panel settings, save/recall registers, level corrections, and other user settable values. This error message can occur when the battery voltage is low, or options change in the signal generator. Note: Calibration data will never be lost.

1804 **1804,”Self-test failure, run the self-test;(1804)”**

The power-on self-test detected an error or warning. See the explanation for error number 4000.

1805 **1805,”Processor Board or IBUS test Failure;(1805)”**

The power-on self-test detected an error or warning for the microprocessor board circuits or power supply monitors. See the explanation for error number 4000.

1806 **1806,”ROM checksum test failure;(1806)”**

The signal generator ROM check sum does not match the data in ROM. See the explanation for error number 4000.

2003 **–222,”Data out of range;CW FREQ(2003)”**

Select a CW frequency that is within range of the installed options. If other slave modules are installed that extend the CW frequency range of the signal generator, this frequency range will be extended also.

2006 **–222,”Data out of range;POWER LEVEL(2006)”**

Select a power level within the following ranges:  
No attenuator options, -15 dBm to +30 dBm. Option 1E1, -100 dBm to +30 dBm.

2018 **–222,”Data out of range;FREQ MULTIPLIER INCR(2018)”**

Select a frequency multiplier increment from 1 to 99.

2024 **–222,”Data out of range;CW FREQ INCR(2024)”**

Select a CW frequency increment from 1kHz to 19.99GHz. If other slave modules are installed that extend the CW frequency range of the signal generator, this frequency range will be extended also. If the 1E8 option is installed the limits will also change to allow for 1 hertz resolution.

2030 **–222,”Data out of range;DIRECT HW CONTROL(2030)”**

Select signal generator direct hardware control values within range. See the Service Manual for more details on this feature.

2033 **–222,”Data out of range;POWER LEVEL INCR(2033)”**

Select a power level within the following ranges:  
No attenuator options, 0.01 dBm to +45 dBm. Option 1E1, 0.01 dBm to +130 dBm.

2036 **–222,”Data out of range;EXT METER LEVEL(2036)”**



Select an external power meter reading within the following ranges:  
No attenuator options, -15 dBm to +30 dBm. Option 1E1, -100 dBm to +30 dBm.

**2042 –222,”Data out of range;DIAG:IBUS:DIR(2042)”**

Correct the HP-IB command DIAG:IBUS:DIR or DIAG:IBUS:DIR? so that its parameters are within their appropriate ranges. See the Service Manual for more details on this HP-IB only feature.

**2051 –161,”Invalid block data;SYST:SET bad size(2051)”**

The “learn string” sent to the signal generator is corrupt (incorrect number of bytes). Check that the HP-IB controller is sending the string correctly. In addition, insure that the controller loaded the learn string correctly in the first place. Note: The \*LRN? query always returns the same length string regardless of the state of the signal generator; but, the \*LRN? response can change if the firmware version changes.

**2054 –222,”Data out of range;CAL:ALC:CURV(2054)”**

Correct the HP-IB command CAL:ALC:CURV so that its parameters are within the following ranges:

1st parameter: 0.0 to 4.0

2nd parameter: -2.0 to 2.0

3rd-6th parameter: -1.0 to 1.0

7th parameter: 0.0 to 25.0

**2057 –222,”Data out of range;HPIB ADDRESS(2057)”**

Select an HP-IB address for the signal generator from 0 to 30.

**2060 –222,”Data out of range;SAVE(2060)”**

Select a save state register number from 0 to 9.

**2066 –222,”Data out of range;RECALL(2066)”**

Select a recall state register number from 0 to 9.

**2069 –224,”Illegal parameter value;SYST:PTHR(2069)”**

Correct the HP-IB command SYST:PTHR or SYST:PTHR? so that its string parameter is 255 characters or less.

**2072 –224,”Illegal parameter value;SYST:PTHR:ADDR(2072)”**

Correct the HP-IB command SYST:PTHR:ADDR so that its string parameter is 25 characters or less.

**2075 –222,”Data out of range;LO FREQ(2075)”**

Select an LO frequency from 300 MHz to 359.5 MHz.

**2078 –222,”Data out of range;OFFSET FREQ(2078)”**

Select an offset frequency from 5 MHz to 40 MHz.

**2081 –222,”Data out of range;DIAG:FREQ:CYCL(2081)”**

Correct the HP-IB command DIAG:FREQ:CYCL so that its parameters are within range. See the Service Manual for more details on this feature.

**2087 –222,”Data out of range;YIG OSC CAL FREQ(2087)”**

- Correct the HP-IB command CAL:YIG:FREQ:START so that its parameter is 2 GHz or 10 GHz.
- 2090 –222, "Data out of range;CAL:YIG(2090)"
- Correct the HP-IB command CAL:YIG[:DATA] so that all of its parameters are from 0 to 65535.
- 2099 –222, "Data out of range;FREQ MULTIPLIER(2099)"
- Select a frequency multiplier from 1 to 100.
- 2102 –222, "Data out of range;EXT METER INCR(2102)"
- Select an external power meter reading increment within the following ranges:  
No attenuator options, 0.01 dBm to +45 dBm. Option 1E1, 0.01 dBm to +130 dBm.
- 2105 –222, "Data out of range;CAL:ALC:CURV:FREQ(2105)"
- Correct the HP-IB command CAL:ALC:CURVe:FREQUency:START so that its parameter is from 10 MHz to 40 GHz. See the Service Manual for more details on this feature.
- 2114 –224, "Illegal parameter value;ATTEN LOCK(2114)"
- The HP-IB command "POWER:ATTenuation:AUTO OFF" can only be used if the 1E1 option is installed.
- 2138 –224, "Illegal parameter value;PULSE SOURCE(2138)"
- The HP-IB command PULM:SOURce only allows EXTernal as a parameter.
- 2159 –224, "Illegal parameter value;AM TYPE(2159)"
- The HP-IB command AM:TYPE only allows EXPonential as a parameter.
- 2165 –224, "Illegal parameter value;REMOTE LANGUAGE(2165)"
- Select an HP-IB remote language which is available in the signal generator. "SCPI" is the default but others are available as options.
- 2177 –222, "Data out of range;CAL:FLAT(2177)"
- Loss data for factory frequency level correction was out of range.
- 2216 –222, "Data out of range;NODE MEASURE(2216)"
- Select a meter node number within range. See the Service Manual for more details on this feature.
- 2219 –222, "Data out of range;OPTION WRITE(2219)"
- Select an option bit-field number within range. See the Service Manual for more details on this feature.
- 2225 –222, "Data out of range;FM SENSITIVITY(2225)"
- Select an FM sensitivity withing its range for the current CW frequency and multiplier.
- 2237 –222, "Data out of range;OFFSET FREQ INCR(2237)"
- Select an offset frequency increment from 1 Hz to 35 MHz.
- 2240 –222, "Data out of range;LO FREQ INCR(2240)"

Select an LO frequency increment from 1 kHz to 359.5 MHz.

**2243 –222,”Data out of range;DIRECT HW CONTROL INC(2243)”**

Select signal generator direct hardware control increment values within range. See the Service Manual for more details on this feature.

**2246 –224,”Illegal parameter value;INIT:CONT(2246)”**

The HP-IB command INIT:CONTinuous only allows ON as a parameter.

**2249 –222,”Data out of range;DIAG:ABUS?(2249)”**

Correct the HP-IB query DIAG:ABUS? so that its parameter is within their appropriate range. See the Service Manual for more details on this HP-IB only feature.

**2252 –222,”Data out of range;CAL:AM:LIN(2252)”**

Correct the HP-IB command CAL:AM:LINear[:DATA] so that all of its parameters are from 0 to 255.

**2255 –222,”Data out of range;CAL:AM:LIN:TABL(2255)”**

Correct the HP-IB command CAL:AM:LINear:TABLE so that its parameter is 1 or 2.

**2264 –222,”Data out of range;CAL:YIG:FM:SENS(2264)”**

Correct the HP-IB command CAL:YIG:FM:SENSitivity so that all of its parameters are from -80 to 80.

**2276 –222,”Data out of range;CORR:FLAT(2276)”**

Correct the HP-IB command CORRection:FLATness[:DATA] so that all of its frequency parameters are from 1 GHz to 20 GHz and all of its loss parameters are from -40 dB to +40 dB. If other slave modules are installed that extend the frequency range of the signal generator, this frequency range will be extended also.

**2277 2277,”CORR:FLAT cannot query empty table;(2277)”**

The selected level correction table data cannot be queried because it is invalid or it does not exist. Check that MEMory:TABLE:SElect is set to a level correction table that has data.

**2291 –224,”Illegal parameter value;SERIAL NUM(2291)”**

Correct the HP-IB command DIAG:SNUMber so that its string parameter is 10 characters or less.

**2292 –151,”Invalid string data;SERIAL NUM bad char(2292)”**

A serial number can only contain characters from ASCII 32 (space) through ASCII 126 (~). However, ASCII 44 (,) and ASCII 59 (;) cannot be used as well.

**2294 –222,”Data out of range;POW METER ADDRESS(2294)”**

Select a power meter address for automatic level correction from 0 to 30. Secondary addresses may be allowed in future firmware revisions.

**2300 –222,”Data out of range;CAL:FLAT:FREQ:START(2300)”**

Correct the HP-IB command CAL:FLATness:FREQuency:STARt so that its parameter is from 10 MHz to 40 GHz. See the Service Manual for more details on this feature.

**2303 –222,”Data out of range;CAL:FLAT:ATT(2303)”**

**8-18 Error Messages**

Correct the HP-IB command CAL:FLATness:ATTenuation so that its parameter is from 0 dB to 120 dB with a resolution of 10 dB. See the Service Manual for more details on this feature.

**2306 –222, "Data out of range;CAL:AM(2306)"**

Correct the HP-IB command CAL:AM[:DATA] so that all of its parameters are from 0 to 255.

**2309 –222, "Data out of range;CAL:AM:FREQ:START(2309)"**

Correct the HP-IB command CAL:AM:FREQuency:STARt so that its parameter is from 10 MHz to 40 GHz. See the Service Manual for more details on this feature.

**2444 –222, "Data out of range;LEVEL CORR START FREQ(2444)"**

Select an automatic level correction start frequency from 1GHz to 20GHz. If other slave modules are installed that extend the CW frequency range of the signal generator, this frequency range will be extended also.

**2447 –222, "Data out of range;LEVEL CORR STOP FREQ(2447)"**

Select an automatic level correction start frequency from 1GHz to 20GHz. If other slave modules are installed that extend the CW frequency range of the signal generator, this frequency range will be extended also.

**2457 2457, "RF on before running level correct;(2457)"**

The RF must be turned on before running an automatic level correction. Turn RF on and try running the automatic level correction again.

**2462 –222, "Data out of range;LEVEL CORR START INC(2462)"**

Select an automatic level correction start frequency increment from 1kHz to 19.99GHz. If other slave modules are installed that extend the CW frequency range of the signal generator, this frequency range will be extended also. If the 1E8 option is installed the limits will also change to allow for 1 hertz resolution.

**2465 –222, "Data out of range;LEVEL CORR STOP INC(2465)"**

Select an automatic level correction stop frequency increment from 1kHz to 19.99GHz. If other slave modules are installed that extend the CW frequency range of the signal generator, this frequency range will be extended also. If the 1E8 option is installed the limits will also change to allow for 1 hertz resolution.

**2471 –222, "Data out of range;HPIB ADDRESS INCR(2471)"**

Select an HP-IB address increment from 1 to 29.

**2474 –222, "Data out of range;YIG OSC CAL FREQ INC(2474)"**

Correct the HP-IB command CAL:YIG:FREQuency:STARt:STEP so that its parameter is from 1 GHz to 10 GHz.

**2477 –222, "Data out of range;CAL:PULSe:PINCh(2477)"**

Correct the HP-IB command CAL:PULSe:PINCh[:DATA] so that all of its parameters are from 0 to 255.

**2480 –222, "Data out of range;CAL:PULS:FREQ:START(2480)"**

- Correct the HP-IB command CAL:PULSe:FREQuency:STARt so that its parameter is 10 MHz.
- 2522 –222, "Data out of range;POW METER ADDRESS INC(2522)"  
Select a power meter address increment from 1 to 29.
- 2525 –222, "Data out of range;NODE MEASURE INC(2525)"  
Select a meter node increment within range.
- 2528 –222, "Data out of range;OPTION WRITE INC(2528)"  
Select an option bit-field increment within range.
- 2534 –222, "Data out of range;LEVEL CORR POINTS(2531)"  
Select automatic level correction number of points from 2 to 401.
- 2534 –222, "Data out of range;LEVEL CORR POINTS INC(2534)"  
Select automatic level correction number of points increment from 1 to 401.
- 2591 –222, "Data out of range;MEM:TABL:FREQ(2591)"  
Correct the HP-IB command MEMory:TABLE:FREQuency so that all of its parameters are from 1 GHz to 20 GHz. If other slave modules are installed that extend the frequency range of the signal generator, this frequency range will be extended also.
- 2592 **2592, "MEM:TABL:FREQ cannot query empty table;(2592)"**  
The selected level correction table data cannot be queried because it is invalid or it does not exist. Check that MEMory:TABLE:SElect is set to a level correction table that has data.
- 2597 –222, "Data out of range;MEM:TABL:LOSS(2597)"  
Correct the HP-IB command MEMory:TABLE:LOSS[:MAGnitude] so that all of its parameters are from -40 dB to +40 dB.
- 2598 **2598, "MEM:TABL:LOSS cannot query empty table;(2598)"**  
The selected level correction table data cannot be queried because it is invalid or it does not exist. Check that MEMory:TABLE:SElect is set to a level correction table that has data.
- 2627 –224, "Illegal parameter value;FM:FEED(2657)"  
Change the FM:FEED input parameter to a source that is available in the signal generator.
- 2657 –224, "Illegal parameter value;AM:FEED(2657)"  
Change the AM:FEED input parameter to a source that is available in the signal generator.
- 2702 –222, "Data out of range;ADD OPTION(2702)"  
Select an option bit number within range. See the Service Manual for more details on this feature.
- 2705 –222, "Data out of range;DELETE OPTION(2705)"

Select an option bit number within range. See the Service Manual for more details on this feature.

4000 **-330,"Self-test failed;(4000)"**

Run the instrument self-test a couple times, checking the error queue each time the self-test is run. If the error message persists, use the ERASE MEMORY feature, press the preset key and cycle the power; try the self-test again. If the error message persists, an instrument failure may have occurred and servicing may be required. If the signal generator is functioning to your satisfaction, you may wish to ignore the error message.

4001 **-330,"Self-test failed;(4001)"**

See the explanation for error number 4000.

4002 **-330,"Self-test failed;(4002)"**

See the explanation for error number 4000.

4003 **-330,"Self-test failed;(4003)"**

See the explanation for error number 4000.

4004 **-330,"Self-test failed;(4004)"**

See the explanation for error number 4000.

4005 **-330,"Self-test failed;(4005)"**

See the explanation for error number 4000.

4006 **-330,"Self-test failed;(4006)"**

See the explanation for error number 4000.

4007 **-330,"Self-test failed;(4007)"**

See the explanation for error number 4000.

4008 **-330,"Self-test failed;(4008)"**

See the explanation for error number 4000.

4009 **-330,"Self-test failed;(4009)"**

See the explanation for error number 4000.

4010 **-330,"Self-test failed;(4010)"**

See the explanation for error number 4000.

4011 **-330,"Self-test failed;(4011)"**

See the explanation for error number 4000.

4012 **-330,"Self-test failed;(4012)"**

See the explanation for error number 4000.

4013 **-330,"Self-test failed;(4013)"**

See the explanation for error number 4000.

4014 **-330,"Self-test failed;(4014)"**

See the explanation for error number 4000.

- 4015 –**330**,”Self-test failed;(4015)”  
See the explanation for error number 4000.
- 4016 –**330**,”Self-test failed;(4016)”  
See the explanation for error number 4000.
- 4017 –**330**,”Self-test failed;(4017)”  
See the explanation for error number 4000.
- 4018 –**330**,”Self-test failed;(4018)”  
See the explanation for error number 4000.
- 4019 –**330**,”Self-test failed;(4019)”  
See the explanation for error number 4000.
- 4020 –**330**,”Self-test failed;(4020)”  
See the explanation for error number 4000.
- 4021 –**330**,”Self-test failed;(4021)”  
See the explanation for error number 4000.
- 4022 –**330**,”Self-test failed;(4022)”  
See the explanation for error number 4000.
- 4023 –**330**,”Self-test failed;(4023)”  
See the explanation for error number 4000.
- 4024 –**330**,”Self-test failed;(4024)”  
See the explanation for error number 4000.
- 4025 –**330**,”Self-test failed;(4025)”  
See the explanation for error number 4000.
- 4026 –**330**,”Self-test failed;(4026)”  
See the explanation for error number 4000.
- 4027 –**330**,”Self-test failed;(4027)”  
See the explanation for error number 4000.
- 4028 –**330**,”Self-test failed;(4028)”  
See the explanation for error number 4000.
- 4029 –**330**,”Self-test failed;(4029)”  
See the explanation for error number 4000.
- 4030 –**330**,”Self-test failed;(4030)”  
See the explanation for error number 4000.
- 4031 –**330**,”Self-test failed;(4031)”  
See the explanation for error number 4000.

## **8-22 Error Messages**

4032 –330,”Self-test failed;(4032)”

See the explanation for error number 4000.

4033 –330,”Self-test failed;(4033)”

See the explanation for error number 4000.

4034 –330,”Self-test failed;(4034)”

See the explanation for error number 4000.

4035 –330,”Self-test failed;(4035)”

See the explanation for error number 4000.

4036 –330,”Self-test failed;(4036)”

See the explanation for error number 4000.

4037 –330,”Self-test failed;(4037)”

See the explanation for error number 4000.

4038 –330,”Self-test failed;(4038)”

See the explanation for error number 4000.

4039 –330,”Self-test failed;(4039)”

See the explanation for error number 4000.

4040 –330,”Self-test failed;(4040)”

See the explanation for error number 4000.

4041 –330,”Self-test failed;(4041)”

See the explanation for error number 4000.

4042 –330,”Self-test failed;(4042)”

See the explanation for error number 4000.

4043 –330,”Self-test failed;(4043)”

See the explanation for error number 4000.

4044 –330,”Self-test failed;(4044)”

See the explanation for error number 4000.

4045 –330,”Self-test failed;(4045)”

See the explanation for error number 4000.

9000 –330,”Self-test failed;(9000)”

See the explanation for error number 4000.

9500- **Many different error messages can occur here.**

Errors with a number from 9500 to 9999 are MMS MSIB errors. These errors occur when the signal generator has some problem with communication over the MSIB bus. See the explanation for error number 4000.





## Front and Rear Panel

---

This chapter contains the HP 70340A and HP 70341A front and rear panel hardware features. Also included are some mainframe features that are necessary for instrument operation. Entries include connectors, LEDs, the LINE switch, the module latch, and the power cable. For HP 70341A rear panel connectors, refer to the “Specifications and Options” chapter of this book.

The entries in this chapter are alphabetized. The front and rear panel connectors are alphabetized under the main headings “Front Panel Connectors” and “Rear Panel Connectors,” while the LEDs are alphabetized under the heading “LEDs”.

---

## Accessories (included)

The HP 70340A shipment includes the following:

- HP 70340A modular signal generator
- *HP 70340A/41A User's Guide*
- *HP 70340A/41A Quick Start Guide*
- *HP 70340A/41A Calibration Guide* with Software Disks

If Option 0B2 was ordered, the following extra set of the user documentation is included:

- *HP 70340A/41A User's Guide*
- *HP 70340A/41A Quick Start Guide*
- *HP 70340A/41A Calibration Guide* with Software Disks

If Option 0BW was ordered, assembly-level service documentation, the *HP 70340A Service Guide*, is provided along with the user documentation.

If Option 0BV was ordered, component-level service information, the *HP 70340A Component Level Information Manual*, is provided along with the user documentation.

Note that a power cable is not shipped with the HP 70341A. It is supplied with the mainframe or stand-alone display.

Refer to the *HP 70341A Installation Guide* for HP 70341A shipment contents.

---

## Accessories (not included)

Several accessories (such as cables) which are not included with the HP 70340A may be required for certain applications.

**Table 9-1. Accessories (not included)**

| Accessory   | Part Number |
|---|-------------|
| HP-MSIB Cable- 5 meter                            | HP 70800A   |
| HP-MSIB Cable- 1.0 meter                          | HP 70800B   |
| HP-MSIB Cable- 2.0 meter                          | HP 70800C   |
| HP-MSIB Cable- 6.0 meter                          | HP 70800D   |
| HP-MSIB Cable- 30 meter                           | HP 70800E   |
|   |             |
| SMB push-on Cable- 15 cm (rear panel connections) | 08753-60061 |
| SMB push-on Cable- 30 cm (rear panel connections) | 5061-1022   |
|   |             |
| SMA flex coax Cable (inter-module connections)    | 5061-9038   |
| SMA flex coax Cable (mainframe connections)       | 5061-9039   |
|   |             |
| SMB(f) to BNC(m) Cable                            | 85680-60093 |
| SMA(f) to SMA(m) Cable                            | 8120-1578   |
|   |             |
| 8mm hex ball Driver (module removal/installation) | 8710-1307   |
|   |             |
| Fuse- 6.3 A (for replacement in mainframe)        | 2110-0703   |

For rack mounting kits, refer to your display or mainframe manuals.

## Connectors- HP 70340A Front Panel

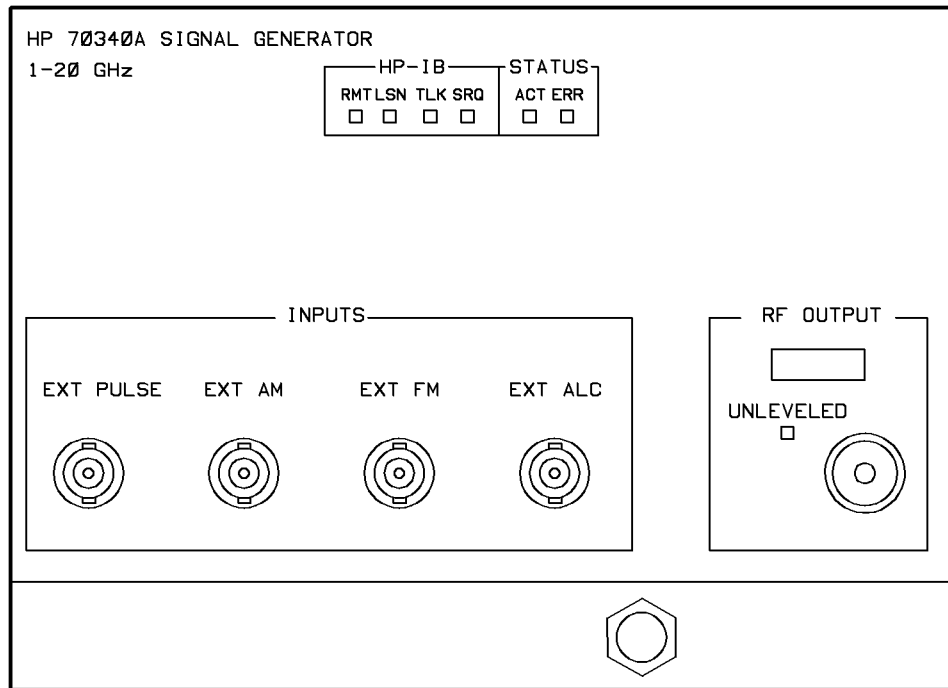

Figure 9-1. HP 70340A Connectors - Front Panel

### EXT ALC

This front panel BNC connector allows external leveling of the HP 70340A. **EXT ALC** is used with external power meter leveling (ALC POWER METER) or external diode leveling (ALC DIODE). The leveling signal at this input must be in the  $\pm 1V$  range. The nominal input impedance is 150 k $\Omega$ . The damage level is  $\geq +12V$  or  $\leq -12V$ .

### EXT AM

The **EXT AM** BNC connector provides the amplitude modulating signal input when LOG AM On/Off is **On**. Every  $-1V$  change in the signal at this connector decreases the level at the **RF OUTPUT** connector by 10 dB when the signal generator is set to log AM mode. The amplitude modulation changes logarithmically at a  $-10$  dB/V rate. The input range is  $-10$  to  $+10$  dBm. Signals less than 0V have no effect on the **RF OUTPUT** power. When the level at the **EXT AM** connector equals 0V, the **RF OUTPUT** power is unchanged. The input impedance at the **EXT AM** connector is 600  $\Omega$ . The damage level is  $\geq +12V$  or  $\leq -12V$ .

## EXT FM

This front panel BNC connector provides the frequency modulating signal input when DC or AC FM is enabled. This input accepts a modulating signal between +2V and -2V. The FM deviation is proportional to the voltage at the **FM IN** connector. The nominal input impedance of this connector is 600Ω. The damage level is  $\geq +10\text{V}$  or  $\leq -10\text{V}$ .

## EXT PULSE

This front panel BNC connector accepts an external pulse input which is used in conjunction with the PULSE On/Off function. It is TTL compatible and has an input impedance of 50Ω. The damage level is  $\geq +5.5\text{V}$  or  $\leq -0.5\text{V}$ .

A TTL high input ( $>+2\text{V}$ ) enables the selected amplitude at the **RF OUTPUT** connector. A TTL low level turns the pulse off. (The RF On/Off Ratio is  $>80\text{ dB}$ .) When PULSE NORMAL INVERT is in inverted mode, these states are reversed.

---

**Note** If your instrument has Option 1E2, the functions PULSE NORMAL and PULSE INVERT enable external and external inverted pulse modulation.

---

## RF OUTPUT

The standard (non-optional) front panel **RF OUTPUT** connector is a Type-N precision connector. When option 1E9 is installed, this front panel connector is a 3.5 mm precision connector. The nominal source impedance is 50Ω.

When you make connections to the **RF OUTPUT** connector, carefully align the center conductor elements. Then, rotate the knurled barrel until you make firm contact.

---

**Note** Be careful when you work with this connector. If it is mechanically degraded, high frequency losses can occur. Refer to application note 326, *Coaxial Systems - Principles of Microwave Connector Care* (HP part number 5954-1566) for more details.

---

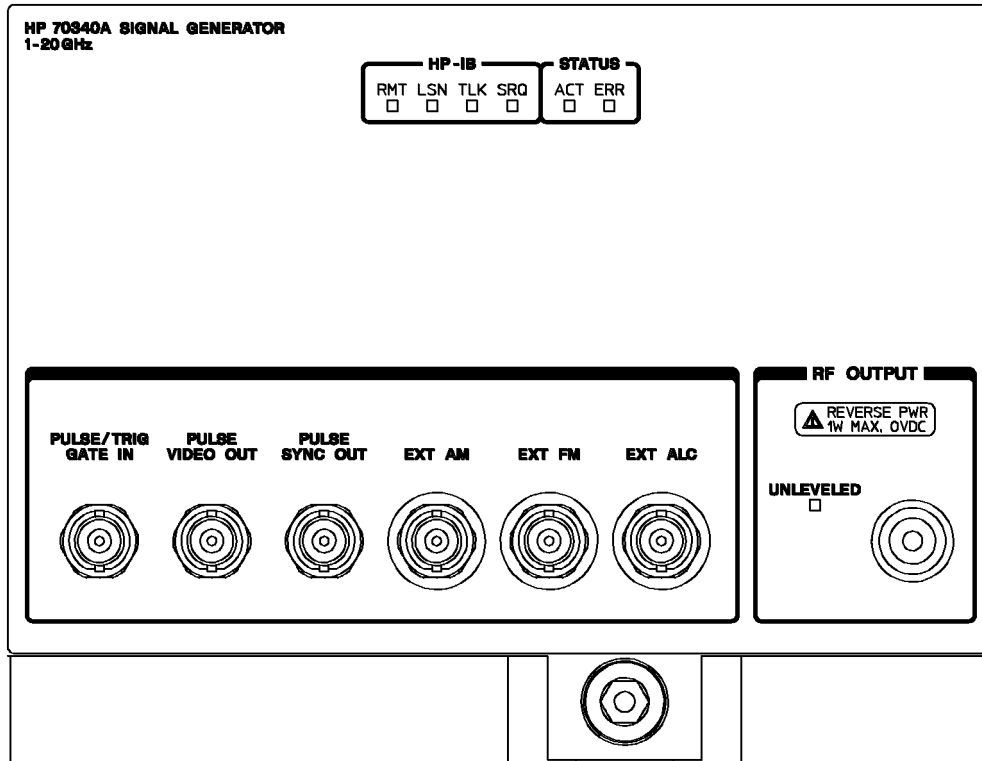

Figure 9-2. HP 70340A Connectors - Option 1E2 Front Panel

### PULSE/TRIG, GATE IN

If your instrument has Option 1E2, this front panel BNC connector can be used as either an external pulse input or an external trigger pulse input for internal pulse modulation. In either case, it is TTL level compatible and has a nominal input impedance of 50Ω. The damage level is  $\geq +5.5\text{V}$  or  $\leq -0.5\text{V}$ .

A TTL high level ( $>+2\text{V}$ ) enables the selected power level to be at the **RF OUTPUT** connector, while a TTL low level turns the pulse off. When inverted external pulse modulation is active, these states are inverted.

In externally triggered pulse mode, a valid TTL level trigger signal causes pulsed RF to appear at the **RF OUTPUT** connector with pulse width and delay set by the PULSE WIDTH and PULSE DELAY functions.

### PULSE SYNC OUT

If your instrument contains Option 1E2, this front panel BNC connector provides a synchronizing signal during internal and triggered pulse modulation. The rising edge of this 50 ns pulse defines the time zero reference for the internal pulse mode delay. In triggered pulse mode, a pulse will occur at this connector nominally 225 ns after the leading edge of the external pulse trigger signal. The nominal source impedance is 50Ω. The pulse amplitude is greater than 2.4 volts into a 50Ω load.

## **PULSE VIDEO OUT**

If your instrument has Option 1E2, this front panel BNC connector provides a synchronizing signal that follows the RF output in all pulse modes. In internal pulse mode, delay is measured from the rising edge of the pulse at the **PULSE SYNC OUT** connector to the rising edge of the pulse at the **PULSE VIDEO OUT** connector. In triggered pulse mode, delay is measured from the rising edge of the pulse at the **PULSE/TRIG, GATE IN** connector to the rising edge of the pulse at the **PULSE VIDEO OUT** connector. The nominal source impedance is  $50\Omega$ . The pulse amplitude is greater than 2.4 volts into a  $50\Omega$  load.



## Connectors- HP 70340A Rear Panel

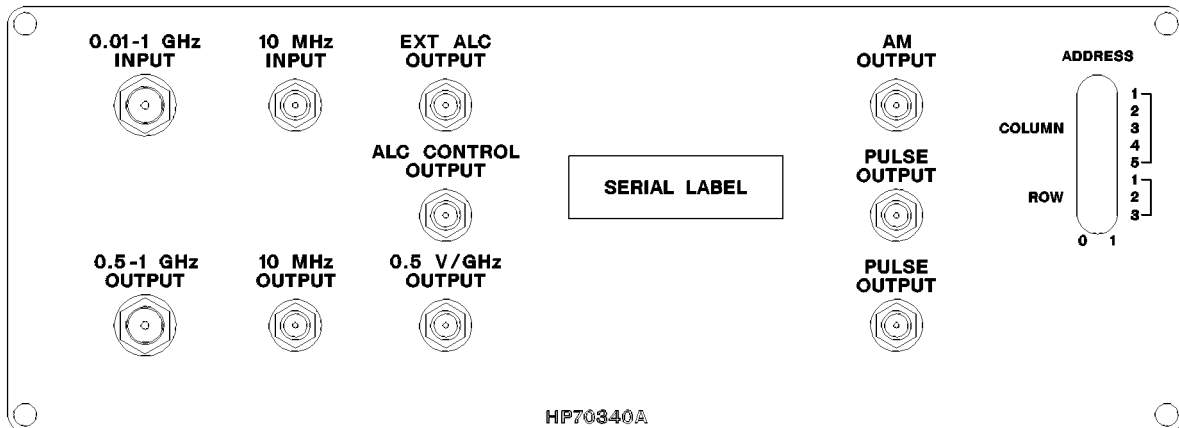

Figure 9-3. HP 70340A Connectors - Rear Panel

### 0.5-1 GHz Output

This SMA connector outputs a 0.5 to 1.0 GHz signal for driving the HP 70341A Frequency Extension module.

### 0.01-1 GHz Input

This SMA connector accepts the HP 70341A 0.01 to 1 GHz output signal. The HP 70341A signal is output step attenuated in the HP 70340A with the 0.01 to 1.0 GHz output available at the front panel output connector of the HP 70340A.

### 10 MHz INPUT

This rear panel SMB connector accepts a 10 MHz, 0 to +10 dBm external reference signal for operation referenced to an external high stability time base. The nominal input impedance of this input is 50Ω. The signal generator detects and automatically switches from internal to external reference operation when a valid reference signal is connected to the 10 MHz INPUT.

### 10 MHz OUTPUT

This rear panel SMB connector provides a +3 dBm, 10 MHz external reference signal for other modules. This signal is derived from the internal frequency standard of the signal generator. The nominal source impedance is 50Ω.

## 0.5 V/GHz OUT

This rear panel SMB connector can be used as one of the inputs to a recorder or for use with mm-wave frequency multipliers, including the HP 835XX Series. It produces a DC voltage output that varies linearly with the frequency currently at the **RF OUTPUT** connector. For example, if the signal generator current frequency setting is 5.5 GHz, the voltage at this connector is 2.75V. The nominal output impedance is 3 k $\Omega$ .

## PULSE OUTPUTS

These two rear panel SMB connector outputs distribute the **EXT PULSE** signal to frequency extension modules. The signals are TTL level compatible (50 $\Omega$  load) pulses.

## EXT ALC OUTPUT

This rear panel SMB connector output distributes the **EXT ALC** signal to frequency extension modules.

## ALC CONTROL OUTPUT

This rear panel SMB connector supplies a  $-10$  to  $+10$  V signal as a reference for leveling the .01 to 1.0 GHz output signal of the HP 70341A.

## AM OUTPUT

This rear panel SMB output distributes the **EXT AM** signal to frequency extension modules.

## HP-MSIB Connector (mainframe)

The **HP-MSIB** mainframe connector provides the high-speed digital bus and HP-IB bus used by the signal generator and other modules for exchanging control information and data. The factory preset HP-MSIB row and column location for the HP 70340A signal generator is Row 0, Column 29.

---

**Note** This connector is on the mainframe, not the HP 70340A or HP 70341A.

---

## HP-IB Connector

The mainframe's rear panel HP-IB connector allows the instrument to be connected to controllers, HP-IB instruments and other modules within the display. The factory preset HP-IB address for the HP 70340A signal generator is 19. Details about this cable are shown in Figure 9-4. HP part numbers for various HP-IB cables that are available are shown in Table 9-2.

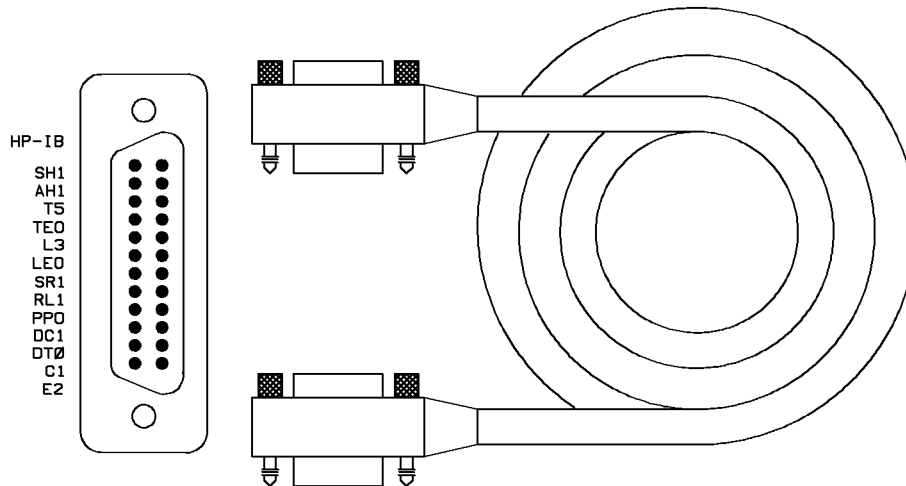

**Figure 9-4. HP-IB Connector and Cable**

**Table 9-2. HP-IB Interface Cables**

| HP-IB Cable Part Number | Length        |
|-------------------------|---------------|
| HP 10883A               | 1m (3.3 ft)   |
| HP 10883B               | 2m (6.6 ft)   |
| HP 10883C               | 4m (13.2 ft)  |
| HP 10883D               | 0.5m (1.6 ft) |

---

**Note** This connector is on the mainframe, not the HP 70340A or HP 70341A.

---

As many as 14 HP-IB instruments can be connected to the signal generator. (There can be 15 total instruments in the system). The cables can be interconnected in a star pattern (one central instrument with the HP-IB cables emanating from that instrument like spokes on a wheel), in a linear pattern (like boxcars on a train), or a combination of the two. There are certain restrictions that must be followed when interconnecting instruments. These restrictions are as follows:

- Each instrument must have a unique HP-IB address, ranging from 0 to 30 (decimal). Refer to “To Set the HP-IB Address” in Chapter 2, “Performing Fundamental Operations,” for more information.
- In a two-instrument system that uses just one HP-IB cable, the cable length must not exceed 4 meters (13.2 ft).
- When more than two instruments are connected on the bus, the cable length of each instrument must not exceed two meters (6.6 ft).
- The total cable length between all instruments must not exceed 20 meters (65 ft).

Hewlett-Packard manufacturers HP-IB extender instruments (Models HP 37201A and HP 37204A/B) that overcome the range limitations imposed by the cabling rules. These extenders allow twin pair cable operation up to 1 km (3,280 ft), and telephone modem operation over any distance. HP sales and service offices can provide additional information on the HP-IB extenders.

The codes next to the HP-IB connector describe the HP-IB interface capabilities of the signal generator, using IEEE Std. 488.1 compatibility codes. (HP-IB, GP-IB, IEEE 488, and IEC-625 are all electrically equivalent.) Briefly, the mnemonics translate as follows:

|     |   |
|-----|---|
| SH1 | Source Handshake, complete capability.                              |
| AH1 | Acceptor Handshake, complete capability.                            |
| T5  | Talker; capable of basic talker, serial poll, and unaddress if MLA. |
| TE0 | Talker, Extended address; no capability.                            |
| L3  | Listener; capable of basic listener and unaddress if MTA.           |
| LE0 | Listener, Extended address; no capability.                          |
| SR1 | Service Request, complete capability.                               |
| RL1 | Remote Local, complete capability.                                  |
| PP0 | Parallel Poll, no capability.                                       |
| DC1 | Device Clear, complete capability.                                  |
| DT0 | Device Trigger, no capability.                                      |
| C1  | Controller capability, system controller.                           |
| E2  | Electrical specification indicating tri-state outputs.              |

These codes are described completely in the IEEE Standard 488 (1978), *IEEE Standard Digital Interface for Programmable Instrumentation* or the identical ANSI Standard MC1.1.

## **Mainframe/Module Interconnect**

The mainframe/module interconnect provides the power supply connection, the HP-MSIB connections, and the HP-IB connections for the signal generator and frequency extension modules.

### **See Also**

Refer to the *HP 70341A Installation Guide* for the module rear panel connectors and connections between the HP 70340A and the HP 70341A. The “Specifications and Options” chapter of this book contains a listing of both the HP 70340A and HP 70341A rear panel connectors.

---

## Electrostatic Discharge Information

Electrostatic discharge (ESD) can damage or destroy electronic components. Therefore, all work performed on assemblies consisting of electronic components should be done at a static-safe workstation.

A static-safe workstation can use two types of ESD protection: 1) conductive table mat and wrist strap combination, and 2) conductive floor mat and heel strap combination. These methods may be used together or separately. (A list of static-safe accessories and their part numbers is given on the following pages.)

### Reducing Damage Caused By ESD

Below are suggestions that may help reduce ESD damage that occurs during testing and servicing instruments.

#### PC Board Assemblies and Electronic Components

Handle these items at a static-safe workstation.

Store or transport these items in static-shielding containers.

---

#### Caution

Do not use erasers to clean the edge connector contacts. Erasers generate static electricity and remove the thin gold plating, which degrades the electrical quality of the contacts.

Do not use paper of any kind to clean the edge connector contacts. Paper or lint particles left on the contact surface can cause intermittent electrical connections.

Do not touch the edge connector contacts or trace surfaces with bare hands. Always handle board assemblies by the edges.

---

PC board assembly edge connector contacts may be cleaned by using a lint-free cloth with a solution of 80% electronics-grade isopropyl alcohol and 20% deionized water. This procedure should be performed at a static-safe workstation.

#### Test Equipment

Before connecting any coaxial cable to an instrument connector for the first time each day, momentarily ground the center and outer conductors of the cable.

Personnel should be grounded with a resistor-isolated wrist strap before touching the center pin of any connector and before removing any assembly from the instrument.

Be sure that all instruments are properly earth-grounded to prevent buildup of static charge.

## Static-Safe Accessories

The following is a list of static-safe accessories that may be obtained from any Hewlett-Packard office by using the HP part numbers listed.

HP Part Number 9300-0797

Includes: 3M static control mat .6m x 1.2m (2 ft. x 4 ft.)  
4.6m (15 ft.) ground wire  
wrist strap and attachment cord

HP Part Number 9300-0980

Wrist strap cord 1.5m (5 ft.)

HP Part Number 9300-0985

Wrist strap (large)

HP Part Number 9300-0986

Wrist strap (small)

HP Part Number 9300-1169

ESD heel strap (reusable 6 to 12 months)

HP Part Number 9300-0793

Shoe ground strap (one-time use only)

---

## Fuse

The metric 6.3A mainframe fuse is HP part number 2110-0703 and is located on the rear panel of the mainframe.

---

A continuity light or an ohmmeter can be used to check that the fuse is good. An ohmmeter should read very close to zero ohms if the fuse is good. Visual inspection of the fuse is not a sure check that the fuse is good.

---

**Warning**      **For continued protection against fire hazard, replace the fuse with one that is the same type and rating.**

---

## See Also

“Power-up Problems” in the chapter, “Installing and Verifying the Signal Generator”

---

## LEDs- HP 70340A and HP 70341A

The LEDs listed here include those that are on the HP 70340A, HP 70341A, your display and/or mainframe. The LEDs are listed in alphabetical order.

### ACT LED

The green front panel HP 70340A and HP 70341A **ACT** (ACTIVE) LED is a STATUS indicator. It illuminates when the instrument controls the keyboard or when it is accessed in a configuration function.

---

It is normal for the front panel LEDs (which include HP-IB LEDs and STATUS LEDs) to turn on and off during an instrument self-test (for instance, at turn-on.)

The signal generator **ACT** LED lights when the cursor of the Address Map (Display screen) is at its HP-MSIB address. You can identify the signal generator (or other module's) HP-MSIB address by scrolling the cursor through the address map and observing when the **ACT** LED is on.

### ERR LED

The HP 70340A and HP 70341A red front panel **ERR** (ERROR) LED is one of the instrument STATUS LEDs. This LED illuminates when there is a problem with the instrument or, possibly, with another component in the MMS.

---

Conditions which generate an error and cause the **ERR** LED to light are listed in "Error Messages".

If the HP 70341A **ERR** LED lights, the module requires service.

The **ERR** LED turns off when the error condition no longer exists and the condition has been reported (read from the front panel error queue). You can report an error by accessing the **REPORT ERRORS** softkey which is under the **DISPLAY** (**DSP**) key menu. Refer to the procedure, "To Check the Error Queue" in Chapter 2, "Performing Fundamental Operations," for details about reading the front panel error queue.

If the HP 70340A **ERR** LED flashes at about a 1 Hz rate, it indicates that the signal generator can not communicate with the HP-MSIB.

### HP-IB LEDs

The four HP 70340A front panel HP-IB LEDs are **LSN**, **SRQ**, **RMT**, and **TLK**. When the signal generator is under the control of an external HP-IB controller, the **RMT** (remote) LED lights. When the signal generator is in remote or local mode, the **LSN** LED and the **TLK** LED indicate whether the signal generator is addressed to "listen" or "talk," respectively. The **SRQ** LED lights during a signal generator generated service request.

---

When HP-IB activity occurs, the **RMT** LED is updated immediately. **TLK**, **LSN**, and **SRQ** are updated only when the signal generator is not busy processing HP-IB traffic. The delay in updating occurs so that the operation speed of the signal generator is not impeded.



It is normal for the front panel LEDs (which include HP-IB LEDs and STATUS LEDs) to turn on and off during an instrument self-test (for instance, at turn-on).

## See Also

**LSN LED**  
**SRQ LED**  
**RMT LED**  
**TLK LED**  
**ERR LED**  
**ACT LED**

## LSN LED

When the HP 70340A front panel HP-IB **LSN** (LISTEN) LED is on, it indicates that the signal generator is addressed to listen to (accept data from) the controller.

---

When the signal generator receives its listen address from the controller, the **LSN LED** lights. The **LSN LED** remains on until the controller sends the signal generator a talk address, a new listen address, an abort message, or a universal unlisten command.

When HP-IB activity occurs, the **LSN LED** is updated only when the signal generator is not busy processing HP-IB traffic. The delay in updating occurs so that the operation speed of the signal generator is not impeded.

It is normal for the front panel LEDs (which include HP-IB LEDs and STATUS LEDs) to turn on and off during an instrument self-test (for instance, at turn-on).

## RMT LED

When the HP 70340A front panel HP-IB **RMT** (REMOTE) LED is on, it indicates the signal generator is under the control of an external HP-IB controller.

---

When HP-IB activity occurs, the **RMT LED** is updated immediately.

It is normal for the front panel LEDs (which include HP-IB LEDs and STATUS LEDs) to turn on and off during an instrument self-test (for instance, at turn-on).

## SRQ LED

When the HP 70340A front panel HP-IB **SRQ** (STATUS REQUEST) LED is on, it indicates that the signal generator is generating a service request to the external controller.

---

The signal generator sets the Service Request (SRQ) bus line to TRUE when it sends a service request. The SRQ bus line clears when the controller executes a serial poll or when the “clear status byte” command is received by the signal generator. The **SRQ LED** is on during the interval that the SRQ bus line is TRUE.

The instrument can send a service request in both local mode and remote mode. In either case, the **SRQ LED** lights. When HP-IB activity occurs, the **SRQ LED** is updated only when

the signal generator is not busy processing HP-IB traffic. This delay in updating occurs so that the operation speed of the signal generator is not impeded.

It is normal for the front panel LEDs (which include HP-IB LEDs and STATUS LEDs) to turn on and off during an instrument self-test (for instance, at turn-on.)

## **STATUS LEDs**

The front panel STATUS LEDs indicate the status of the instrument. Both the HP 70340A and the HP 70341A have STATUS LEDs. The two LEDs are the **ACT** LED and the **ERR** LED.

---

The **ERR** (error) LED lights when there is a problem with the signal generator or with one of the other components in the MMS. To clear the error condition and turn off the LED, refer to the procedure, “To Check the Error Queue,” in the “Performing Fundamental Operations” chapter.

The **ACT** (active) indicates that the signal generator is being used through the display keyboard. This LED does *not* indicate any instrument error conditions.

It is normal for the front panel LEDs (which include HP-IB LEDs and STATUS LEDs) to turn on and off during an instrument self-test (for instance, at turn-on).

## **TLK LED**

When the HP 70340A front panel HP-IB **TLK** (TALK) LED is on, it indicates that the signal generator is addressed to talk (send information) to the controller.

---

When the signal generator receives its talk address from the controller, the **TLK** LED lights. The **TLK** LED remains on until the controller sends the signal generator a listen address, a new talk address, an Abort message, or a universal untalk command.

When HP-IB activity occurs, the **TLK** LED is updated only when the signal generator is not busy processing HP-IB traffic. The delay in updating occurs so that the operation speed of the signal generator is not impeded.

It is normal for the front panel LEDs (which include HP-IB LEDs and STATUS LEDs) to turn on and off during an instrument self-test (for instance, at turn-on).

## **UNLEVELED LED**

This HP 70340A front panel LED illuminates when power at the **RF OUTPUT** connector is not leveled.

---

Specifically, the **UNLEVELED** LED illuminates when the signal generator is set to a power level greater than the maximum leveled power available. It indicates that the power level shown on the display is incorrect.

## See Also

ALC INT

ALC PWR MTR

ALC DIODE

---

## LINE Switch

The LINE Switch on the mainframe or display front panel turns the MMS on and off (as indicated by the green LED adjacent to the switch).

---

The location and operation of the switch varies among mainframes/displays. For instance, the HP 70004A display LINE switch is located on the bottom center of the mainframe. On the other hand, the HP 70206A display LINE switch is located on the bottom left of the front panel.

---

**Warning**      **Before turning the mainframe on, make sure that it is grounded through the protective conductor of the power cable to a socket outlet provided with protective earth contact. Any interruption of the protective grounding conductor inside or outside of the mainframe or disconnection of the protective earth terminal can result in personal injury.**

---

**Caution**      Before turning the mainframe on, set the red LINE Voltage Selector to the voltage of the power source. Failure to do this can cause instrument damage when the power cable is plugged in. Use the LINE Voltage Selector to select a line voltage. The mainframe LINE Voltage Selector switch is located on the mainframe bottom. The LINE Voltage Selector switch for the stand-alone display is located on its rear panel. Refer to the appropriate mainframe or display operating manuals for more information.

---

## See Also

“Installing and Verifying the Signal Generator”  
Power Cable

---

## Module Latch

The module hex-nut latch on the HP 70340A and HP 70341A front panels holds the module in the main-frame. An 8 mm hex-ball driver that is provided with the mainframe turns the module latch when you install or remove the module. The chapter in the “Operation” section, “Installing and Verifying the Signal Generator,” contains instrument installation procedures.

---

**Note**            Always turn the main-frame power off before installing or removing an instrument module.

---

## Power Cable

The MMS mainframe or display is equipped with a three-wire power cable. When connected to an appropriate AC power receptacle, this cable grounds the instrument chassis. The type of power cable shipped depends on the country of destination. See Figure 9-5 or check with your nearest Hewlett-Packard service center for the part numbers of these power cables. Cables are available in different lengths, and some have plugs that are at right angles to the instrument.

**Note** A power cable is *not* shipped with the HP 70340A modular signal generator or the HP 70341A frequency extension module.

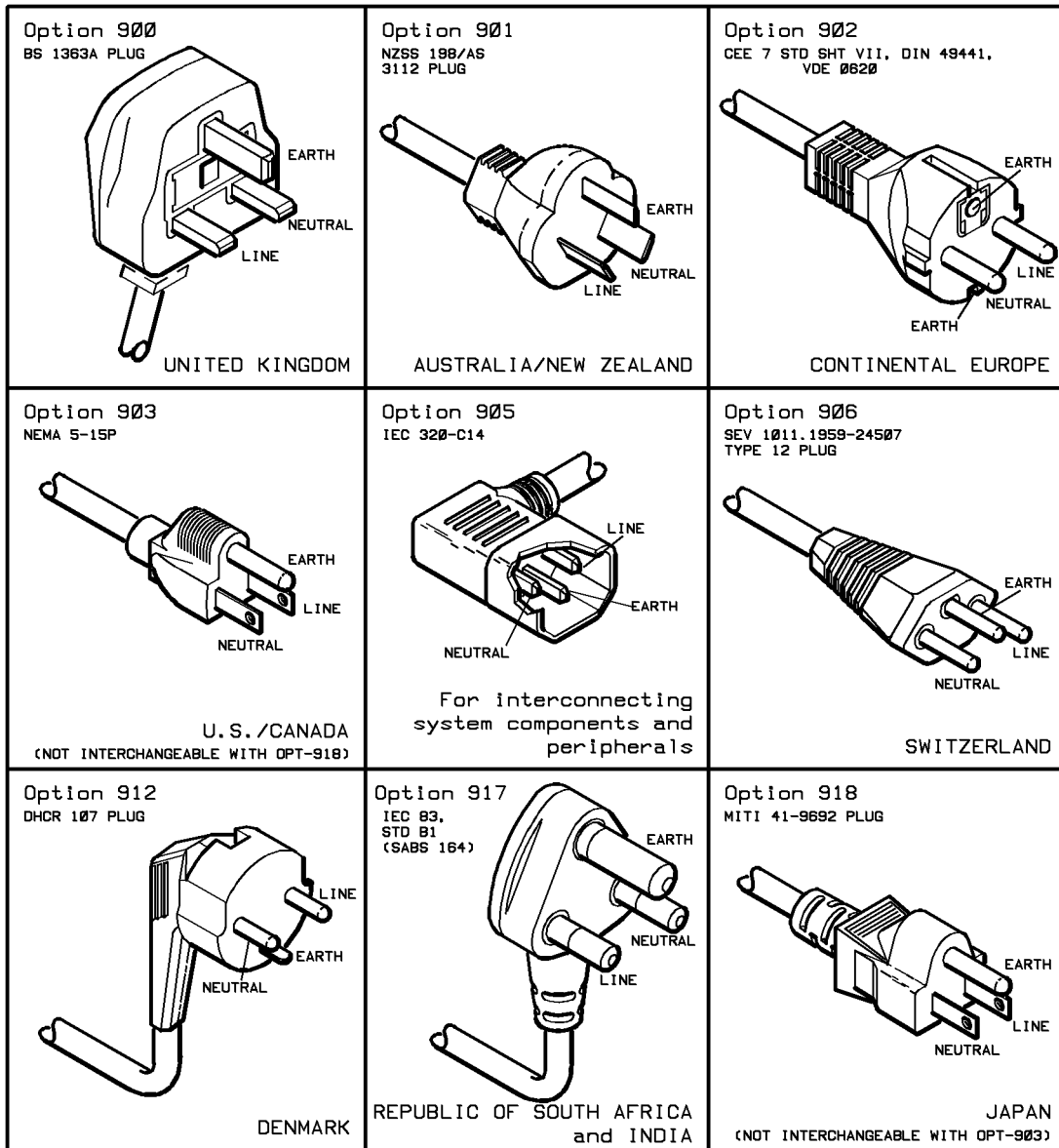

Figure 9-5. Power Cable and Line (Mains) Plug Part Numbers



## **Legal and Regulatory Information**

---

This chapter contains information pertaining to safety, SCPI conformance, and the warranty.



---

## Safety Considerations

This product and related documentation must be reviewed for familiarization with safety markings and instructions before operation.

This product is a Safety Class I system (provided with a protective earth terminal).

### Before Applying Power

Verify that the product is set to match the available line voltage and the correct fuses are installed.

### Safety Earth Ground

An uninterruptable safety earth ground must be provided from the main power source to the product input wiring terminals, power cable, or supplied power cable set.

---

### Warning

**Any interruption of the protective (grounding) conductor (inside or outside the system) or disconnecting the protective earth terminal will cause a potential shock hazard that could result in personal injury. (Grounding one conductor of a two conductor outlet is not sufficient protection.) In addition, verify that a common ground exists between the unit under test and the system prior to energizing either unit.**

**Whenever it is likely that the protection has been impaired, the system must be made inoperative and be secured against any unintended operation.**

**If this system is to be energized via an autotransformer (for voltage reduction) make sure the common terminal is connected to neutral (that is, the grounded side of the mains supply.)**

**Servicing instructions are for use by service-trained personnel only. To avoid dangerous electric shock, do not perform any servicing unless qualified to do so.**

---

---

(cont'd)

**Adjustments described in the manual are performed with power supplied to the system's instruments while protective covers are removed. Energy available at many points may, if contacted, result in personal injury.**

**Capacitors inside the system's instruments might still be charged even if the system has been disconnected from its source of supply.**

**For continued protection against fire hazard, replace the line fuses only with 250V fuses of the same current rating and type (for example, normal blow, time delay, etc.). Do not use repaired fuses or short circuited fuse holders.**

---

## Safety Symbols



Instruction manual symbol: The product will be marked with this symbol when it is necessary for the user to refer to the instruction manual (see Table of Contents for page references).



Indicates hazardous voltages.



Indicates earth (ground) terminal.

---

## Warning

**The WARNING sign denotes a hazard. It calls attention to a procedure, practice, or the like which, if not correctly performed or adhered to, could result in personal injury. Do not proceed beyond a WARNING sign until the indicated conditions are fully understood and met.**

---

## Caution

The CAUTION sign denotes a hazard. It calls attention to a procedure, practice, or the like which, if not correctly performed or adhered to, could result in damage to or destruction of part or all of the product. Do not proceed beyond a CAUTION sign until the indicated conditions are fully understood and met.

---

---

## SCPI Conformance

The Signal Generator uses the SCPI (Standard Commands for Programmable Instruments) language for HP-IB communication. The SCPI commands and queries that the Signal Generator understands are listed and described individually in Chapter 7, “Programming Commands”.

The following table lists all of the commands and queries that the Signal Generator understands and whether they are SCPI approved, SCPI confirmed, or non-SCPI. The commands and queries that are labeled “IEEE 488.2 Required” and “IEEE 488.2 Optional” are always non-SCPI.

---

**Note** In the table, if a command is terminated with a question mark enclosed in parentheses (?), that particular syntax is both a command and a query.

---

Use “SYST:VERS?” to determine the current SCPI version number that the Signal Generator supports.

If you need more information about SCPI, refer to the *Beginner’s Guide to SCPI* (HP part number 5010-7166).

**Table 10-1. SCPI Conformance**

| <b>Programming Command</b>            | <b>Status</b>       |
|---------------------------------------|---------------------|
| *CLS                                  | IEEE 488.2 Required |
| DISPlay[:WINDow][:STATe](?)           | SCPI Confirmed      |
| *DMC                                  | IEEE 488.2 Optional |
| *EMC(?)                               | IEEE 488.2 Optional |
| *ESE(?)                               | IEEE 488.2 Required |
| *ESR?                                 | IEEE 488.2 Required |
| *GMC?                                 | IEEE 488.2 Optional |
| *IDN?                                 | IEEE 488.2 Required |
| INITiate:CONTinuous(?)                | SCPI Confirmed      |
| *LMC?                                 | IEEE 488.2 Optional |
| *LRN?                                 | IEEE 488.2 Optional |
| MEMory:RAM:INITialize                 | Non-SCPI            |
| MEMory:TABLE:SElect(?)                | SCPI-Confirmed      |
| MEMory:TABLE:FREQuency(?)             | SCPI-Confirmed      |
| MEMory:TABLE:FREQuency:POINts?        | SCPI-Confirmed      |
| MEMory:TABLE:LOSS[:MAGNitude](?)      | SCPI-Confirmed      |
| MEMory:TABLE:LOSS[:MAGNitude]:POINts? | SCPI-Confirmed      |
| *OPC(?)                               | IEEE 488.2 Required |
| *OPT?                                 | IEEE 488.2 Optional |
| OUTPut:IMPedance?                     | SCPI Confirmed      |
| OUTPut:PROTection[:STATe](?)          | SCPI Confirmed      |

**Table 10-1. SCPI Conformance (continued)**

| Programming Command                      | Status              |
|--|---------------------|
| OUTPut[:STATe](?)                        | SCPI Confirmed      |
| *PMC                                     | IEEE 488.2 Optional |
| *PSC(?)                                  | IEEE 488.2 Optional |
| *RCL                                     | IEEE 488.2 Optional |
| *RMC                                     | IEEE 488.2 Optional |
| *RST                                     | IEEE 488.2 Required |
| *SAV                                     | IEEE 488.2 Optional |
| [SOURce[1]:]AM:STATe(?)                  | SCPI Confirmed      |
| [SOURce[1]:]AM:TYPE(?)                   | SCPI Confirmed      |
| [SOURce[1]:]CORRection[:STATe](?)        | SCPI Confirmed      |
| [SOURce[1]:]CORRection:CSET[:SElect](?)  | SCPI Confirmed      |
| [SOURce[1]:]CORRection:CSET:STATe(?)     | SCPI Confirmed      |
| [SOURce[1]:]FM:COUPling(?)               | SCPI Confirmed      |
| [SOURce[1]:]FM:SENSitivity?              | SCPI Confirmed      |
| [SOURce[1]:]FM:STATe(?)                  | SCPI Confirmed      |
| [SOURce[1]:]FREQUency[:CW]:FIXed(?)      | SCPI Confirmed      |
| [SOURce[1]:]FREQUency[:CW]:FIXed:STEP(?) | SCPI Confirmed      |
| [SOURce[1]:]FREQUency:MULTiplier(?)      | SCPI Confirmed      |
| [SOURce[1]:]FREQUency:MULTiplier:STEP(?) | SCPI Confirmed      |
| [SOURce[1]:]MODulation:AOff              | Non-SCPI            |
| [SOURce[1]:]MODulation:STATe(?)          | Non-SCPI            |
| [SOURce[1]:]POWer:ALC:PMETer(?)          | Non-SCPI            |

**Table 10-1. SCPI Conformance (continued)**

| <b>Programming Command</b>                | <b>Status</b>       |
|---|---------------------|
| [SOURce[1]:]POWer:ALC:PMETer:STEP(?)      | Non-SCPI            |
| [SOURce[1]:]POWer:ALC:SOURce(?)           | SCPI Confirmed      |
| [SOURce[1]:]POWer:ATTenuation:AUTO(?)     | SCPI Confirmed      |
| [SOURce[1]:]POWer[:LEVel](?)              | SCPI Confirmed      |
| [SOURce[1]:]POWer[:LEVel]:STEP(?)         | SCPI Confirmed      |
| [SOURce[1]:]POWer:PROTection:STATe(?)     | SCPI Confirmed      |
| [SOURce[1]:]PULM:EXTernal:POLarity(?)     | SCPI Confirmed      |
| [SOURce[1]:]PULM:SOURce(?)                | SCPI Confirmed      |
| [SOURce[1]:]PULM:STATe(?)                 | SCPI Confirmed      |
| [SOURce[1]:]PULSe:DELay(?)                | SCPI Confirmed      |
| [SOURce[1]:]PULSe:DELay:STEP(?)           | SCPI Confirmed      |
| [SOURce[1]:]PULSe:DOUBle[:STATe](?)       | SCPI Confirmed      |
| [SOURce[1]:]PULSe:FREQuency(?)            | SCPI Confirmed      |
| [SOURce[1]:]PULSe:FREQuency:STEP(?)       | SCPI Confirmed      |
| [SOURce[1]:]PULSe:PERiod(?)               | SCPI Confirmed      |
| [SOURce[1]:]PULSe:PERiod:STEP(?)          | SCPI Confirmed      |
| [SOURce[1]:]PULSe:TRANSition[:LEADing](?) | SCPI Confirmed      |
| [SOURce[1]:]PULSe:TRANSition:STATe(?)     | SCPI Confirmed      |
| [SOURce[1]:]PULSe:WIDTh(?)                | SCPI Confirmed      |
| [SOURce[1]:]PULSe:WIDTh:STEP(?)           | SCPI Confirmed      |
| [SOURce[1]:]ROSCillator:SOURce?           | SCPI Confirmed      |
| *SRE(?)                                   | IEEE 488.2 Required |

**Table 10-1. SCPI Conformance (continued)**

| <b>Programming Command</b>              | <b>Status</b>       |
|---|---------------------|
| STATus:OPERation:CONDition?             | SCPI Confirmed      |
| STATus:OPERation:ENABLe(?)              | SCPI Confirmed      |
| STATus:OPERation[:EVENT]?               | SCPI Confirmed      |
| STATus:OPERation:NTRansition(?)         | SCPI Confirmed      |
| STATus:OPERation:PTRansition(?)         | SCPI Confirmed      |
| STATus:PRESet                           | SCPI Confirmed      |
| STATus:QUEStionable:CONDition?          | SCPI Confirmed      |
| STATus:QUEStionable:ENABLe(?)           | SCPI Confirmed      |
| STATus:QUEStionable[:EVENT]?            | SCPI Confirmed      |
| STATus:QUEStionable:NTRansition(?)      | SCPI Confirmed      |
| STATus:QUEStionable:PTRansition(?)      | SCPI Confirmed      |
| *STB?                                   | IEEE 488.2 Required |
| SYSTem:COMMunicate:GPIB:ADDRess(?)      | SCPI Confirmed      |
| SYSTem:COMMunicate:GPIB:ADDRess:STEP(?) | SCPI Confirmed      |
| SYSTem:COMMunicate:PMETer:ADDRess(?)    | Non-SCPI            |
| SYSTem:ERRor?                           | SCPI Confirmed      |
| SYSTem:KEY(?)                           | SCPI Confirmed      |
| SYSTem:LANGuage(?)                      | SCPI Confirmed      |
| SYSTem:PRESet                           | SCPI Confirmed      |
| SYSTem:VERSion?                         | SCPI Confirmed      |
| TRIGger[:SEQuence[1] :STARt]:SOURce(?)  | SCPI Confirmed      |
| TRIGger:SEQuence2[:STOP]:SOURce(?)      | SCPI Confirmed      |

**Table 10-1. SCPI Conformance (continued)**

| Programming Command    | Status              |
|------------------------|---------------------|
| *TST?                  | IEEE 488.2 Required |
| UNIT:FREQuency(?)      | SCPI Confirmed      |
| UNIT:POWer :VOLTagE(?) | SCPI Confirmed      |
| *WAI                   | IEEE 488.2 Required |



---

## Warranty

### **CERTIFICATION**

*Hewlett-Packard Company certifies that this product met its published specifications at the time of shipment from the factory. Hewlett-Packard further certifies that its calibration measurements are traceable to the United States National Institute of Standards and Technology, (NIST), to the extent allowed by the Institute's calibration facility, and to the calibration facilities of other International Standards Organization members.*

---

## **WARRANTY**

This Hewlett-Packard instrument product is warranted against defects in material and workmanship for a period of one year from date of shipment. During the warranty period, Hewlett-Packard Company will, at its option, either repair or replace products which prove to be defective.

For warranty service or repair, this product must be returned to a service facility designated by HP. Buyer shall prepay shipping charges to HP and HP shall pay shipping charges to return the product to Buyer. However, Buyer shall pay all shipping charges, duties, and taxes for products returned to HP from another country.

HP warrants that its software and firmware designated by HP for use with an instrument will execute its programming instructions when properly installed on that instrument. HP does not warrant that the operation of the instrument, or software, or firmware will be uninterrupted or error free.

## **LIMITATION OF WARRANTY**

The foregoing warranty shall not apply to defects resulting from improper or inadequate maintenance by Buyer, Buyer-supplied software or interfacing, unauthorized modification or misuse, operation outside of the environmental specifications for the product, or improper site preparation or maintenance.

NO OTHER WARRANTY IS EXPRESSED OR IMPLIED. HP SPECIFICALLY DISCLAIMS THE IMPLIED WARRANTIES OF MERCHANTABILITY AND FITNESS FOR A PARTICULAR PURPOSE.

## **EXCLUSIVE REMEDIES**

THE REMEDIES PROVIDED HEREIN ARE BUYER'S SOLE AND EXCLUSIVE REMEDIES. HP SHALL NOT BE LIABLE FOR ANY DIRECT, INDIRECT, SPECIAL, INCIDENTAL, OR CONSEQUENTIAL DAMAGES, WHETHER BASED ON CONTRACT, TORT, OR ANY OTHER LEGAL THEORY.

## **ASSISTANCE**

*Product maintenance agreements and other customer assistance agreements are available for Hewlett-Packard products.*

*For any assistance, contact your nearest Hewlett-Packard Sales and Service Office. Addresses are provided at the back of this manual.*





# Index

---

## Special characters

, 6-4

## 0

0.01-1 GHz Input, 9-8  
0.01-1 GHz OUTPUT, 4-13  
0.5-1 GHz INPUT, 4-13  
0.5-1 GHz Output, 9-8  
0.5 V/GHz OUT, 9-8  
0B2, 1-2  
0BV, 1-2  
0BW, 1-2  
 through , 6-4

## 1

10 MHz INPUT, 9-8  
10 MHz OUTPUT, 9-8  
1 Hz frequency resolution  
option 1E8, 4-14

## 3

3.5 mm RF output connector  
option 1E9, 4-14

## 8

8 mm Hex ball driver, 1-2



## A

ABORT, 7-58  
accessories  
included, 1-2, 9-2  
(not included), 9-3  
ac coupling, 3-4  
ac fm  
generating, 3-4  
AC FM, 7-62  
active function, 5-79, 6-10  
to deactivate, 6-6  
ACT LED, 9-15  
**Address Map**, 2-9, 6-5  
address setting  
HP-IB, 2-9  
HP-MSIB, 2-10  
address switch, 2-10  
**ADJUST COLUMN**, 2-9

advantages

DC FM, 7-62  
ALC CONTROL OUTPUT, 9-9  
ALC CTRL, 4-13  
**ALC DIODE**, 5-7  
ALC IN connector, vi  
**ALC INT**, 5-9  
**ALC PWR MTR**, 5-11  
ALC source, 7-15  
ALC Unleveled condition, 5-9  
AM OUTPUT, 9-9  
Amplitude menu, vi  
**Amptd**, 5-6  
**AMPTD**, 5-15  
**AMPTD On Off**, 5-17  
ANSI Standard MC1.1, 9-11  
antenna scan patterns, 3-34  
generating, 3-32  
applications  
attenuator hold function, 5-76  
diode detector leveling, 5-7  
ENTRY HOLD function, 5-79  
ERASE MEMORY, 5-80  
external power meter leveling, 5-11  
frequency multiplier, 5-4  
select risetime, 5-92, 5-93  
arrow keys, 2-6  
problems with the, 2-13  
assembly-level service  
documentation set, 4-15  
**ATTEN AutoHld**, 5-76  
attenuator hold function  
advantages, 5-77  
disadvantages, 5-77  
automatic test, vi  
average power sensitive circuitry, 3-15

## B

back space arrow, 6-3  
, vi, 2-2, 6-3  
 and , 5-69, 5-79, 6-2  
book introduction, ix

## C

cables, **9-3**  
**CALIB FLATCOR**, 3-37, **5-18**  
calibration data  
  factory, 7-32  
**CAL YIG OSC**, **5-78**  
carrier deviation, 7-63  
**CLEAR**, 2-3, 5-3  
**CLEAR STATES**, **5-71**  
CLIM, 9-2  
\*CLS, 7-123, 8-1  
component-level service documentation - option  
  OBV, 4-15  
component level service information , 4-15  
condition register, **7-119**  
connectors  
  front panel, **9-4**  
  Option 1E2, 9-6  
  rear panel, 4-12, **9-8**  
**CW FREQ**, **5-3**  
  problems with, 2-14  
cw signal  
  generating, 3-2

## D

data  
  factory calibration, 7-32  
data entry  
  box, 2-2, 2-3, 2-4, 2-6  
  problems with, 2-13  
data entry box, vi  
data entry keys, vi  
**dBm**, 5-15  
DC FM, 7-62  
  advantages, 5-82, 7-62  
  disadvantages, 5-82, 7-62  
delay  
  negative, 5-55  
  positive, 5-55  
deviation  
  carrier, 7-63  
  frequency, 7-63  
dimensions  
  HP 70340A, 4-10  
  HP 70341A, 4-10  
diode detector leveling, 3-27, 9-4  
  advantages, 5-8  
  applications, 5-7  
  disadvantages, 5-8  
diode detector square law region, 5-7, 5-8  
disadvantages  
  DC FM, 7-62  
display, 5-4, 5-79, 6-5, 9-9

  blanking the, 6-6  
  conventions, viii  
  LINE Switch, 9-19  
  problems with the, 2-13  
**DISPLAY**  
  ((DSP)), 6-3, **6-5**  
DISPlay[  
  WINDow][:STATe], 7-58  
display keys, vi  
display module, 6-2  
\*DMC, 7-50  
documentation  
  assembly level service, 1-2  
  component-level service, 1-2  
  extra set, 1-2  
documentation options, 4-14  
doublet pulse, 3-18  
**DOUBLET PULSE**, **5-39**  
doublet pulse modulation timing, 5-39

## E

electrical options, 4-14  
electrostatic discharge, **9-12**  
\*EMC, 7-52  
enable register, **7-119**  
**ENTER**, 5-4  
**ENTRY HOLD**, **5-79**, 6-2, 6-10  
ENTRY HOLD function  
  application of, 5-79  
environmental  
  specifications, 4-10  
**ERASE MEMORY**, **5-80**  
  application of, 5-80  
**ERR LED**, 1-9, 3-41, **9-15**  
error message  
  action required, 8-2  
  detailed description, 8-2  
  hardware failures, 8-2  
  manual error number, 8-2  
  SCPI error message, 8-2  
  SCPI error number, 8-2  
error message format, 8-2  
**Error Messages**, **8-1**  
error messages list, **8-3**  
error queue  
  checking, **2-12**  
  front panel, 8-1  
  HP-IB, 8-1  
errors  
  permanent , 8-1  
  transient , 8-1  
  types, 8-1  
**ESD**, **9-12**  
\*ESE, 7-124

- \*ESR?, 7-126
- event register, **7-119**
- EXT ALC, **9-4**
- EXT ALC OUTPUT, **9-9**
- EXT AM, **9-4**
- externally triggered pulse modulation, 3-12
- external power meter leveling
  - applications, 5-11
- external timebase reference, 7-26
- EXTERN INVERT**, **5-40**
- EXTERN NORMAL**, **5-42**
- EXT FM, **9-4**
- EXT PULSE, **9-5**
- extra user documentation - option 0B2, 4-15

## F

- FACT COR On Off**, **5-81**
- factory calibration data, 7-32
- features, vi
- firmware revision number, 7-23
- FLATCOR On Off**, **5-20**
- flatnes corrctn**, **5-22**
- FLATNES DATA 1**, **5-23**
- FLATNES DATA 2**, **5-23**
- FLATNES DATA 3**, **5-23**
- FLATNES DATA 4**, **5-23**
- FLATNES DATA x, **5-23**
- flatness, 4-4
- flatness correction, 5-28
  - data, 3-40
  - sensor cal factors for, 3-37
  - table, 3-35
- flatness correction calibration, **3-35**
- FM
  - AC, 7-62
  - DC, 7-62
- FM deviation, 9-5
- FM On Off**, **5-44**
- FM sensitivity, 5-37, 5-44
- FM Sensitivity, 5-38
- FM TYPE AC DC**, **5-82**
- Freq**, **5-2**
- FREQ MULT**, 3-24, **5-4**
  - example using, 2-14
  - problems with, 2-14
- frequency
  - range, 5-3
  - resolution, 5-3
- frequency deviation, 7-63
- frequency extension module
  - front panel illustration of, ix

- Frequency menu, vi
- frequency modulation, 4-9
- frequency multiplier
  - applications, 5-4
  - range, 5-4
- frequency multiplier value, 7-20
- frequency range, 4-2
- front panel, 2-1, 2-2
  - control of, 6-11
- function, vi, 2-2, **2-2**
- functional verification, 1-1
- function parameter, 6-2, 6-3
- fuse, **9-14**

## G

- GATED PULSE**, **5-45**
- gated pulse modulation, 3-21
- Generating Signals, **2-14**
- GHz**, 5-3
- \*GMC?, 7-53
- go-to-local command, 6-11

## H

- hard key
  - convention, viii
- hex-ball driver, 9-20
- Hex Nut Latch, vi
- HLD PWR On Off**, **5-83**
- (HOLD)**, 5-79, 6-2, **6-6**, 6-10
- HP-437B**, **5-24**
- HP-438A**, **5-24**
- HP 70004A color display, viii
- HP70100**, **5-24**
- HP 70340A
  - shipment contents, 9-2
- HP 70340A/41A
  - features, vi
- HP 70340A at a Glance, **vi**
- HP 70340A operation
  - performing basic tasks, 2-1
- HP 70341A
  - connectors, 9-1
  - drawing conventions, viii
  - front panel illustration of, ix
  - hardware features, 9-1
  - installation, 1-1
  - shipment contents, 9-2
- HP-IB, 9-11
  - instrument interconnections, 9-10
  - interface capabilities, 9-11
- HP-IB address
  - default setting, 1-5
  - HP 70340A, 2-9

HP-IB ADRSSET, 2-9  
HP-IB Connector, 9-9  
HP-IB LEDs, 9-15  
HP-MSIB, 2-1, 9-11  
HP-MSIB address  
    default setting, 1-4  
    HP 70340A, 2-10  
HP-MSIB Connector, 9-9  
HP xxx, 5-24  
HW CTRL ADDRESS, 5-84  
HW CTRL VALUE, 5-85  
Hz, 5-3

## I

\*IDN?, 7-22  
IEEE Std. 488.1, 9-11  
If You Encounter a Problem  
    generating signals, 3-41  
    Installation or Verification, 1-8  
    signal generator display operation, 2-13  
incoming inspection, 1-1  
INCR SET, 5-67  
initial power meter reading, 7-11  
INITiate  
    CONTinuous, 7-59  
installation  
    HP 70341A, 1-3  
Installing and Verifying the HP 70340A, 1-7  
Installing and Verifying the Signal Generator, x  
Installing the HP 70340A, 1-2  
INSTR PRESET, 5-15, 5-44, 5-67, 5-69, 5-73,  
    5-80, 5-82, 5-89  
    (I-P), 6-7-9  
instrument preset state, 2-8  
instrument state recall, 7-33  
instrument state save, 7-35  
internal leveling  
    advantages, 5-9  
    disadvantages, 5-9  
internal pulse modulation, 3-9  
internal pulse modulation generator  
    option 1E2, 4-14  
INTERN PULSE, 5-47  
In This Book, ix  
introduction  
    manual, ix

## K

key  
    conventions, viii  
kHz, 5-3  
Knob, 2-4, 5-69, 5-79, 6-6, 6-10  
    problems with the, 2-13

Knob -->, 5-69  
Knob <-- , 5-69

## L

LEDs, vi, 9-15  
leveling  
    diode detector, 3-27  
    internal, 3-2  
    power meter, 3-29  
linear AM, 7-61  
LINE Switch, 1-3, 9-19  
line voltage  
    selection of, 1-3  
LINE Voltage, 9-19  
    Selector switch, 9-19  
\*LMC?, 7-54  
LOCAL, 6-11  
    LCL, 6-11  
local lockout state, 6-11  
local operation, 2-1  
LO FREQ, 5-86  
log am, 3-32  
log AM, 9-4  
log AM and pulse modulation  
    generating simultaneous, 3-24  
LOG AM On Off, 5-49  
logarithmic amplitude modulation  
    specifications, 4-9  
\*LRN?, 7-30  
LSN LED, 9-16

## M

Mainframe/Module Interconnect, 9-11  
Mechanical Damage, 1-8  
MEMory  
    RAM:INITialize, 7-32  
    TABLE:FREQuency, 7-38  
    TABLE:FREQuency:POINts?, 7-41  
    TABLE:LOSS[:MAGNitude], 7-42  
    TABLE:LOSS[:MAGNitude]:POINts?, 7-45  
    TABLE:SElect, 7-46  
menu, 2-2, 2-2, 6-3, 6-5  
MENU  
    (MNU), 6-5, 6-12  
menus  
    how to use, 2-2  
METER NODE, 5-87  
MHz, 5-3  
microwave connector care, 9-5  
millimeter signals  
    generating, 3-24  
M-, 6-4  
Misc, 5-76

mnemonics

user's guide, viii

**Modify Step**, 5-66

problems with, 2-13

Modular Measurement System, 2-1

modulation, 4-7

modulation index, 5-82, 7-62

modulation inputs

connectors, vi

Modulation menu, vi

module, 2-1

Module Latch, 9-20

**Modultn**, 5-36

**MORE 1 OF 2**, 2-2

**MORE 1 of 3**, 2-2

**MORE ERRORS**, 2-12

multiplier value, 7-20

## N

negative delay, 5-55

negative transition register, 7-119

number of points, 7-41, 7-45

numeric keypad, 2-3, 5-3, 5-4, 5-15, 6-6

problems with the, 2-13

## O

**OFFSET FREQ**, 5-88

\*OPC, 7-100

OPT?, 7-24

option

0B2, 9-2

0BV, 9-2

0BW, 9-2

Option

0B2, 1-2

0BV, 1-2

0BW, 1-2

option 0B2 - extra user documentation, 4-15

option 0BV - add component-level service documentation, 4-15

option 0BW - add assembly-level service documentation, 4-15

Option 1E1, 5-15

option 1E1 - add output step attenuator, 4-14

option 1E2

internal pulse modulation generator, 4-14

option 1E8

1 Hz frequency resolution, 4-14

option 1E9

3.5 mm RF output connector, 4-14

option numbers, 7-24

options, 4-1

documentation, 4-14

electrical, 4-14

warranty, 4-14

Option W30, 4-14

Option W32, 4-14

Option W34, 4-14

OUTPut

IMPedance?, 7-25

PROtection[:STATe], 7-111

OUTPut[

STATe], 7-113

output step attenuator - option 1E1, 4-14

## P

parameter

numeric value, 2-3, 2-4, 2-6

performance tests, 1-7

Performing Fundamental Operations, 2-1

permanent errors, 8-1

**PLOT**, 6-5

\*PMC, 7-55

**POINTS**, 5-25

positive delay, 5-55

positive transition register, 7-119

power

level accuracy of, 4-3

maximum leveled output, 4-3

minimum leveled output, 4-3

power cable, 9-2

Power Cable, 9-21

**power meter**, 5-27

power meter leveling, 3-29, 5-29, 9-4

advantages, 5-12

applications, 5-12

disadvantages, 5-12

power meter leveling equipment limitations, 5-12

power supply, 2-1, 9-11

power sweep

generating, 3-6

Power-up

problems, 1-8

preset conditions, 6-7, 7-34, 7-36

preset state, 2-8, 7-34, 7-36

**PRF**, 5-51

**PRI**, 5-53

**PRINT**, 6-5

problems

 , 2-13

clearing the ERR LED, 3-41

**CW FREQ**, 2-14

data entry, 2-13

display, 2-13

Knob, 2-13



- Modify Step**, 2-13
- no underscore, 2-13
- numeric keypad, 2-13
- RF OUTPUT, 3-41
- UNLEVELED LED, 3-41
- programming
  - HP 8673 Series mnemonics, 7-3
  - specifications, 4-10
- programming commands, **7-1**
  - syntax conventions, 7-2
- \*PSC, 7-128
- PULSE DELAY**, 5-55
- pulsed power pre-calibration program, 5-89
- PULSE INPUT, 4-13
- Pulse Modulated Signal
  - generating, **3-15**
- pulse modulation, 3-15, 3-32
  - doublet, 5-39
    - generating doublet, 3-18
    - generating external, 3-15
    - generating externally triggered, 3-12
    - generating gated, 3-21
    - generating internal, 3-9
    - specifications, 4-7
- pulse modulation and log AM
  - generating simultaneous, 3-24
- pulse modultn**, 5-56
- PULSE NML INV**, 5-57
- PULSE OFF**, 5-59
- PULSE On Off**, 5-61, 9-5
- PULSE OUTPUTS, 9-9
- pulse source
  - specifications, 4-8
- PULSE SYNC OUT connector, 9-6
- PULSE/TRIG, GATE IN connector, 9-6
- PULSE VIDEO OUT connector, 9-6
- PULSE WIDTH**, 5-63
- PWR LIM On Off**, 5-89
- PWR MTR ADDRESS**, 3-36, 5-28
- PWR MTR READING**, 3-30, 5-29

## Q

- Questionable Data status group, **7-121**

## R

- range hold power, 5-29
- \*RCL, 7-33
- rear panel connectors
  - specifications, 4-12
- recall instrument state, 7-33
- RECALL STATE**, 2-8, 5-72

- Recorder Output (power meter), 7-11
- remote operation, 2-1
- REN bus control, 6-11
- REPORT ERRORS**, 2-12, 6-5, 9-15
- revision number
  - firmware, 7-23
- RF OUPUT connector, vi
- RF OUTPUT, **9-5**
  - problems with, 3-41
- RISETIME MANAUTO**, 5-92
- RISETIME xxx**, 5-93
- \*RMC, 7-56
- RMT LED, **9-16**
- \*RST, 7-34

## S

- \*SAV, 7-35
- Save and Recall States, **2-8**
- save instrument state, 7-35
- SAVE STATE**, 2-8, 5-73
- SCPI conformance table, 10-4-9
- SCPI PWR MTR**, 5-30
- SCPI version number, 7-28
- SELECT INSTR**, 6-5
- select risetime
  - applications, 5-92
- self test, 1-7
  - failures, 1-9
- SELF TEST**, 5-95
- self test error condition, 1-7
- sensitivity, 7-63
- serial number, 7-23
- service**, 5-97
- service documentation
  - assembly level, 1-2
  - component-level, 1-2
- service documentation, 4-15
- service documentation -
  - component-level option 0BV, 4-15
- service documentation - assembly-level, 4-15
- service documentation - option 0BV, 4-15
- shipment contents
  - HP 70340A, 9-2
  - HP 70341A, 9-2
- SHOW INFO**, 5-98
- SHOW OPTION**, 5-99
- single-module instrument, 2-1
- softkey, 5-76, 5-80
  - convention, viii
- source
  - ALC, 7-15
- [SOURce[1]

- ]AM:STATe, 7-60
- ]AM:TYPE, 7-61
- ]CORRection:CSET[:SElect], 7-47
- ]CORRection:CSET:STATe, 7-48
- ]CORRection[:STATe], 7-49
- ]FM:COUPLing, 7-62
- ]FM:SENSitivity?, 7-63
- ]FM:STATe, 7-64
- ]FREQUency[:CW]:FIXed], 7-16
- ]FREQUency[:CW]:FIXed]:STEP, 7-18
- ]FREQUency:MULTiplier, 7-20
- ]FREQUency:MULTiplier:STEP, 7-22
- ]MODulation:AOffF, 7-65
- ]MODulation:STATe, 7-67
- ]POWer:ALC:PMETer, 7-11
- ]POWer:ALC:PMETer:STEP, 7-13
- ]POWer:ALC:SOURce, 7-15
- ]POWer:ATTenuation:AUTO, 7-114
- ]POWer[:LEVel], 7-95
- ]POWer[:LEVel]:STEP, 7-97
- ]POWer:PROTection:STATe, 7-116
- ]PULM:EXTernal:POLarity, 7-68
- ]PULM:SOURce, 7-69
- ]PULM:STATe, 7-70
- ]PULSe:DELay, 7-71
- ]PULSe:DELay:STEP, 7-73
- ]PULSe:DOUBle[:STATe], 7-75
- ]PULSe:FREQUency, 7-76
- ]PULSe:FREQUency:STEP, 7-78
- ]PULSe:PERiod, 7-80
- ]PULSe:PERiod:STEP, 7-82
- ]PULSe:TRANSition[:LEADing], 7-84
- ]PULSe:TRANSition:STATe, 7-86
- ]PULSe:WIDTh, 7-88
- ]PULSe:WIDTh:STEP, 7-90
- ]ROSCillator:SOURce?, 7-26
- specifications, 1-7, 4-1
  - rear panel connectors, 4-12
- Specifications and Options, 4-1
- spectral purity, 4-4
- square law region
  - diode detector, 5-7, 5-8
- \*SRE, 7-129
- SRQ LED, 9-16
- Standard Event Status group, 7-120
- Standard Operation status group, 7-120
- START FREQ**, 5-31
- State**, 5-70
- State menu, vi
- STATus
  - OPERation:CONDition?, 7-130
  - OPERation:ENABle, 7-131
  - OPERation[:EVENT]?, 7-133
  - OPERation:NTRansition, 7-135

- OPERation:PTRansition, 7-137
- PRESet, 7-139
- QUEStionable:CONDition?, 7-140
- QUEStionable:ENABle, 7-142
- QUEStionable[:EVENT]?, 7-145
- QUEStionable:NTRansition, 7-148
- QUEStionable:PTRansition, 7-151
- Status Byte group, 7-119
- status group, 7-118
- STATUS LEDs, 9-17
- Status Register, 7-118
- Status Register System
  - programming example, 7-121
- \*STB?, 7-154
- STOP FREQ**, 5-33
- submenu, vi, 2-2
- supplemental characteristics, 4-2
- syntax
  - command, 7-2
- syntax conventions, 7-2
- SYSTem
  - COMMunicate:GPIB:ADDRess, 7-100
  - COMMunicate:GPIB:ADDRess:STEP, 7-102
  - COMMunicate:PMETer:ADDRess, 7-50
  - ERRor?, 7-27
  - LANGuage, 7-103
  - PRESet, 7-36
  - PTHROUGH:ADDRess, 7-104
  - PTHROUGH[:STRing], 7-103
  - VERSIon?, 7-28

## T

- timebase reference, 7-26
- timing
  - doublet pulse modulation, 5-39
  - gated pulse modulation, 5-45
  - triggered pulse modulation, 5-64
- TLK LED, 9-17
- To Check the Error Queue, 2-12
- To Enter Data with the Numeric Keypad, 2-3
- To Generate a CW Signal, 3-2
- To Generate a Doublet Pulse, 3-18
- To Generate an AC FM Signal, 3-4
- To Generate a Power Sweep, 3-6
- To Generate Externally Triggered Pulse Modulation, 3-12
- To Generate External Pulse Modulation, 3-15
- To Generate Gated Pulse Modulation, 3-21
- To Generate Internal Pulse Modulation, 3-9
- To Generate Millimeter Signals, 3-24
- To Generate Simultaneous Log AM and Pulse Modulation, 3-24, 3-32
- To Modify Data with the Arrow Keys, 2-6
- To Modify Data with the Knob, 2-4

To Set the HP 70340A HP-IB Address, **2-9**  
To Use External Diode Detector Leveling, 3-27  
To Use External Power Meter Leveling, 3-29  
To Use Previously Stored Flatness Correction  
Data, 3-40  
To Use the Flatness Correction Routine, 3-35  
To Use the Menus, 2-2  
**TRACE SLAVE**, **5-100**  
transient errors, 8-1  
TRIGger  
    SEQuence2, 7-93  
TRIGger[  
    SEQuence[1], 7-92  
triggered pulse modulation timing, 5-64  
**trigger pulse**, **5-64**  
**TRIGGER PULSE**, **5-64**  
\*TST?, 7-29

## **U**

underscore  
    problems with, 2-13  
UNIT

FREQuency, 7-104  
POWer, 7-107  
TIME, 7-109  
units terminator, 5-3  
Unleveled condition  
    ALC, 5-9  
UNLEVELED LED, 3-41, **9-17**  
**USER**, **6-13**  
    **USR**, 6-13  
user documentation , 4-15

## **V**

Verifying HP 70340A/41A Functionality, 1-7  
Verifying HP 70340A Functionality, 1-7  
version number  
    SCPI, 7-28

## **W**

\*WAI, 7-111  
warranty options, 4-14